



Humber Station Villages Landowners Group

TRANSPORTATION MOBILITY PLAN

**Humber Station Employment Area
Secondary Plan
Town of Caledon**

October 2023
23347

**HUMBER STATION VILLAGES
LANDOWNERS GROUP**



LEA Consulting Ltd.

625 Cochrane Drive, 9th Floor
Markham, ON, L3R 9R9 Canada
T | 905 470 0015 F | 905 470 0030
WWW.LEA.CA

October 23, 2023

Reference Number: 23347

Humber Station Villages Landowners Group

c/o Delta Urban Inc.
8800 Dufferin Street, Suite 104
Vaughan, ON L4K 0C5

**RE: Transportation Mobility Plan
Humber Station Employment Area Secondary Plan
Town of Caledon**

LEA Consulting Ltd. is pleased to present the findings of our Transportation Mobility Plan for the Humber Station Employment Area Secondary Plan lands in the Town of Caledon. This Transportation Mobility Plan has been prepared for the Humber Station Villages Landowners Group in support of the Secondary Planning process for development of the Humber Station Employment Area lands. This report concludes that the traffic associated with the secondary plan lands will have an acceptable impact on the surrounding road network, with minor optimizations for the network.

Please do not hesitate to contact the undersigned should you have any additional questions or concerns at (905) 470-0015.

Yours truly,

LEA CONSULTING LTD.

Christopher Sidlar, M.Sc.Pl., MCIP, RPP
Vice-President, Transportation

Encl. Transportation Mobility Plan – Humber Station Employment Area Secondary Plan, Town of Caledon
(October 2023)

Disclaimer

This Report represents the work of LEA Consulting Ltd (“LEA”). This Report may not be relied upon for detailed implementation or any other purpose not specifically identified within this Report. This Document is confidential and prepared solely for the use of the Humber Station Villages Landowners Group. Neither LEA, its sub-consultants nor their respective employees assume any liability for any reason, including, but not limited to, negligence, to any party other than the Humber Station Villages Landowners Group for any information or representation herein.

TABLE OF CONTENTS

1	Introduction.....	1
1.1	Study Area	1
1.2	Humber Station Employment Area Land Use Plan.....	2
2	Policy Context & Background Studies	5
2.1	Provincial Policy Framework.....	5
2.1.1	Provincial Policy Statement (2020)	5
2.1.2	A Place to Grow - Growth Plan for the Greater Golden Horseshoe (2020)	5
2.1.3	Provincial Planning Statement (Proposed 2023).....	5
2.1.4	Highway 413 Transportation Corridor Route Planning and Environmental Assessment Study	6
2.2	Regional Policy Framework	7
2.2.1	Region of Peel Official Plan (2022)	7
2.2.2	Bolton Residential Expansion Study & Regional Official Plan Amendment (ROPA 30)	7
2.2.3	Peel Region Long Range Transportation Plan (2019)	8
2.3	Local Policy Framework.....	10
2.3.1	Town of Caledon Official Plan (2018)	10
2.3.2	Future Caledon: Official Plan (Draft 2023).....	10
2.3.3	Caledon Transportation Master Plan (2017).....	10
2.3.4	Caledon Multi-Modal Transportation Master Plan (On-going).....	11
2.3.5	Caledon Active Transportation Master Plan (On-going).....	11
2.3.6	Transportation Network Feasibility Study - Option 6 and Triangle Lands (2023)	11
2.4	Municipal Class Environmental Assessment.....	12
2.4.1	Highway 427 Industrial Secondary Plan Area (Area 47)	12
3	Existing Transportation Conditions.....	14
3.1	Existing Road Network	14
3.2	Existing Transit Network	16
3.3	Existing Cycling Network	18
3.3.1.1	Cycling Multimodal Level of Service Evaluation	18
3.4	Existing Pedestrian Network.....	19
3.4.1.1	Pedestrian Multimodal Level of Service Evaluation	20

3.5	Traffic Data Collection.....	21
3.6	Existing Synchro Model Inputs.....	22
3.7	Existing Traffic volumes.....	22
4	Future Background Transportation Conditions	23
4.1	Background Developments.....	23
4.2	Corridor Growth.....	24
4.3	Planned External Road Netowrk.....	25
4.4	Planned Transit and Active Transportation Improvements.....	28
4.5	Future Background Synchro Model Inputs	30
4.6	Future Background Traffic Volumes.....	31
5	Site-Generated Traffic.....	33
5.1	Trip Generation.....	33
5.2	Trip Distribution and Assignment	35
6	Future Total Transportation Conditions.....	39
6.1	Internal Network Development	39
6.2	Future Total Synchro Model Inputs.....	41
6.3	Future Total Traffic Volumes	41
7	Intersection Capacity Analysis	44
7.1	Existing Signalized Intersections	44
7.1.1	Coleraine Drive & Healey Road	44
7.1.2	Clarkway Drive/Humber Station Road & Mayfield Road	47
7.1.3	Coleraine Drive & Mayfield Road	51
7.1.4	Coleraine Drive & Private Access/George Bolton Parkway	54
7.1.5	Highway 50 & Private Access/George Bolton Parkway	56
7.2	Future Signalized Intersections.....	58
7.2.1	Humber Station Road & Healey Road.....	58
7.2.2	Triangle Lands Access & Mayfield Road	61
7.2.3	Arterial A2 & Mayfield Road	62
7.2.4	Humber Station Road & George Bolton Parkway (Subject Lands Site Access 1)	64
7.2.5	Subject Lands Site Access 4 & Healey Road	65
7.3	Existing Unsignalized Intersections.....	66
7.3.1	Humber Station Road & Healey Road.....	67

7.4	<i>Future Unsignalized Intersections</i>	67
7.4.1	Triangle Lands Access & Mayfield Road	67
7.4.2	Humber Station Road & George Bolton Parkway (Subject Lands Site Access 1)	68
7.4.3	Subject Lands Site Access 2 & Humber Station Road	69
7.4.4	Subject Lands Site Access 3 & Humber Station Road	70
7.4.5	Subject Lands Site Access 4 & Healey Road	71
7.4.6	Subject Lands Site Access 5 & Mayfield Road	72
7.5	<i>Summary of Intersection Capacity Analysis Results</i>	73
8	Transportation Demand Management	74
8.1	<i>What is TDM?</i>	74
8.2	<i>How Are TDM Goals Achieved?</i>	74
8.3	<i>TDM Benefits</i>	74
8.4	<i>Potential TDM Strategies</i>	75
9	Conclusion	77

LIST OF TABLES

Table 1-1:	Proposed Density by Phase	2
Table 3-1:	Existing Transit Service	16
Table 3-2:	Existing Bicycle Level of Service (BLOS)	19
Table 3-3:	Existing Pedestrian Level of Service (PLOS)	21
Table 3-4:	Data Collection Summary	21
Table 4-1:	Background Developments	23
Table 4-2:	Corridor Growth Summary	24
Table 4-3:	Future Transportation Network Improvements	25
Table 5-1:	Trip Generation (Auto Trips).....	33
Table 5-2:	Trip Generation (Truck Trips).....	34
Table 5-3:	Trip Distribution	35
Table 7-1:	Signal Timing Optimizations, Coleraine Drive & Healey Road	44
Table 7-2:	Intersection Capacity Analysis, Coleraine Drive & Healey Road (2028)	45
Table 7-3:	Intersection Capacity Analysis, Coleraine Drive & Healey Road (2033)	45

Table 7-4: Intersection Capacity Analysis, Coleraine Drive & Healey Road (2043)	46
Table 7-5: Signal Timing Optimizations, Clarkway Drive/Humber Station Road & Mayfield Road	48
Table 7-6: Intersection Capacity Analysis, Clarkway Drive/Humber Station Road & Mayfield Road (2028)	48
Table 7-7: Intersection Capacity Analysis, Clarkway Drive/Humber Station Road & Mayfield Road (2033)	49
Table 7-8: Intersection Capacity Analysis, Clarkway Drive/Humber Station Road & Mayfield Road (2043)	50
Table 7-9: Signal Timing Optimizations, Coleraine Drive & Mayfield Road	51
Table 7-10: Intersection Capacity Analysis, Coleraine Drive & Mayfield Road (2028)	52
Table 7-11: Intersection Capacity Analysis, Coleraine Drive & Mayfield Road (2033)	52
Table 7-12: Intersection Capacity Analysis, Coleraine Drive & Mayfield Road (2043)	53
Table 7-13: Intersection Capacity Analysis, Coleraine Drive & Private Access/George Bolton Parkway (2028)	54
Table 7-14: Intersection Capacity Analysis, Coleraine Drive & Private Access/George Bolton Parkway (2033)	55
Table 7-15: Intersection Capacity Analysis, Coleraine Drive & Private Access/George Bolton Parkway (2043)	55
Table 7-16: Intersection Capacity Analysis, Highway 50 & Private Access/George Bolton Parkway (2028)	56
Table 7-17: Intersection Capacity Analysis, Highway 50 & Private Access/George Bolton Parkway (2033)	57
Table 7-18: Intersection Capacity Analysis, Highway 50 & Private Access/George Bolton Parkway (2043)	57
Table 7-19: Recommended Signal Timing Plan, Humber Station Road & Healey Road	59
Table 7-20: Intersection Capacity Analysis, Humber Station Road & Healey Road (2028)	59
Table 7-21: Intersection Capacity Analysis, Humber Station Road & Healey Road (2033)	60
Table 7-22: Intersection Capacity Analysis, Humber Station Road & Healey Road (2043)	60
Table 7-23: Recommended Signal Timing Plan, Triangle Lands Access & Mayfield Road	61
Table 7-24: Intersection Capacity Analysis, Triangle Lands Access & Mayfield Road (2043)	62
Table 7-25: Recommended Signal Timing Plan, Arterial A2 & Mayfield Road.....	63
Table 7-26: Intersection Capacity Analysis, Arterial A2 & Mayfield Road (2043)	63

Table 7-27: Recommended Signal Timing Plan, Humber Station Road & George Bolton Parkway (Subject Lands Site Access 1)	64
Table 7-28: Intersection Capacity Analysis, Humber Station Road & George Bolton Parkway (Subject Lands Site Access 1) (2033)	64
Table 7-29: Intersection Capacity Analysis, Humber Station Road & George Bolton Parkway (Subject Lands Site Access 1) (2043)	65
Table 7-30: Recommended Signal Timing Plan, Subject Lands Site Access 4 & Healey Road	66
Table 7-31: Intersection Capacity Analysis, Subject Lands Site Access 4 & Healey Road (2043)	66
Table 7-32: Intersection Capacity Analysis, Humber Station Road & Healey Road (Existing)	67
Table 7-33: Intersection Capacity Analysis, Triangle Lands Access & Mayfield Road (2028)	67
Table 7-34: Intersection Capacity Analysis, Triangle Lands Access & Mayfield Road (2033)	68
Table 7-35: Intersection Capacity Analysis, Humber Station Road & George Bolton Parkway (Subject Lands Site Access 1) (2028)	69
Table 7-36: Intersection Capacity Analysis, Subject Lands Site Access 2 & Humber Station Road (2033) .	69
Table 7-37: Intersection Capacity Analysis, Subject Lands Site Access 2 & Humber Station Road (2043) .	70
Table 7-38: Intersection Capacity Analysis, Subject Lands Site Access 3 & Humber Station Road (2033) .	70
Table 7-39: Intersection Capacity Analysis, Subject Lands Site Access 3 & Humber Station Road (2043) .	71
Table 7-40: Intersection Capacity Analysis, Subject Lands Site Access 4 & Healey Road (2033)	72
Table 7-41: Intersection Capacity Analysis, Subject Lands Site Access 5 & Mayfield Road (2033)	72
Table 7-42: Intersection Capacity Analysis, Subject Lands Site Access 5 & Mayfield Road (2043)	73

LIST OF FIGURES

Figure 1-1: Study Area and Subject Lands	1
Figure 1-2: Proposed Land Use Plan	3
Figure 1-3: Humber Station Employment Area Lands Parcel Mapping	4
Figure 2-1: Highway 413 Technically Preferred Route and Interchange Locations	7
Figure 2-2: Road Widening, Region of Peel 2031 and 2041 (LRTP)	9
Figure 2-3: Transportation Network Feasibility Study Recommended Road Network (Option 3)	12
Figure 2-4: Proposed Roadways within Highway 427 Industrial Secondary Plan Area (Area 47)	13
Figure 3-1: Existing Road Network and Lane Configuration	15

Figure 3-2: GO Transit Route 38.....	17
Figure 3-3: Bolton Local Transit Route	17
Figure 3-4: Existing and Planned Cycling Network.....	18
Figure 3-5: Existing Pedestrian Network	20
Figure 3-6: Existing Peak Hour Traffic Volumes	22
Figure 4-1: Background Development Locations	24
Figure 4-2: 2043 Future Background Road Network.....	27
Figure 4-3: Future Transit Network.....	28
Figure 4-4: Future Local Cycling Network.....	29
Figure 4-5: Future Regional Cycling Network	29
Figure 4-6: 2028 Future Background Peak Hour Traffic Volumes.....	31
Figure 4-7: 2033 Future Background Peak Hour Traffic Volumes.....	32
Figure 4-8: 2043 Future Background Peak Hour Traffic Volumes.....	32
Figure 5-1: Total Site-Generated Auto Peak Hour Traffic Volumes (Phase 1 - 2028).....	36
Figure 5-2: Total Site-Generated Truck Peak Hour Traffic Volumes (Phase 1 - 2028).....	36
Figure 5-3: Total Site-Generated Auto Peak Hour Traffic Volumes (Full Buildout - 2033)	37
Figure 5-4: Total Site-Generated Truck Peak Hour Traffic Volumes (Full Buildout - 2033)	37
Figure 5-5: Total Site-Generated Auto Peak Hour Traffic Volumes (Full Buildout - 2043)	38
Figure 5-6: Total Site-Generated Truck Peak Hour Traffic Volumes (Full Buildout - 2043)	38
Figure 6-1: 2043 Future Road Network	40
Figure 6-2: 2028 Future Total Peak Hour Traffic Volumes	42
Figure 6-3: 2033 Future Total Peak Hour Traffic Volumes	42
Figure 6-4: 2043 Future Total Peak Hour Traffic Volumes	43

APPENDICES

APPENDIX A	MMLOS
APPENDIX B	TMCS & STPS
APPENDIX C	BACKGROUND DEVELOPMENTS

APPENDIX D	CORRIDOR GROWTH CALCULATIONS
APPENDIX E	MAYFIELD WIDENING CORRESPONDENCES
APPENDIX F	TTS DATA
APPENDIX G	LOS DEFINITIONS
APPENDIX H	EXISTING INTERSECTION CAPACITY ANALYSIS
APPENDIX I	FUTURE BACKGROUND (2028, 2033, 2043) INTERSECTION CAPACITY ANALYSIS
APPENDIX J	FUTURE TOTAL (2028, 2033, 2043) INTERSECTION CAPACITY ANALYSIS

1 INTRODUCTION

LEA Consulting Ltd. was retained by the Humber Station Villages Landowners Group (“Landowners Group”) to undertake a Transportation Mobility Plan for the Humber Station Employment Area lands (Option 6 lands) (“subject site”) generally situated northeast of Mayfield Road & Humber Station Road and southwest of Healey Road & Coleraine Drive in the Town of Caledon, Ontario (“Town”).

It is understood that the Landowners Group is undertaking a Secondary Planning process for developing the Humber Station Employment Area lands. The purpose of the Secondary Plan is to guide development within the Humber Station Employment Area and prepare a land use plan to support employment investment. This Transportation Mobility Plan forms support for the Secondary Plan study and development of the transportation network in the area.

1.1 STUDY AREA

The Humber Station Employment Area lands includes approximately 207 hectares of total land located generally west of Coleraine Drive in Bolton, Caledon. The study area included within this assessment is generally bounded by Humber Station Road to the west, Mayfield Road to the south, Healey Road to the north, and Highway 50 to the east. The Humber Station Employment Area lands are owned by various participating owners of the Landowners Group, as well as non-participating owners. The study area and subject lands are illustrated in **Figure 1-1**.

Figure 1-1: Study Area and Subject Lands

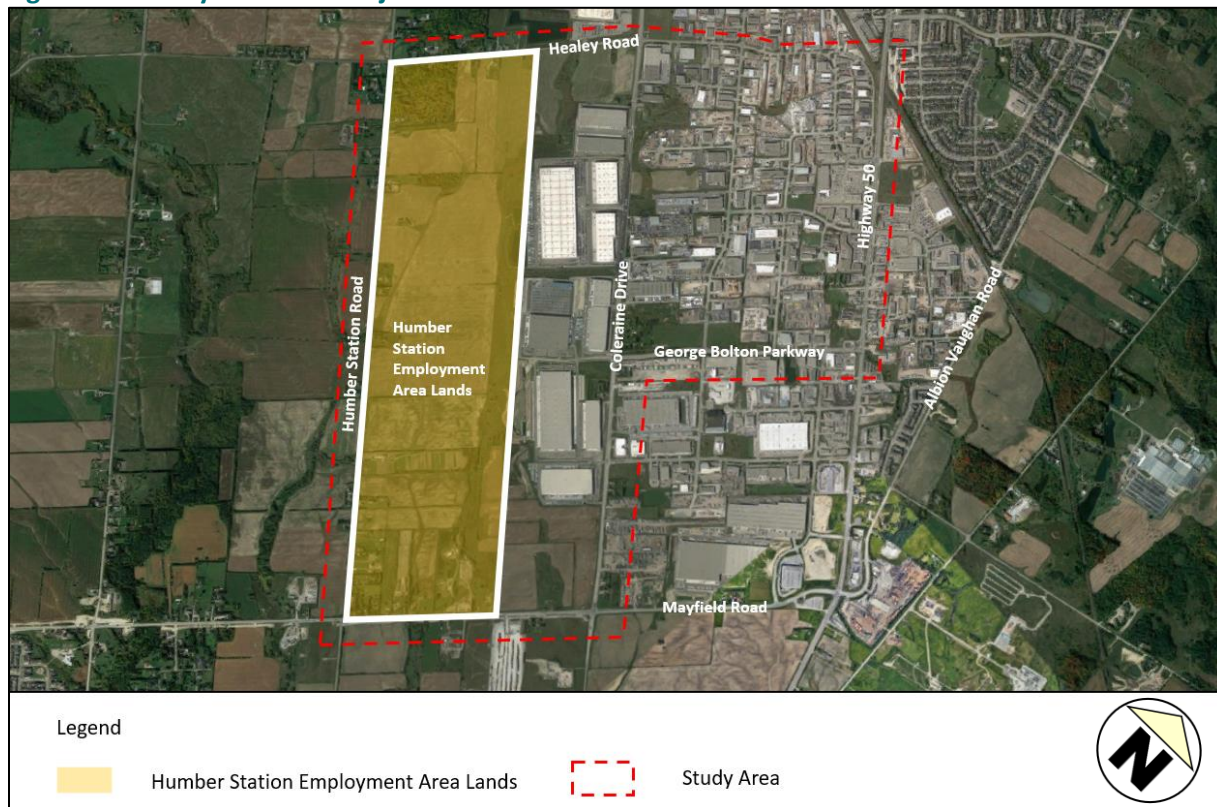

Source: Google Maps, accessed May 2023

The purpose of this study is to assess the proposed development of the Humber Station Employment Area lands from a transportation perspective, determine the traffic impacts on the adjacent road network, and identify any required mitigation measures. This Transportation Mobility Plan will assess a 5-, 10-, and 20-year horizon to the years 2028, 2033, and 2043, respectively. In addition, this study will outline Transportation Demand Management (TDM) measures to encourage alternative modes of travel. The study has been prepared in accordance with the Town of Caledon’s Transportation Impact Studies Terms of Reference and Guidelines dated March 2017.

1.2 HUMBER STATION EMPLOYMENT AREA LAND USE PLAN

The Humber Station Employment Area lands are planned for employment consisting of Prestige Employment and predominately General Employment land use designations. A portion of the subject lands has also been designated as Natural Features and Areas. The proposed land use plan for the Humber Station Employment Area lands is illustrated in **Figure 1-2** below.

Development of the Humber Station Employment Area lands will be realized in phases, with Parcel 1 (see **Figure 1-3**) being delivered first by the 2028 horizon year. Phase 2/full buildout of the site will occur by the 2033 horizon year. It is understood that access to the subject lands will be provided off the future George Bolton Parkway extension, as well as local connections to Humber Station Road, Healey Road, and Mayfield Road.

The subject lands are planned for a minimum density of 26 jobs per hectare to achieve the employment density target as outlined in the Town’s Draft Official Plan (August 2023). Based on the above-mentioned density target, 4,774 employees are anticipated upon full buildout of the subject lands. A breakdown of the proposed density by phase is summarized in **Table 1-1**.

Table 1-1: Proposed Density by Phase

Phase	Parcel	Land Use	Gross Area (ac)	Gross Area (ha)	Density Target (jobs/ha)	# Of Jobs/Employees
1	1	Industrial	95.0	38.0	26	988
2	2	Industrial	99.0	40.0	26	1,040
2	3-38 ⁽¹⁾	Industrial	261 ⁽²⁾	106 ⁽²⁾	26	2,746
Total	1 - 38	-	455	184	-	4,774

Note: (1) – The entirety of parcels 1-23 have been included in the calculation of total gross area. Only portions of parcels 24-38 have been included in this analysis due to the location of the future Highway 413 and its planned interchange at Humber Station Road and natural features area that would result in undevelopable land on the south portion of the site.

(2) Rounded up to the nearest whole number.

Figure 1-2: Proposed Land Use Plan

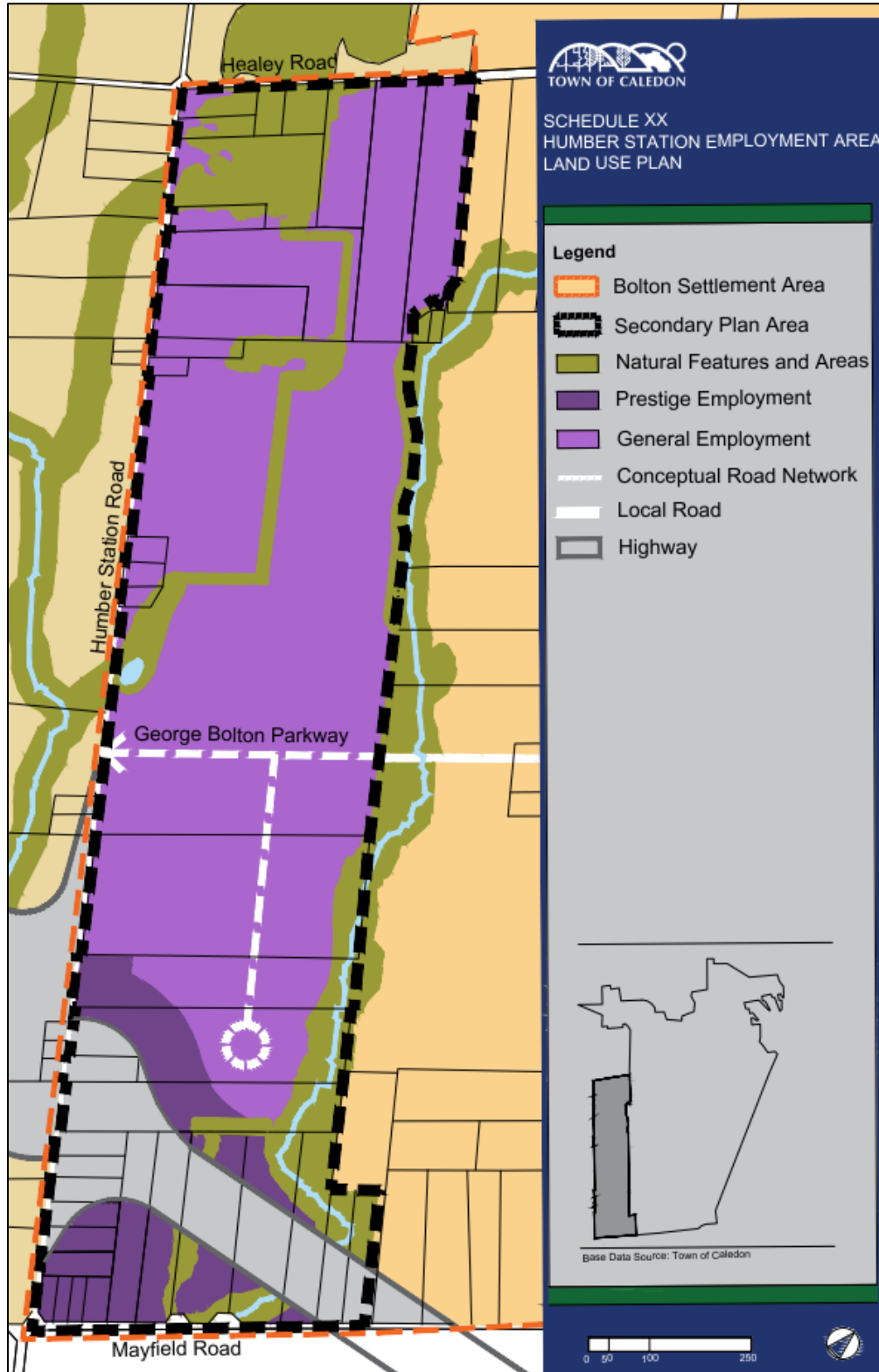

Source: SGL Planning, September 2023

Figure 1-3: Humber Station Employment Area Lands Parcel Mapping



Source: Adapted from Delta Urban, January 2023

2 POLICY CONTEXT & BACKGROUND STUDIES

The study area is guided by the regulatory framework of various policy documents, standards, and guidelines. This section summarizes the various provincial, regional, and local planning policies and guiding documents influencing the study area.

2.1 PROVINCIAL POLICY FRAMEWORK

Several provincial policy documents provide the basis and guidance for the transportation vision for the TMP study. Provincial plans are identified and summarized below.

2.1.1 Provincial Policy Statement (2020)

The Provincial Policy Statement (PPS) guides land use planning and development in Ontario. It contains a set of policies that outline a municipality's responsibility regarding transportation infrastructure and corridors to align with land use patterns and support multimodal travel for the efficient movement of people and goods. Section 1 of the PPS outlines the direction for building strong healthy communities and includes guidance in relation to managing effective land uses and implementation of infrastructure and public service facilities. Sections 1.6.7 and 1.6.8 provide policy direction on transportation systems and infrastructure corridors to ensure safe and energy-efficient networks to facilitate the movement of people and goods.

2.1.2 A Place to Grow - Growth Plan for the Greater Golden Horseshoe (2020)

A Place to Grow: Growth Plan for the Greater Golden Horseshoe (Growth Plan) guides decisions on a wide range of issues, such as land use, urban form, housing, environment, resource protection, transportation, and infrastructure, in the interest of economic prosperity. The Growth Plan provides population and employment growth forecasts for the Region that are required to be used for regional and local planning purposes. It also sets minimum intensification targets for delineated built-up areas and designated greenfield areas in the Region. The study area is located within the Greater Golden Horseshoe Growth Plan area. Key tenets of the Growth Plan include providing an integrated transportation network that is accessible and supports employment and a variety of housing.

2.1.3 Provincial Planning Statement (Proposed 2023)

The Ministry of Municipal Affairs and Housing (MMAH) is consulting on proposed policies for an integrated province-wide land use planning policy document that combines policies from The Growth Plan and the Provincial Policy Statement to support the achievement of the province's housing objectives. Should the Province adopt the proposed Provincial Planning Statement, the government would revoke the Provincial Policy Statement 2020 and amend regulations (O. Reg. 416/05 and O. Reg. 311/06) under the Places to Growth Act 2005.

The proposed Provincial Planning Statement will continue to outline the strategic vision for land use and development within Ontario. It represents the minimum standards that will guide planning authorities and decision-makers in developing and implementing specific plans, including transportation facilities to support the long-term prosperity and social well-being of Ontario. Transportation policies within the proposed Provincial Planning Statement focus on the safe and efficient movement of people and goods through a multi-modal transportation system and land use pattern that supports transit and active

transportation. Proposed policies also recognize that new developments should be compatible with existing or planned corridors and transportation facilities.

Furthermore, the proposed Provincial Planning Statement will guide decisions on a wide range of issues including land use, urban form, housing, environment, resource protection, transportation, and infrastructure in the interest of economic prosperity. The proposed statement addresses specific issues through policy direction, including designating lands within settlement areas located adjacent to major goods movement facilities and corridors (i.e., major highway interchanges) for manufacturing, warehousing, and employment activities.

2.1.4 Highway 413 Transportation Corridor Route Planning and Environmental Assessment Study

The Ministry of Transportation (MTO) initiated the Highway 413 Transportation Corridor Environmental Assessment (EA) (formerly GTA West Corridor) in 2007 to propose a new 400-series highway and transit corridor across the Halton, Peel, and York Region. The 52-kilometre proposed highway and transitway will extend from Highway 400 (between Kirby Road and King-Vaughan Road) in the east to Highway 401/407 ETR interchange area in the west. The project also includes a 3 km extension to Highway 427. The transitway would be a separate corridor running alongside the highway dedicated exclusively for public transit, such as buses or light rail transit.

A Terms of Reference was prepared for approval by the Ministry of the Environment (MOE) outlining the preliminary transportation problems and opportunities, existing environmental conditions, and the proposed alternatives to the undertaking. The need for Highway 413 was identified as a response to the overarching problem of the inter-regional transportation system as much of the higher-order road system (Highway 401, 400, 410, and 427) is expected to be heavily congested during peak periods and increasingly throughout the day. Furthermore, the lack of integration between local and inter-regional transit services beyond corridors served by GO Transit was identified as an issue that Highway 413 could address.

Following approval of the Terms of Reference, Stage 1 of the EA included a Transportation Development Strategy to determine recommendations for transit improvements, transportation demand management measures, and widening of provincial facilities in the western GTA. The Ontario government is currently in Stage 2 of the EA which was initiated in 2014. Stage 2 focuses on identifying the route and developing the preliminary design for the new multi-modal transportation corridor. Currently, the preferred route includes 11 interchanges along municipal roads. The subject lands are located within the Route Planning Study Area. As illustrated in **Figure 2-1**, an interchange is planned within the study area at Mayfield Road and Humber Station Road.

Figure 2-1: Highway 413 Technically Preferred Route and Interchange Locations

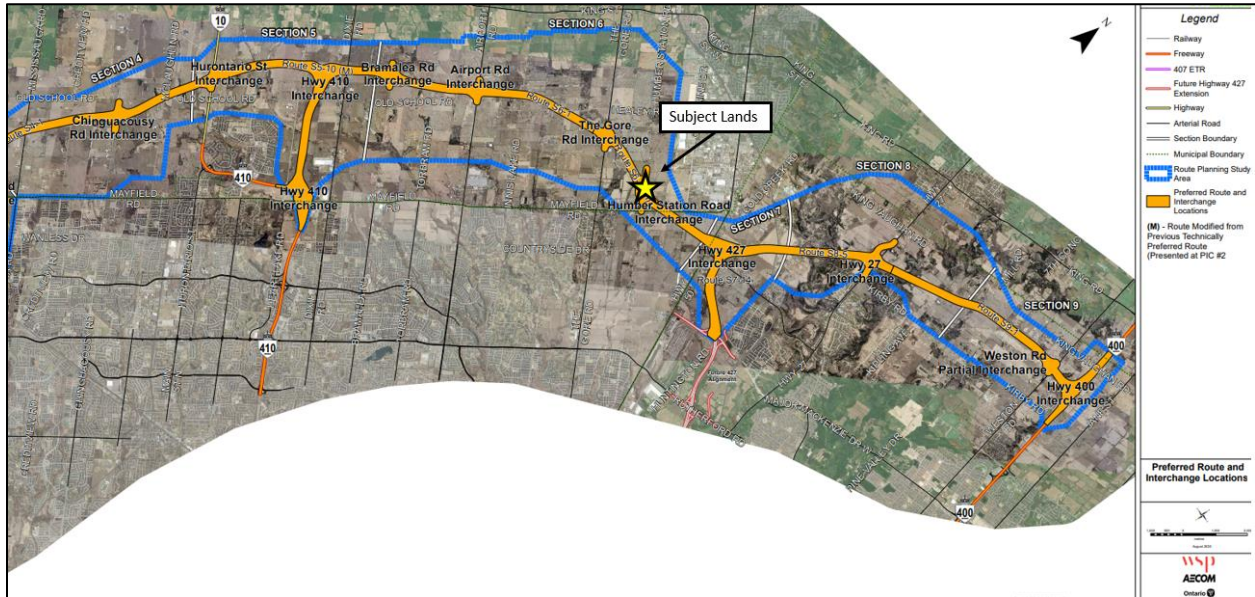

Source: Highway 413 project website (WSP, AECOM, Government of Ontario, August 2020)

2.2 REGIONAL POLICY FRAMEWORK

Several regional policy documents provide the basis and guidance for the transportation vision for the TMP study. Regional plans are identified and summarized below.

2.2.1 Region of Peel Official Plan (2022)

The Region of Peel Official Plan provides the long-term strategic policy framework for managing growth and development to create healthy, resilient, equitable, and sustainable regional communities for those living and working in Peel Region. The Regional Official Plan has an overarching theme of sustainable development to enable the integration of the environmental, social, economic, and cultural imperatives throughout the Plan.

Under the Regional Official Plan, the subject lands are included as part of the Pearson Airport Hub (Hwy 50 Corridor), a significant employment zone. From a transportation perspective, the Regional Official Plan includes policies to support goods movement by coordinating the major road network, the provincial freeway network, areas of significant employment activity, and major goods movement corridors. Furthermore, the Regional Official Plan includes policies to strengthen the regional network to accommodate current and projected travel demands of the people who live, work, or travel within the Region. Policies focus on creating a sustainable transportation system by encouraging the development of a safe, attractive, accessible, and integrated network for all travel modes.

2.2.2 Bolton Residential Expansion Study & Regional Official Plan Amendment (ROPA 30)

The Bolton Residential Expansion Study (BRES) was initiated to determine where the 2031 population assigned for Bolton by the Region of Peel would occur. The goals of the study were to evaluate and select an area for residential development, ensure the study fulfills the requirements of the Planning Act, and

provide an opportunity for public input. On November 30, 2020, the Region of Peel Council approved a Regional Official Plan Amendment for the Bolton Residential Area (ROPA 30).

ROPA 30 expands the Bolton Residential Expansion Area to include the subject lands (Option 6) and Triangle Lands as part of the Bolton Rural Service Centre. ROPA 30 has been prepared to provide a policy framework for the expansion while addressing a range of matters including infrastructure, financing, healthy development, transportation, natural heritage, and agricultural planning. The Bolton Residential Expansion Settlement Area will contribute to the development of the Bolton Rural Service Centre to be a complete community and provide a full range of transportation options including transit service, active transportation, and carpooling.

2.2.3 Peel Region Long Range Transportation Plan (2019)

Peel Region's Long Range Transportation Plan (LRTP) is a 5-year plan based on a 2041 horizon that guides transportation planning needs in the Region of Peel. The overarching goal of the LRTP is to establish a transportation network system where 50% of travel is through sustainable modes, such as walking, cycling, transit, and carpooling by 2041. The LRTP includes 3 focus areas including sustainable mobility, safe mobility, and vehicular mobility & goods movement to achieve a safer and more efficient road system.

To allow for growth, the LRTP prioritizes Region-wide strategies that focus on balancing intersection improvements and new infrastructure to facilitate transit, walking, and cycling with road widening and new road development. As illustrated in **Figure 2-2**, by the 2031 horizon year, Mayfield Road is proposed to widen to 6 lanes west of Humber Station Road and 4 lanes east of Humber Station Road while Coleraine Drive is recommended to widen to 4 lanes south of Mayfield Road to Highway 50. By the 2041 horizon year, Mayfield Road is proposed to widen to 6 lanes between Humber Station Road and Coleraine Drive. An additional 6-lane regional road connection (Arterial A2) is proposed south of the subject lands to connect Mayfield Road to Highway 50. Cycling infrastructure is also proposed along Mayfield Road, Coleraine Drive, and Highway 50.

Figure 2-2: Road Widening, Region of Peel 2031 and 2041 (LRTP)

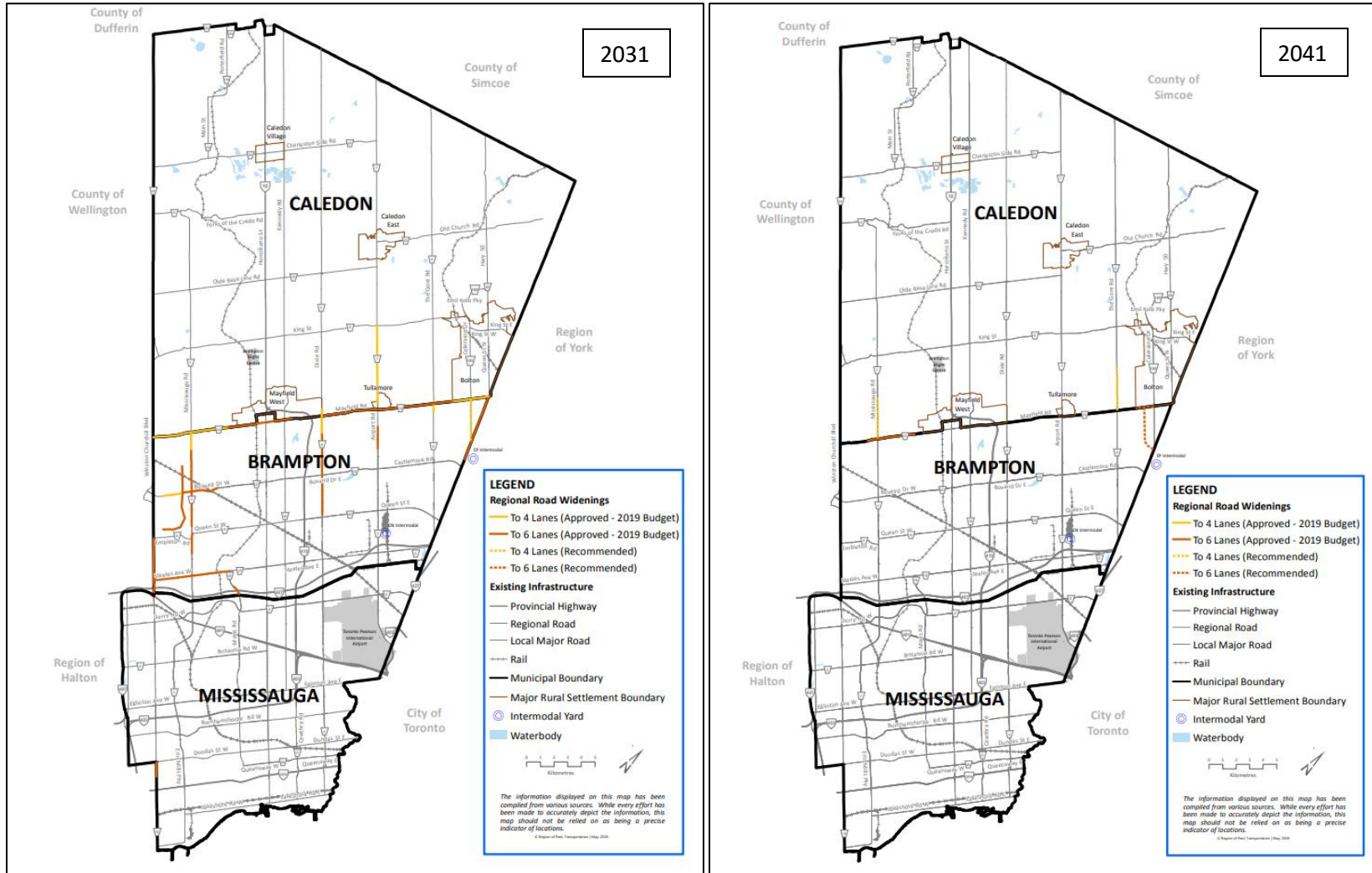

Source: Long Range Transportation Plan (Region of Peel, 2019)

2.3 LOCAL POLICY FRAMEWORK

Several local policy documents provide the basis and guidance for the transportation vision for the TMP study. Local plans are identified and summarized below.

2.3.1 Town of Caledon Official Plan (2018)

The Town of Caledon Official Plan sets out the policy framework for guiding future land use, physical development, and change within the Town. The broad transportation policies of the Official Plan include developing a safe, convenient, economical, efficient, sustainable, and energy-conserving transportation system for the movement of people and goods which will be well-integrated with the envisioned land use designations. Objectives include improved transportation mobility choices for residents, employees, and visitors to provide appropriate linkages between local, regional, and provincial roads, optimizing the use of existing and planned transportation infrastructure, and creating safe and efficient movement of goods and services within the Town. While the Official Plan recognizes that the primary mode of travel will be the automobile, transportation policies aim to create a comprehensive transportation system that accommodates all modes of travel.

2.3.2 Future Caledon: Official Plan (Draft 2023)

The draft Future Caledon Official Plan was prepared to conform with the 2020 Provincial Policy Statement, 2019 Growth Plan for the Greater Golden Horseshoe, and 2022 Region of Peel Official Plan. The new Official Plan will be implemented in 3 phases to replace the existing 2018 plan. The current draft provides the Phase 1 framework and policies to guide development and support population and employment growth to 2051.

The new Official Plan envisions a multimodal transportation system for the Town that is safe, efficient, manages future demand and congestion, and is well-integrated with the land use and development within the Town and across the Region. Based on *Schedule C1: Town-Wide Transportation Network* of the draft Official Plan, a conceptual collector road network of north-south and east-west connections is proposed throughout the subject lands. The feasibility of new collector roads will be conducted through secondary planning to facilitate development, connect future communities and employment lands, and accommodate continuity of transit service and active transportation routes while protecting the natural environmental features.

2.3.3 Caledon Transportation Master Plan (2017)

The Town of Caledon Transportation Master Plan (TMP) addresses the Town's transportation needs for the year 2031. The goals of the TMP include providing a transportation framework that will support economically sustainable and environmentally respectful growth and identifying opportunities for a multimodal transportation network while considering the needs of automobiles and safe and efficient goods movement.

The recommended transportation network identified in Caledon's TMP includes intersection and road improvements, plans for a Transit Implementation Strategy for future public transit service, and recommended active transportation facilities to connect Rural Service Centres to nearby communities, conservation areas, and scenic areas. Within the Humber Station Employment Area study area, the Humber Station Road & Healey Road intersection was identified to meet the traffic signal, left-turn lane, and right-turn lane warrants by the 2031 horizon year.

2.3.4 Caledon Multi-Modal Transportation Master Plan (On-going)

The Town of Caledon has initiated a Multi-Modal Transportation Master Plan (MMTMP) in coordination with the Caledon Official Plan to develop the long-term strategy for Caledon’s transportation system to accommodate the needs of pedestrians, cyclists, transit riders, and motorists while enhancing connectivity and accessibility. The MMTMP study is currently underway to recommend improvements for the road, active transportation, and transit networks. As a policy update, future collector roads would be assessed as part of the secondary or block plan process to connect to the Town’s collector and arterial road network.

The recommended MMTMP strategy includes the widening of Humber Station Road, Healey Road, and Mayfield Road as well as an extension of George Bolton Parkway from Coleraine Drive to Humber Station Road. The TMP strategy also recommends separated cycling facilities along Humber Station Road and Healey Road and proposes a local transit network throughout the study area.

2.3.5 Caledon Active Transportation Master Plan (On-going)

The Town of Caledon initiated its Active Transportation Master Plan (ATMP) in April 2022 to promote active transportation, trail development, and sustainable development. The ATMP builds on the Town’s Multi-Modal Transportation Master Plan to identify gaps in the existing active transportation network and to prioritize the implementation of a trail system, routes, and facilities to support a network of active transportation opportunities for people of all ages and abilities. Within the study area, active network expansion opportunities are identified along Humber Station Road and Healey Road.

2.3.6 Transportation Network Feasibility Study - Option 6 and Triangle Lands (2023)

The Transportation Network Feasibility Study (TNFS) was initiated by the Town of Caledon to recommend a potential collector road network for the Option 6 and Triangle Lands. The study aims to determine the technical feasibility of the proposed George Bolton Parkway extension crossing of the Clarkway Tributary, a potential extension of Peel Region Arterial A2 north of Mayfield Road, and other key network connections. The feasibility of the recommended conceptual road network would be determined through more detailed studies in the area such as Municipal Class Environmental Assessment(s). The recommended road network identified in the TNFS is illustrated in **Figure 2-3** and includes the following:

- **TNFS Recommended Network (Option 3):** A new two-lane east-west corridor extending George Bolton Parkway westerly to Humber Station Road + a new two-lane north-south corridor extending Arterial A2 northerly to the new George Bolton Parkway extension. To support additional east-west connectivity, it is also recommended that a signalized intersection at Coleraine Drive be implemented, located approximately midblock between Parr Boulevard and Mayfield Road.

Figure 2-3: Transportation Network Feasibility Study Recommended Road Network (Option 3)

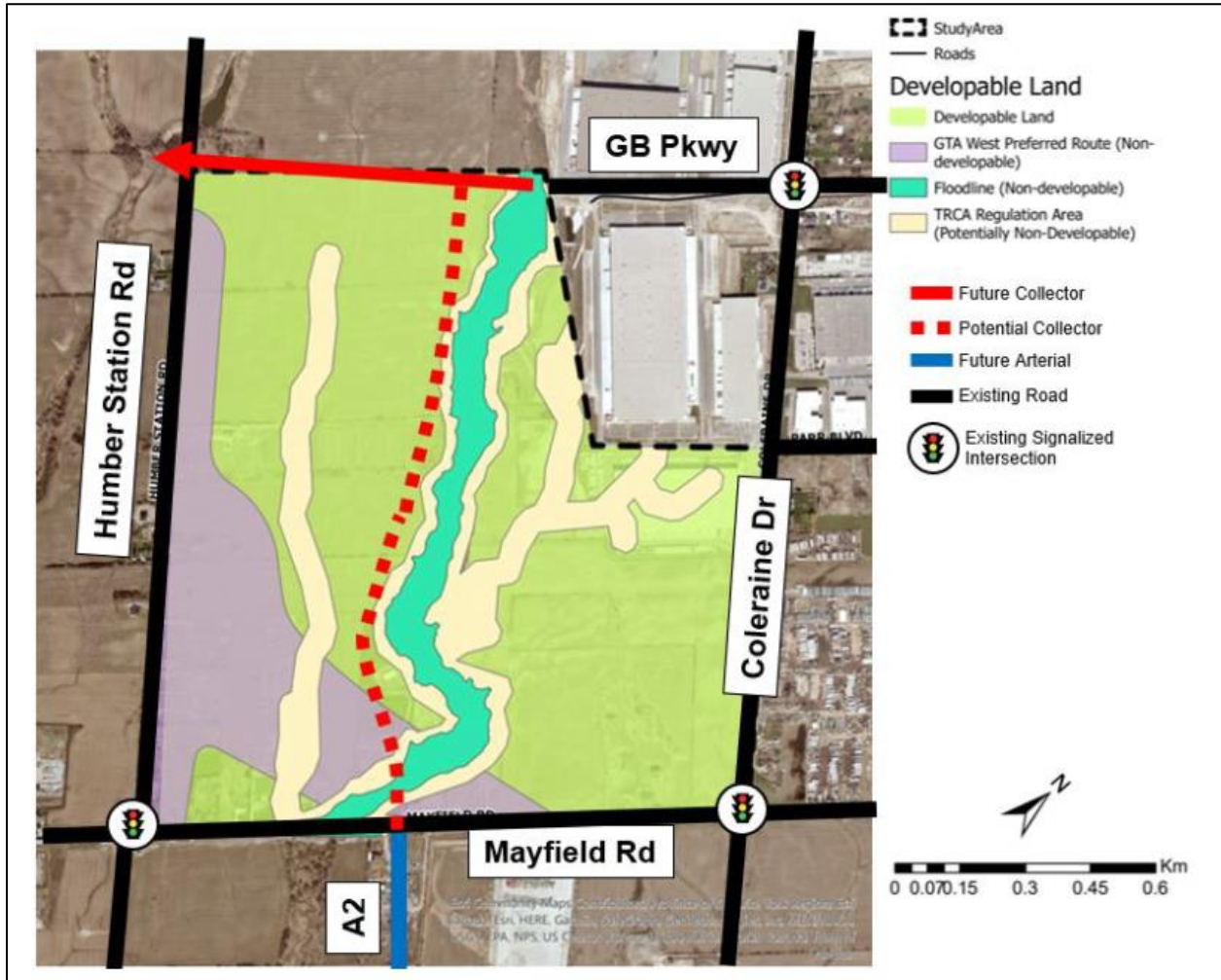

Source: Transportation Network Feasibility Study - Option 6 and Triangle Lands (June 2023)

2.4 MUNICIPAL CLASS ENVIRONMENTAL ASSESSMENT

2.4.1 Highway 427 Industrial Secondary Plan Area (Area 47)

The Region of Peel and the City of Brampton undertook two Schedule 'C' Municipal Class Environmental Assessments (Class EA) Phases 3 & 4 study for the arterial roads within the Highway 427 Industrial Secondary Plan Area (Area 47), located south of the subject lands. The purpose of the study was to consider a range of transportation improvements to satisfy future capacity needs. The preferred design identified in the Highway 427 Industrial Secondary Plan Area Class EA includes the following:

- Arterial A2: a new 6-lane north-south roadway that connects Major Mackenzie Drive to Mayfield Road
- Coleraine Drive: an existing roadway that will be widened to 4 lanes and upgraded to include curb and gutter and multi-use pathways (MUP)
- Countryside Drive: an existing roadway which will be widened to 4 lanes and upgraded to include curb and gutter and MUP

- Clarkway Drive: an existing roadway that will have portions widening to 4 lanes and upgraded to include storm sewers, sidewalks, and cycle lanes
- East-West Arterial: a new 4-lane roadway connecting the Gore Road to Arterial A2.

The proposed roadways within the Highway 427 Industrial Secondary Plan Area are illustrated in **Figure 2-4**.

Figure 2-4: Proposed Roadways within Highway 427 Industrial Secondary Plan Area (Area 47)

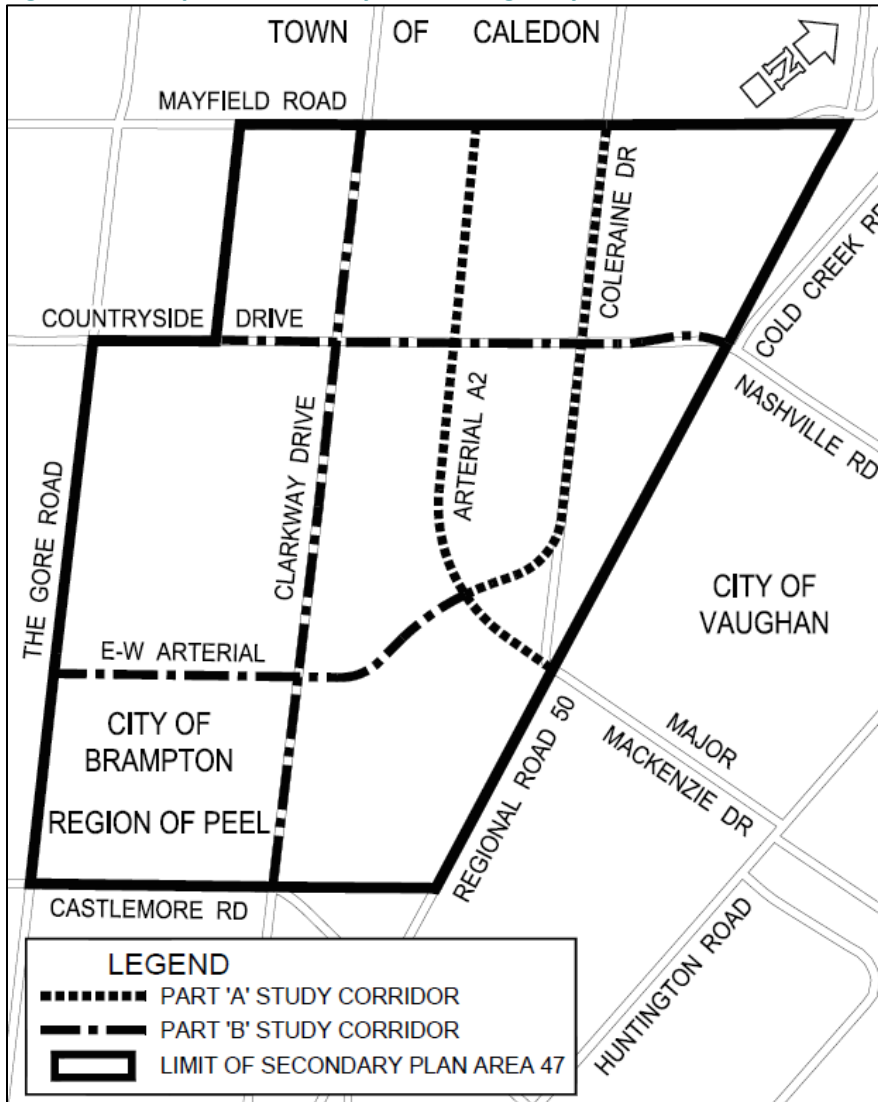

Source: Region of Peel

3 EXISTING TRANSPORTATION CONDITIONS

This section identifies and assesses the existing transportation conditions within the study area as it relates to the road, transit, cycling, and pedestrian networks. An overview of the existing transportation conditions is provided to identify the transportation deficiencies and potential opportunities for solutions to serve existing and future demand for the study area. This study includes the analysis of the following roads and intersections:

- ▶ Humber Station Road/Clarkway Drive & Mayfield Road (signalized);
- ▶ Humber Station Road & Healey Road (unsignalized);
- ▶ Coleraine Drive & Healey Road (signalized);
- ▶ Coleraine Drive & George Bolton Parkway (signalized);
- ▶ Coleraine Drive & Mayfield Road(signalized); and
- ▶ Highway 50 & George Bolton Parkway (signalized).

3.1 EXISTING ROAD NETWORK

The Humber Station Employment Area study area is currently serviced by an existing network of Peel Region and Town of Caledon roadways, with the exception of Clarkway Drive which is under the jurisdiction of the City of Brampton.

Within the overall study area, there are 3 regional roadways: Highway 50 and Mayfield Road are classified as high-capacity arterials while Coleraine Drive is classified as a medium-capacity arterial. The study area also includes 4 main municipal roadways: Humber Station Road, Clarkway Drive, and Healey Road are classified as collectors while George Bolton Parkway is classified as an industrial collector. The remaining roadways are local streets and property accesses.

The following section provides a description of the roadways within the study area. **Figure 3-1** illustrates the existing intersections and lane configuration.

Figure 3-1: Existing Road Network and Lane Configuration

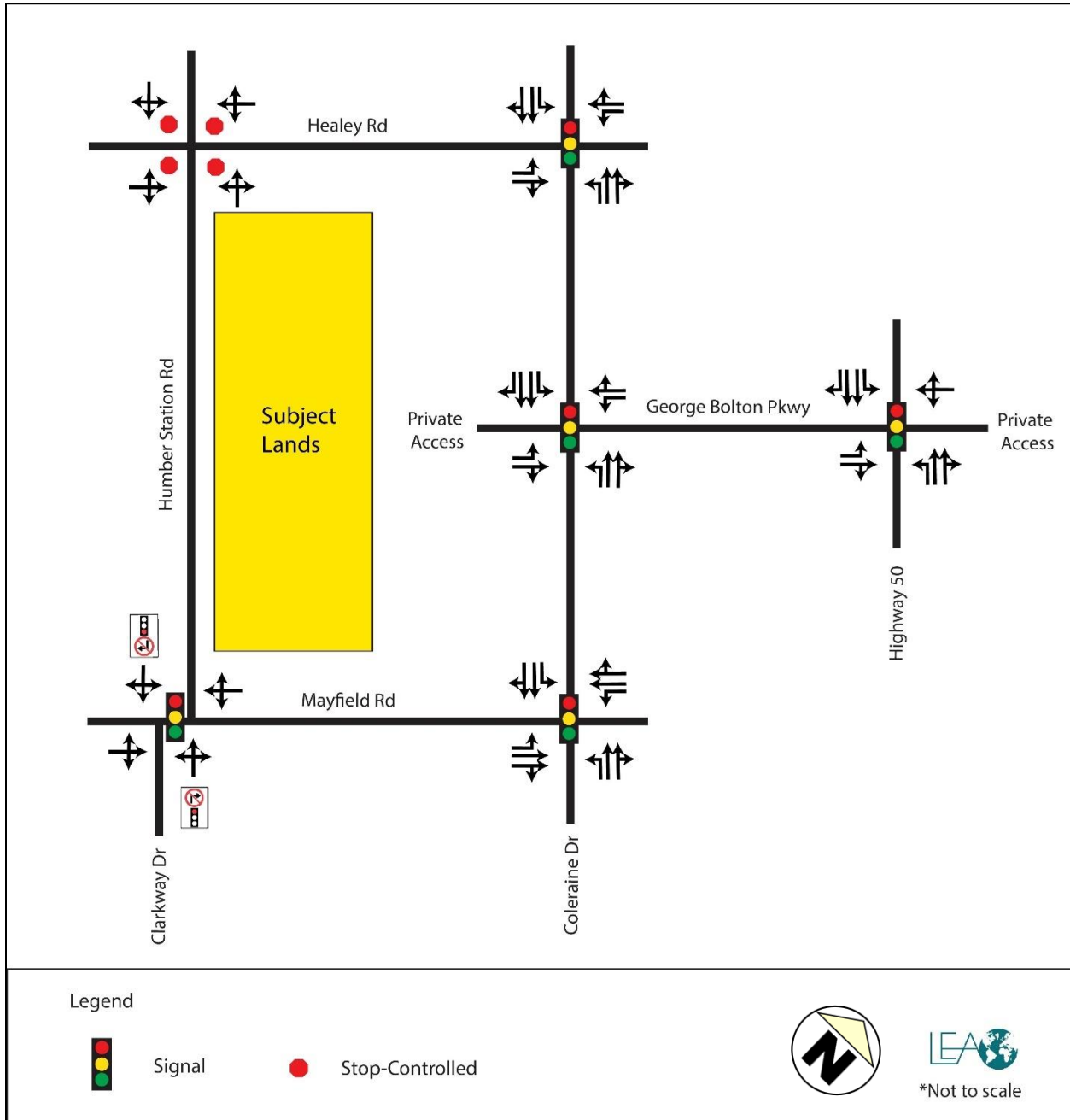

- **Humber Station Road** is a north-south collector road under the jurisdiction of the Town of Caledon. The roadway extends north from Mayfield Road to Highway 9, operating with a 2-lane cross-section (1 lane per direction) and with a posted speed limit of 80 km/h within the study area.
- **Coleraine Drive** is a north-south medium-capacity arterial road under the jurisdiction of Peel Region. The roadway extends north from Highway 50 to King Street W before continuing as Emil Kolb Parkway. Coleraine Drive operates with a 4-lane cross-section (2 lanes per direction) and with a posted speed limit of 70 km/h within the study area.

- **Highway 50** is a north-south high-capacity arterial road under the jurisdiction of Peel Region. The roadway extends north from Steeles Avenue W in Brampton to ON-89 in Alliston, operating with a 4-lane cross-section (2 lanes per direction) and with a posted speed limit of 60 km/h within the study area.
- **Clarkway Drive** is a north-south collector road under the jurisdiction of the City of Brampton. The roadway extends north from Cottrelle Boulevard in Brampton to Mayfield Road, operating with a 2-lane cross-section (1 lane per direction) and with a posted speed limit of 70 km/h within the study area.
- **Mayfield Road** is an east-west high-capacity arterial road under the jurisdiction of Peel Region. The roadway extends west from Albion Vaughan Road to Winston Churchill Boulevard in Halton Hills. The roadway acts as a municipal boundary between Caledon and Brampton. Mayfield Road operates with a 2-lane cross-section (1 lane per direction) and with a posted speed limit of 80 km/h within the study area.
- **Healey Road** is an east-west collector road under the jurisdiction of the Town of Caledon. The roadway extends west from Queen Street S to Airport Road, operating with a 2-lane cross-section (1 lane per direction) and with a posted speed limit of 60 km/h within the study area.
- **George Bolton Parkway** is an east-west industrial collector road under the jurisdiction of the Town of Caledon. The roadway extends west from Highway 50 and terminates approximately 430 m west of Coleraine Drive. George Bolton Parkway operates with a 2-lane cross-section (1 lane per direction) and with a posted speed limit of 50 km/h within the study area.

3.2 EXISTING TRANSIT NETWORK

There is currently no Town-wide local public transit service operated by the Town of Caledon. However, following the Town’s Transit Feasibility Study in 2019, Voyago was retained to provide local service in the Bolton area. The local transit line includes 39 bus stops between the area of Highway 50 & Highway 7 and Highway 50 & Columbia Way. The route operates Monday to Friday during peak commute hours.

An inter-regional commuter bus service is also available within the Bolton area. The inter-regional route is operated by GO Transit between Malton and the area of Highway 50 & Columbia Way with opportunities to transfer to Metrolinx’s GO rail transit. The route operates Monday to Friday during peak hours. The existing transit routes within the Bolton area are illustrated in **Figure 3-2** and **Figure 3-3**. Details of the available services in the area are provided in **Table 3-1**.

Table 3-1: Existing Transit Service

Transit System	Route	Description	Frequency	Accessibility from Subject Site
GO Transit	Route 38	Bolton to Malton (Monday to Friday, 5AM - 7:30AM and 3:30PM - 6:30PM)	60 minutes	Mayfield Road @ Highway 50: 2km
Voyago	Local Route	Bolton to Brampton (Monday to Friday, 6AM - 9:30AM and 3PM - 6:30 PM)	30 minutes	George Bolton Parkway @ Coleraine Drive: 450m

Figure 3-2: GO Transit Route 38



Source: GO Train and Bus Schedule (Metrolinx, April 2023)

Figure 3-3: Bolton Local Transit Route

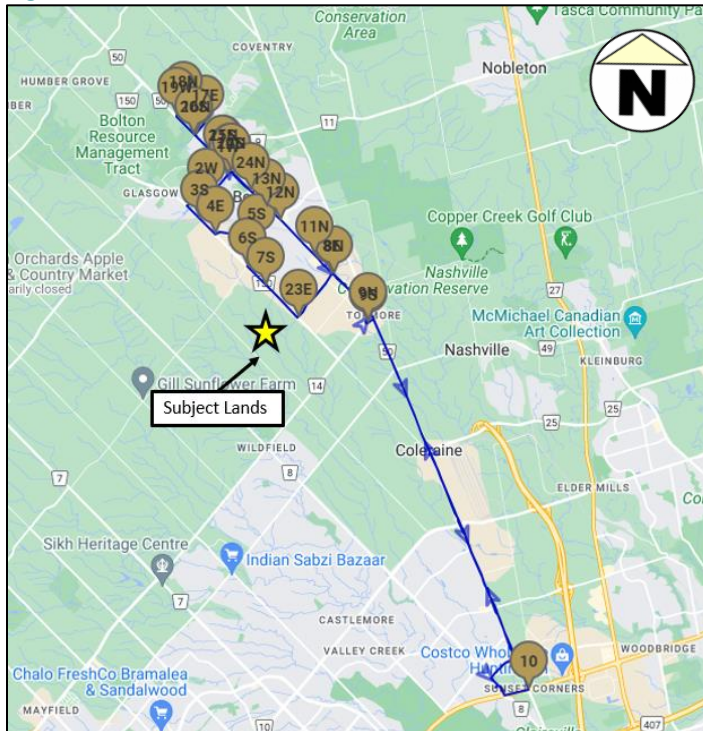

Source: Buswhere (2023)

3.3 EXISTING CYCLING NETWORK

Cycling facilities in Caledon consist of on and off-road facilities that are managed by the Town of Caledon, Peel Region, and adjacent municipalities. Due to the current rural and undeveloped nature of the study area, there are a limited number of active transportation and cycling facilities. Bike lanes are provided on both sides of George Bolton Parkway, east of Coleraine Drive as well along a portion of McEwan Drive W within the Coleraine West Employment Lands. However, no cycling facilities are available along the remaining study area roadways. **Figure 3-4** illustrates the existing and planned cycling facilities within the study area.

Figure 3-4: Existing and Planned Cycling Network

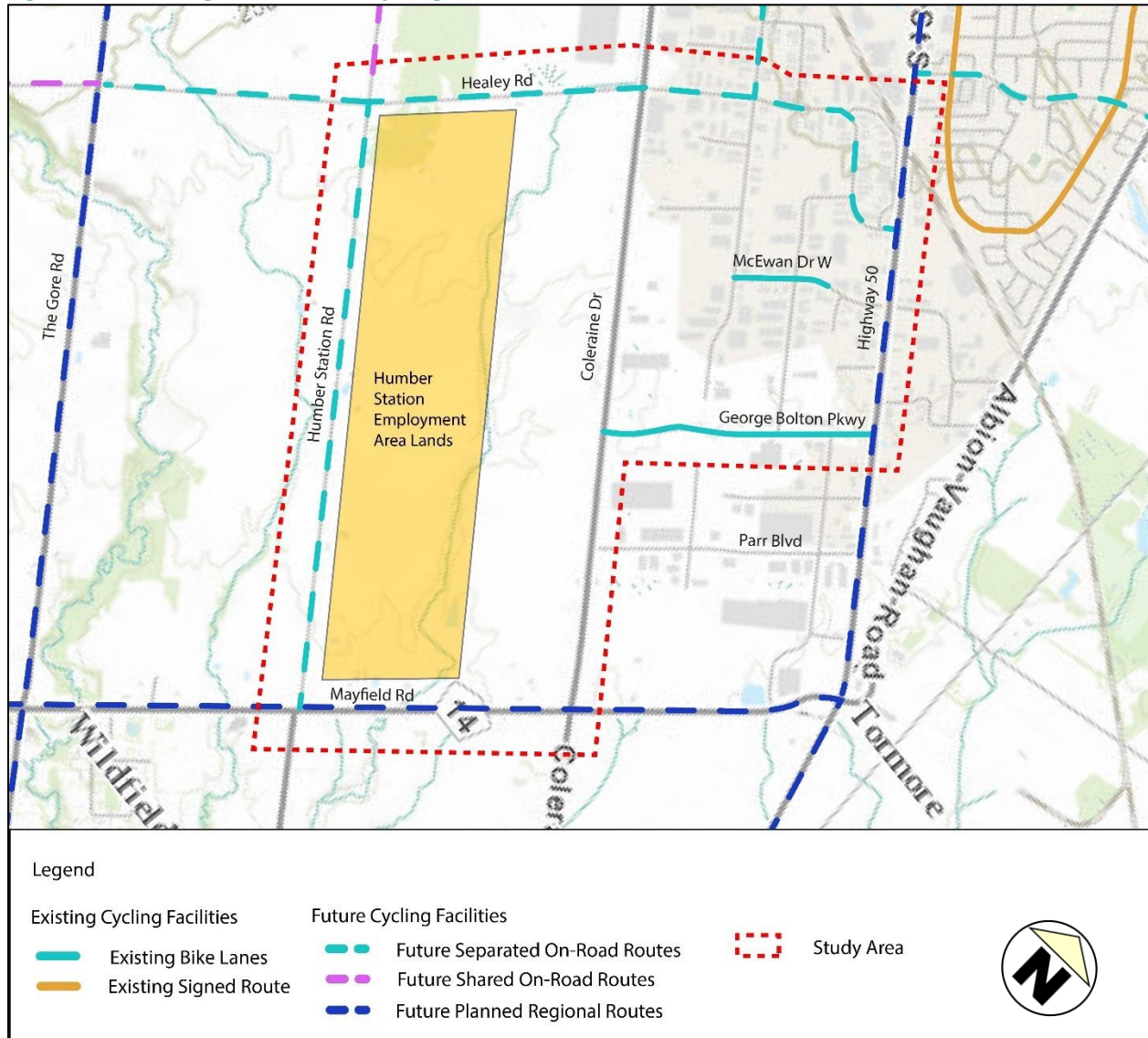

3.3.1.1 Cycling Multimodal Level of Service Evaluation

An analysis of the multimodal level of service (MMLOS) for the cycling network in the study area was undertaken to provide a baseline biking level of service in the study area. The cycling network has been

evaluated in accordance with the *City of Ottawa’s Multi-Modal Level of Service (MMLOS) Guidelines* to describe the convenience and comfort level of active transportation infrastructure in the study area. The results are on a scale of ‘A’ to ‘F’, where ‘A’ represents the preferred conditions and ‘F’ represents the least preferred conditions. The biking level of service (BLOS) evaluation was conducted for the worst segments of Healey Road, Humber Station Road, Mayfield Road, Coleraine Drive, and George Bolton Parkway within the study area.

The BLOS for the study area roadway segments is summarized in **Table 3-2**. Detailed MMLOS analysis is provided in **Appendix A**.

Table 3-2: Existing Bicycle Level of Service (BLOS)

Segment	From	To	Side	Existing (2023)
				LOS
Healey Road	Humber Station Road	Coleraine Drive	North	F
			South	F
Humber Station Road	Healey Road	Mayfield Road	East	F
			West	F
Mayfield Road	Humber Station Road	Coleraine Drive	North	F
			South	F
Coleraine Drive	Mayfield Road	George Bolton Parkway	East	F
			West	F
Coleraine Drive	George Bolton Parkway	Healey Road	East	F
			West	F
George Bolton Parkway	Coleraine Drive	Highway 50	North	B
			South	B

Overall, the study area displays a BLOS of ‘B’ to ‘F’. This is largely due to the lack of dedicated cycling facilities, the number of travel lanes, and the speed of traffic along most roads within the study area. The highest BLOS occurs along George Bolton Parkway between Coleraine Drive and Highway 50, where a bike lane is provided.

3.4 EXISTING PEDESTRIAN NETWORK

Given the rural nature of the Humber Station Employment Lands, the site exhibits poor pedestrian connectivity, a lack of collector/local streets, missing facilities, and discontinuous sidewalks. Majority of the pedestrian facilities are concentrated within the residential community located northeast of the study area. Within the study area, sidewalks are provided along one side of Parr Boulevard, Simona Drive, George Bolton Parkway, Pillsworth Road, Simpson Road, and segments of Highway 50. A multi-use path is also provided along George Bolton Parkway. Sidewalks are missing along the surrounding collector and arterial roadway including Mayfield Road, Coleraine Drive, Humber Station Road, and Healey Road. Sidewalks are also missing along a majority of the local streets within the Coleraine West Employment Lands.

As illustrated in **Figure 3-5**, pedestrian facilities are provided connecting the employment lands with existing local transit stops located at George Bolton Parkway & Coleraine Drive and George Bolton Parkway & Highway 50.

Figure 3-5: Existing Pedestrian Network

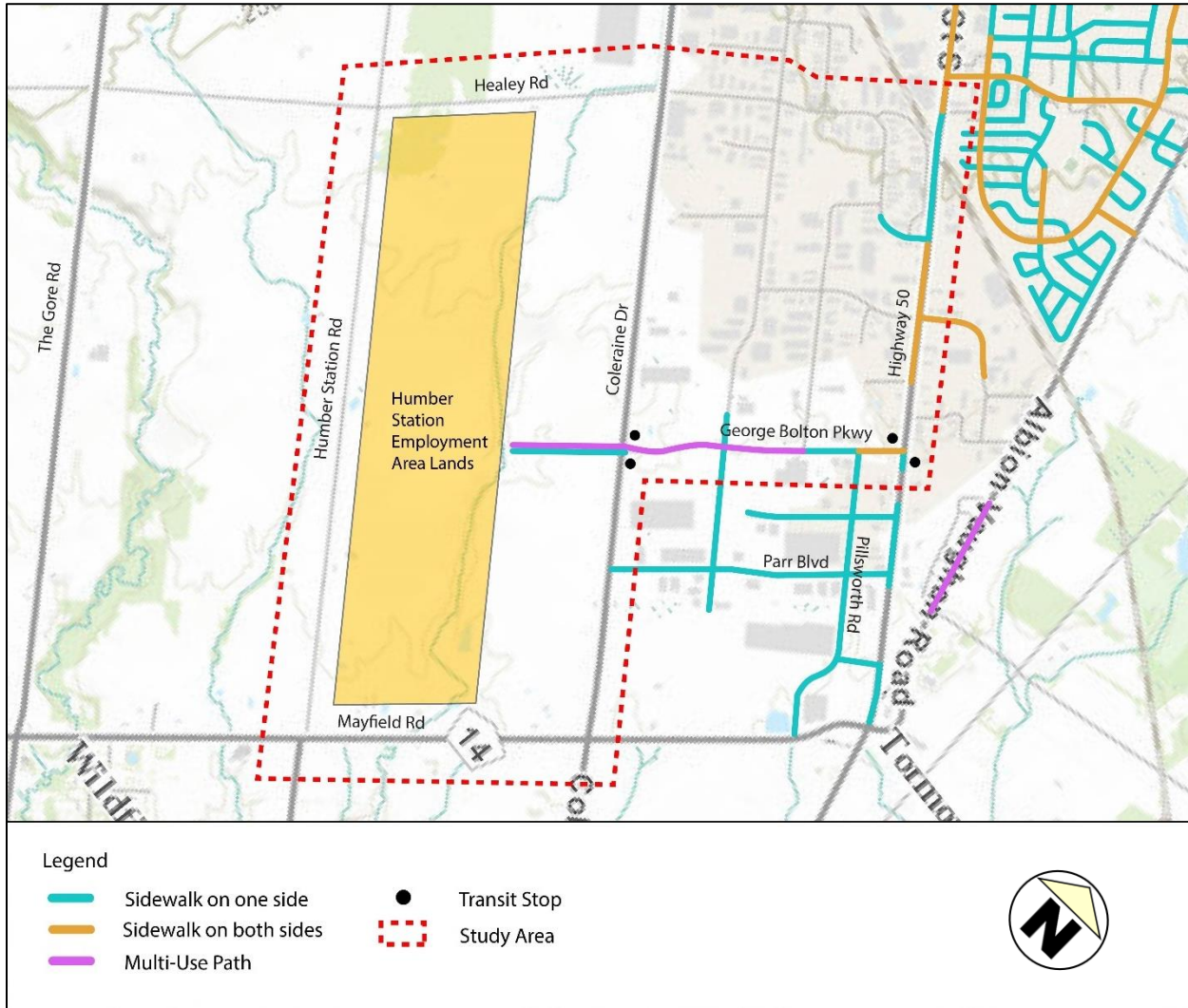

3.4.1.1 Pedestrian Multimodal Level of Service Evaluation

An analysis of the multimodal level of service (MMLOS) for the pedestrian network in the study area was undertaken to provide a baseline pedestrian level of service in the study area. The pedestrian network has been evaluated in accordance with the *City of Ottawa’s Multi-Modal Level of Service (MMLOS) Guidelines* to describe the convenience and comfort level of active transportation infrastructure in the study area. The results are on a scale of ‘A’ to ‘F’, where ‘A’ represents the preferred conditions and ‘F’ represents the least preferred conditions. The pedestrian level of service (PLOS) evaluation was conducted for the worst segments of Healey Road, Humber Station Road, Mayfield Road, Coleraine Drive, and George Bolton Parkway within the study area.

The PLOS for the study area roadway segments is summarized in **Table 3-3**. Detailed MMLOS analysis is provided in **Appendix A**.

Table 3-3: Existing Pedestrian Level of Service (PLOS)

Segment	From	To	Side	Existing (2023)
				LOS
Healey Road	Humber Station Road	Coleraine Drive	North	F
			South	F
Humber Station Road	Healey Road	Mayfield Road	East	F
			West	F
Mayfield Road	Humber Station Road	Coleraine Drive	North	F
			South	F
Coleraine Drive	Mayfield Road	George Bolton Parkway	East	F
			West	F
Coleraine Drive	George Bolton Parkway	Healey Road	East	F
			West	F
George Bolton Parkway	Coleraine Drive	Highway 50	North	C
			South	F

Overall, the study area displays a PLOS of 'C' to 'F'. This is largely due to the lack of pedestrian facilities along the arterial and collector roads within the study area including Mayfield Road, Coleraine Drive, Humber Station Road, and Healey Road. Pedestrian facilities are provided along the south side of George Bolton Parkway; however, sidewalks are less than 1.5 m wide and have no separation from high-speed vehicles resulting in a PLOS of 'F' for this segment.

3.5 TRAFFIC DATA COLLECTION

Turning movement counts (TMCs) were used as the source of traffic data for the intersection capacity analysis. Traffic counts were collected by LEA Consulting on Wednesday, May 3, 2023, between 7:00 AM - 9:30 AM and 4:00 PM - 6:30 PM to capture the weekday AM and PM peak periods. To note, during the time of the survey, the south approach at Coleraine Drive & Mayfield Road was closed for construction. As such, traffic counts were obtained from the Region of Peel and balanced with adjacent intersections.

Signal timing plans at the signalized intersections were obtained from the Region of Peel. Heavy vehicle traffic, pedestrian traffic, and cyclist traffic were recorded separately and included in the capacity analysis. A summary of the TMC data collected is provided in **Table 3-4**, with detailed traffic counts and signal timing plans available in **Appendix B**.

Table 3-4: Data Collection Summary

Intersection	TMC Date	Source
Coleraine Drive & Healey Road	Wednesday, May 3, 2023	LEA Consulting
Humber Station Road & Healey Road		
Mayfield Road & Humber Station Road/Clarkway Drive		
Coleraine Drive & George Bolton Parkway/Private Access		
Highway 50 & George Bolton Parkway/Private Access		
Mayfield Road & Coleraine Drive	Tuesday, May 7, 2013	MG8 ENG

As of fall 2022, it is understood that the Town of Caledon accepts new traffic data. As such, no COVID adjustments were performed on the counts collected.

3.6 EXISTING SYNCHRO MODEL INPUTS

Existing traffic operations were assessed to provide a baseline for future traffic operations and identify intersections currently experiencing capacity constraints. The existing analysis incorporates the most recent signal timing plans for the study intersections. The applied Peak Hour Factor (PHF) values were calculated based on surveyed counts.

3.7 EXISTING TRAFFIC VOLUMES

The existing traffic volumes during the weekday AM and PM peak hours are illustrated in **Figure 3-6**. Volume balancing was applied to through movements where adjacent intersections had volume discrepancies greater than 10%.

Figure 3-6: Existing Peak Hour Traffic Volumes

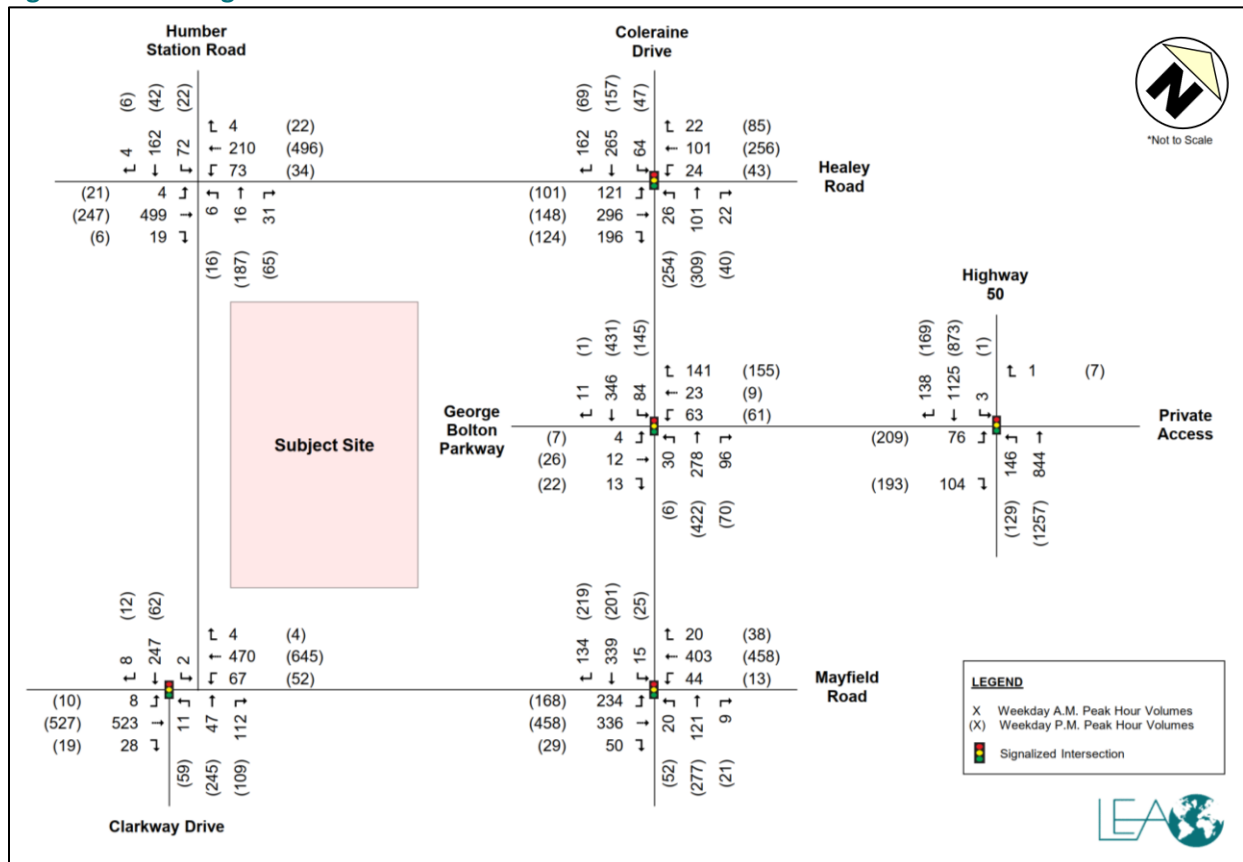

4 FUTURE BACKGROUND TRANSPORTATION CONDITIONS

For the analysis of future background traffic conditions, this study considers a 5-, 10-, and 20-year horizon from the existing year 2023 to the future years 2028, 2033, and 2043, respectively. Future background conditions include traffic added to the network from other future developments, corridor growth, and road network improvements. The future background conditions will be used as the baseline for evaluating the impact of the proposed development.

4.1 BACKGROUND DEVELOPMENTS

4 background developments have been identified within the surrounding study area. Detailed information on the background developments included in the analysis was obtained from the Town’s development application online inventory. The background developments are summarized in **Table 4-1** with their location illustrated in **Figure 4-1**.

Table 4-1: Background Developments

#	Development	Statistics	Anticipated Horizon	Source
1	12544 Highway 50	Gas Station 279 m ² of retail GFA 461 m ² of retail GFA	2028	TIS dated March 2017 (Figure 5-1) LMM Engineering Inc.
2	Triangle Lands	406,000 m ² of industrial GFA	2028	LEA Estimate
3	Coleraine Drive & Mayfield Road Block Plan (South Simpson Landowners Group)	224,000 m ² of industrial GFA	2028	LEA Estimate
4	12563 & 12599 Highway 50 – Phase 1	1,301 residential units 2,399 m ² of retail GFA	2033	TIS dated January 2022 (Figure 21) BA Group
	12563 & 12599 Highway 50 – Full Buildout	2,238 residential units 3,179 m ² of retail GFA	2043	TIS dated January 2022 (Figure 24) BA Group

The background development traffic volumes were extracted from their respective traffic studies for their development applications and subsequently assigned to the study area road network. Excerpts from the studies are provided in **Appendix C**. As traffic studies were not available for background development #2 and #3, site traffic was estimated based on ITE Trip Generation rates and TTS trip distribution, and subsequently assigned to the study area. It was assumed that site accesses for the Triangle Lands and Coleraine Drive & Mayfield Road Block Plan development would occur along Mayfield Road. Detailed background development site traffic volumes and calculations are provided in **Appendix C**.

Figure 4-1: Background Development Locations



4.2 CORRIDOR GROWTH

EMME plots from the Region of Peel’s 2021, 2031, and 2041 Travel Demand Forecasting Model were used to determine corridor growth rates along major roads. **Table 4-2** summarizes the applied growth rates calculated between screenlines. Detailed corridor growth rate calculations are provided in **Appendix D**.

Table 4-2: Corridor Growth Summary

Corridor	Direction	Annual Growth Rate (AM/PM)
Humber Station Road	Northbound	2%
	Southbound	1%
Mayfield Road	Eastbound	3%
	Westbound	2%
Healey Road	Eastbound	3%
	Westbound	4%
Coleraine Drive	Northbound	2%
	Southbound	0%
Highway 50	Northbound	1%
	Southbound	0%

4.3 PLANNED EXTERNAL ROAD NETWORK

As identified in **Section 2**, there are several proposed and planned changes to the road network surrounding the subject lands. The road network improvements considered in the future horizons are summarized in **Table 4-3**. To note, based on correspondence with Regional staff (see **Appendix E**), it is understood that the widening of Mayfield Road from 2 to 6 lanes west of Humber Station Road and from 2 to 4 lanes between Humber Station Road and Highway 50 is scheduled for construction starting 2026. As such, the completion of this improvement has been considered by the 2028 horizon year.

Furthermore, based on the Town’s Draft TMP anticipated timing of 2051 for the widening of Humber Station Road and Healey Road, and given limited information on the Arterial A2 north extension, these improvements were not considered in the analysis of future background conditions.

Table 4-3: Future Transportation Network Improvements

Roadway	Network Improvement	Horizon Year as per Policy Document	Included in Analysis?
Provincial			
Highway 413	Highway 413 Transportation Corridor Route Planning Study <ul style="list-style-type: none"> New 400-series highway with an interchange at Humber Station Road, north of Mayfield Road 	2041	Yes
Regional			
Coleraine Drive	Peel Region Long Range Transportation Plan <ul style="list-style-type: none"> Widening from 2 to 4 lanes, between Mayfield Road and Highway 50 	2031	Yes
Mayfield Road	Peel Region Long Range Transportation Plan <ul style="list-style-type: none"> Widening from 2 to 6 lanes, between Dixie Road and Humber Station Road Widening from 2 to 4 lanes, between Humber Station Road and Highway 50 	2031	Yes ⁽¹⁾
	Peel Region Long Range Transportation Plan <ul style="list-style-type: none"> Widening from 4 to 6 lanes, between Humber Station Road and Coleraine Drive 	2041	Yes
Arterial A2	Peel Region Long Range Transportation Plan <ul style="list-style-type: none"> New 6-lane road connection located between Humber Station Road and Coleraine Drive, extending from Mayfield Road to Highway 50 	2041	Yes
Arterial A2 North Extension	Transportation Network Feasibility Study <ul style="list-style-type: none"> New 2-lane extension of Arterial A2 between Mayfield Road and George Bolton Parkway extension 	-	No
Local			
Humber Station Road	Town of Caledon Transportation Master Plan <ul style="list-style-type: none"> Proposed signalization of Humber Station Road & Healey Road 	2031	Yes ⁽²⁾
	Draft Town of Caledon Transportation Master Plan <ul style="list-style-type: none"> Widening from 2 to 4 lanes, between Highway 8 and Mayfield Road 	2051	No

Roadway	Network Improvement	Horizon Year as per Policy Document	Included in Analysis?
Healey Road	Town of Caledon Transportation Master Plan <ul style="list-style-type: none"> Proposed signalization of Humber Station Road & Healey Road 	2031	Yes ⁽²⁾
	Draft Town of Caledon Transportation Master Plan <ul style="list-style-type: none"> Widening from 2 to 4 lanes, between Heritage Road and Coleraine Drive 	2051	No
George Bolton Parkway	Draft Town of Caledon Transportation Master Plan <ul style="list-style-type: none"> Extension between Coleraine Drive and Humber Station Road 	-	To be built out by the development proposal

Note: (1) – The widening of Mayfield Road from 2 to 6 lanes west of Humber Station Road and from 2 to 4 lanes between Humber Station Road and Highway 50 has been considered under the 2028 horizon year based on correspondence with the Region.

(2) – Based on the capacity analysis results in **Section 7**, the signalization of Humber Station Road & Healey Road is recommended by the 2028 horizon year.

Figure 4-2 illustrates the ultimate 2043 future background road network. To note, planned infrastructure improvements could be advanced to further the development of the ultimate road network.

Figure 4-2: 2043 Future Background Road Network

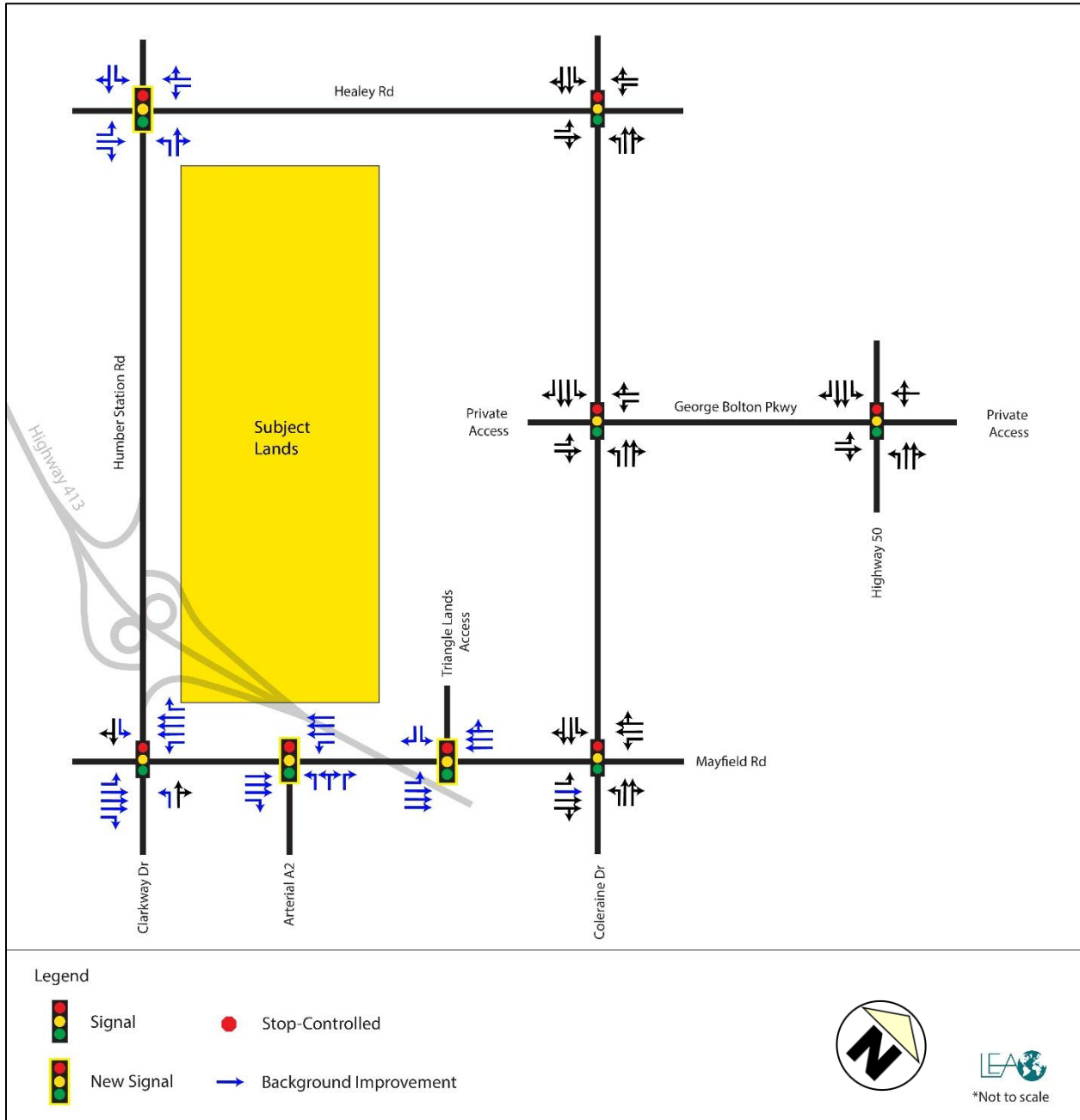

Note: Lane configuration and traffic control for new intersections were based on required improvements from the intersection capacity analysis results in Section 7.

4.4 PLANNED TRANSIT AND ACTIVE TRANSPORTATION IMPROVEMENTS

As illustrated in **Figure 4-3**, the Town of Caledon’s draft MMTMP proposes a future transit network including local transit routes along the Humber Station Employment Area boundary roadways and improvements to priority areas including Caledon GO Station (planned at King Street & Humber Station Road). The Highway 413 Transitway station is also proposed at Mayfield Road & Humber Station Road. These nearby transit initiatives aim to expand transit reach to existing and proposed residential and employment land uses. Having more frequent and reliable transit service, as well as improving first/last mile initiatives to existing transit stops will enhance the multi-modal transportation network in the study area.

Figure 4-3: Future Transit Network



Source: Multi-Modal Transportation Master Plan Public Information Centre #2 (Town of Caledon, May 2022)

As illustrated in **Figure 4-4**, the Town of Caledon’s 2017 Transportation Master Plan and Draft Active Transportation Master Plan proposes separated on-road facilities along Humber Station Road and Healey Road. Regional cycling facilities are also planned along Mayfield Road, Highway 50, Coleraine Drive, and The Gore Road (see **Figure 4-5**).

Figure 4-4: Future Local Cycling Network

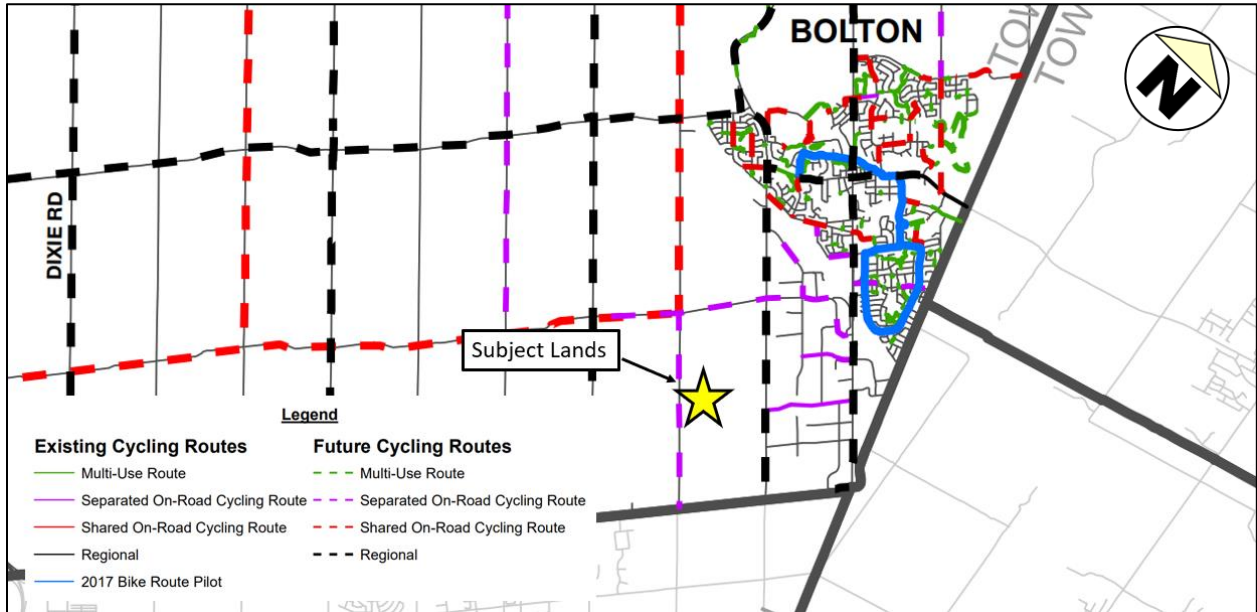

Source: Transportation Master Plan (Town of Caledon, October 2017)

Figure 4-5: Future Regional Cycling Network

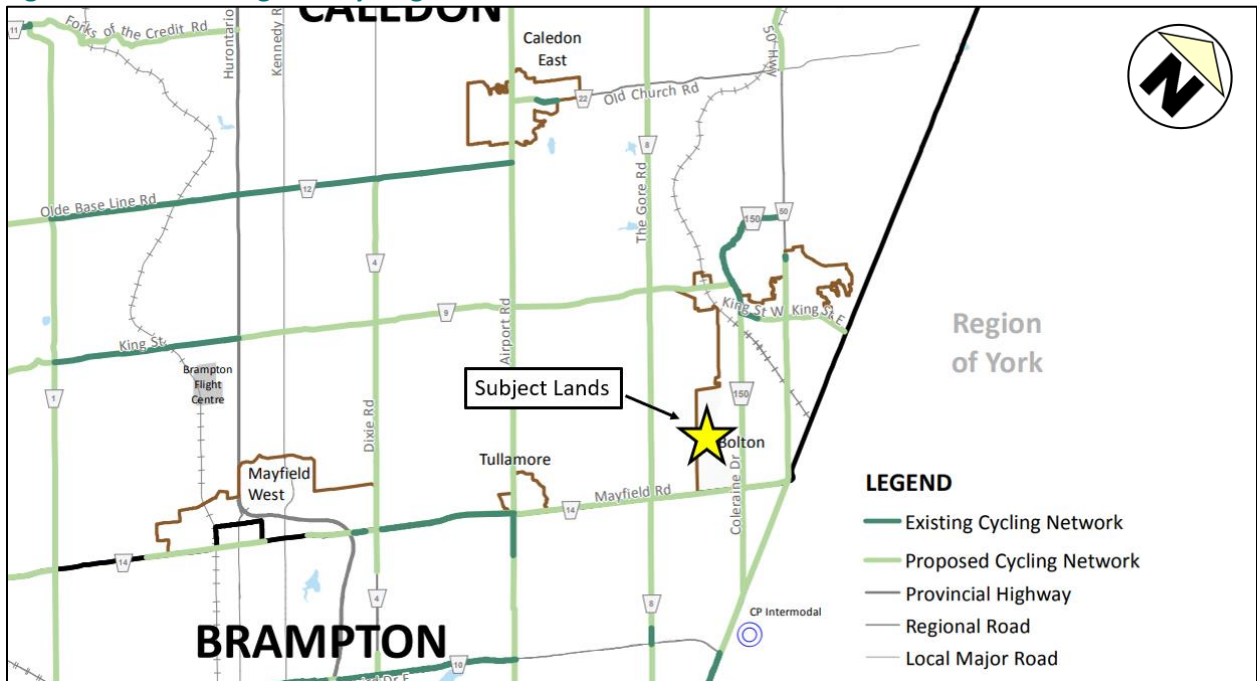

Source: Long Range Transportation Plan (Peel Region, 2019)

4.5 FUTURE BACKGROUND SYNCHRO MODEL INPUTS

Input parameters from the existing scenario were maintained with corresponding future background volumes, with the exception of the following changes:

- ▶ Coleraine Drive & Healey Road
 - Optimized splits and increased cycle length to 120 seconds during the AM and PM peak hours under the 2033 horizon year and carried through to future horizons. Splits were further optimized for the AM peak hour under the 2043 horizon.
- ▶ Clarkway Drive/Humber Station Road & Mayfield Road
 - Optimized splits during the AM and PM peak hours while maintaining the overall cycle length of 120 seconds under the 2028, 2033, and 2043 horizons.
 - Lane configuration changed to accommodate the widening of Mayfield Road, with the introduction of 3 through lanes and exclusive left and right-turning lanes for the westbound and eastbound directions, as well as and exclusive left turning lanes for the northbound and southbound directions.
- ▶ Coleraine Drive & Mayfield Road
 - Optimized splits during the AM and PM peak hours while maintaining the overall cycle length of 130 seconds under the 2043 horizon year.
 - Lane configuration changed to accommodate the widening of Mayfield Road, with the introduction of 3 through lanes for the eastbound direction and 2 through lanes for the westbound direction.
- ▶ Humber Station Road & Healey Road
 - New signalized intersection under the 2028 horizon year and carried forward to future horizons.
 - Lane configuration changed due to the signalization of the intersection, with the introduction of exclusive left-turning lanes for the northbound, southbound, and westbound directions, as well as exclusive right and left-turning lanes for the eastbound direction.
- ▶ Triangle Lands Access & Mayfield Road
 - New intersection to facilitate access for the Triangle Lands background development. The intersection is recommended as an unsignalized intersection under the 2028 and 2033 horizon years and as a signalized intersection under the 2043 horizon.
- ▶ Arterial A2 & Mayfield Road
 - New signalized intersection under the 2043 horizon year.

4.6 FUTURE BACKGROUND TRAFFIC VOLUMES

The future background traffic volumes for the weekday AM and PM peak hours under the 2028, 2033, and 2043 horizon years are illustrated in **Figure 4-6**, **Figure 4-7**, and **Figure 4-8**, respectively.

Figure 4-6: 2028 Future Background Peak Hour Traffic Volumes

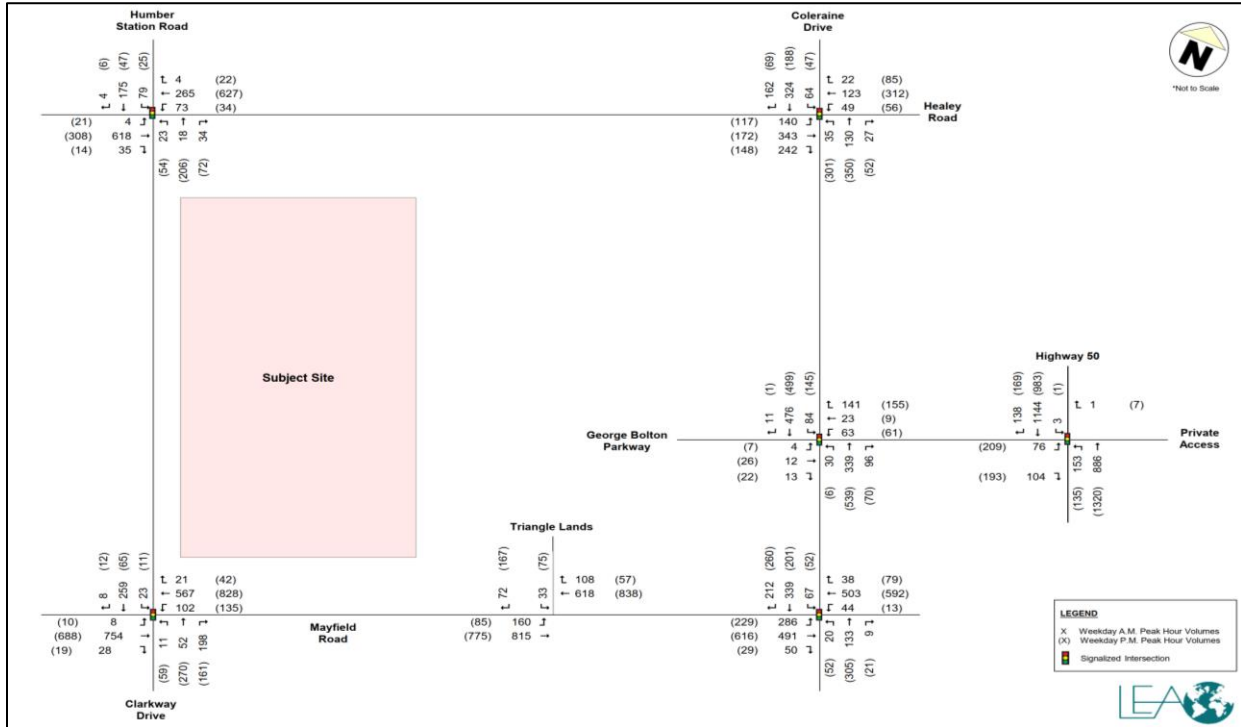

Figure 4-7: 2033 Future Background Peak Hour Traffic Volumes

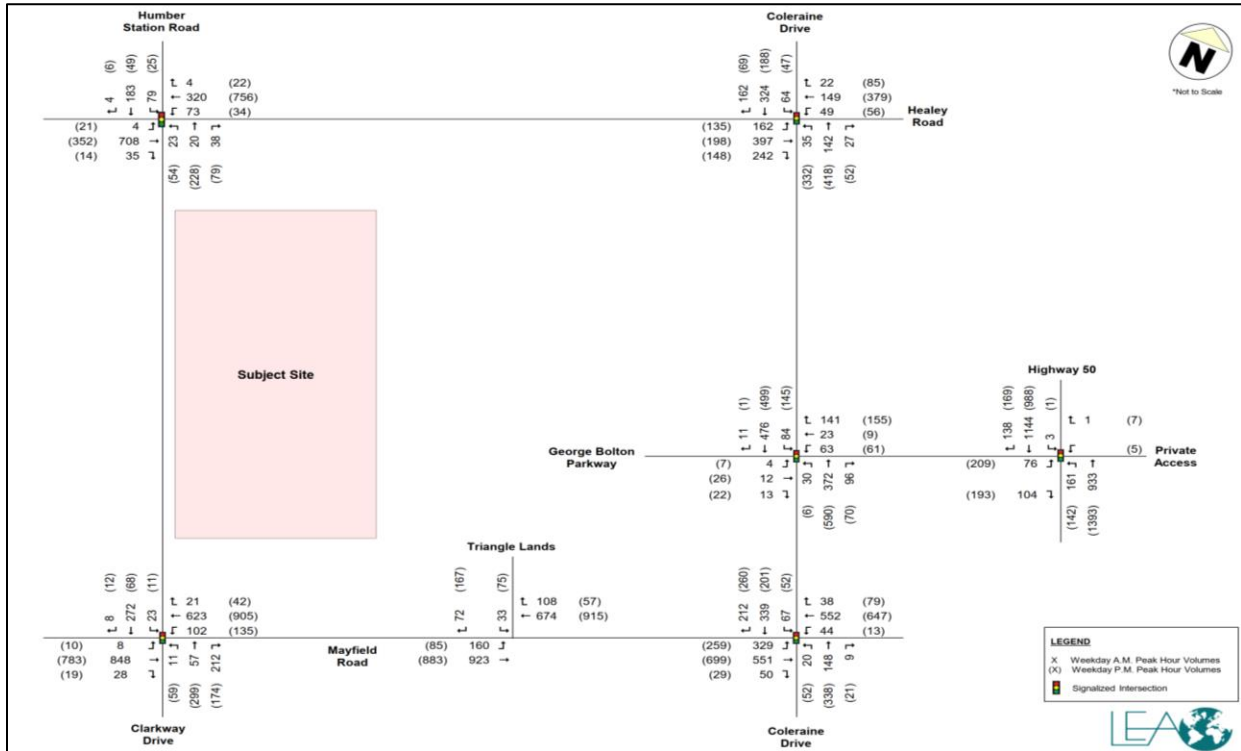
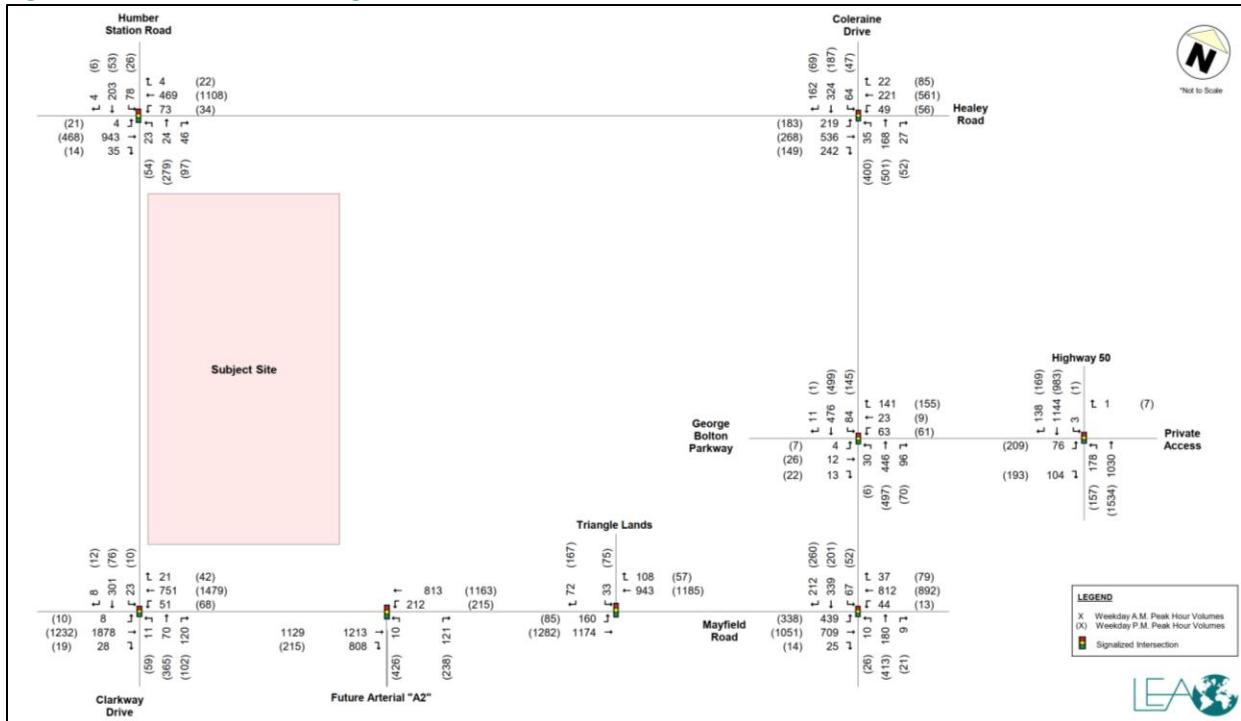

Figure 4-8: 2043 Future Background Peak Hour Traffic Volumes



5 SITE-GENERATED TRAFFIC

The full buildout of the subject lands consists of approximately 184 hectares of employment area consisting of Prestige Employment and predominately General Employment land use designations. As previously mentioned, Parcel 1 is being delivered first by the 2028 horizon year. Full buildout of the remainder of the site will occur by the 2033 horizon year. Furthermore, it is understood that access to the subject lands will be provided off the future George Bolton Parkway extension and via local connections to Humber Station Road, Healey Road, and Mayfield Road.

This section provides details regarding the site-generated traffic that has been conducted to assess the future travel demand and capacity deficiencies of the road network upon Phase 1 and full buildout of the Humber Station Employment Area lands. The calculation, distribution, and assignment of future site-generated trips are discussed below.

5.1 TRIP GENERATION

It is understood that warehousing activities are likely proposed for Parcels 1 & 2. As such, trip generation for these parcels were estimated using average baseline auto and truck trip rates from the ITE Trip Generation Manual 11th Edition for ITE LUC 150 – Warehousing in General Urban/Suburban and based on the proposed industrial GFA of 248,872 m² (2,678,769 ft²) for Parcel 1 and 51,371 m² (552,953 ft²) for Parcel 2.

Given that the proposed uses for the remainder of the site are unknown at this time, trip generation for Parcels 3-38 was estimated based on the minimum density target of 26 jobs per hectare for *Employment Areas* as outlined in the Town’s August 2023 Draft Official Plan (Policy 4.1.4). Average baseline auto and truck trips were estimated using trip rates from the ITE Trip Generation Manual 11th Edition for ITE LUC 140 – Manufacturing in General Urban/Suburban.

A summary of the site trip generation for auto and truck trips is provided in **Table 5-1** and **Table 5-2**, respectively.

Table 5-1: Trip Generation (Auto Trips)

Land Use	Description	Weekday AM Peak Hour			Weekday PM Peak Hour		
		In	Out	Total	In	Out	Total
Phase 1 (Site Access 1 - George Bolton Parkway)							
ITE LUC 150 – Warehousing 2,678,769 ft ²	Auto Trip Rate (/1000 ft ²)	0.13	0.04	0.17	0.05	0.13	0.18
	Total ITE Auto Trips	351	105	456	135	347	482
	External Auto Trips (100%)	351	105	456	135	347	482
Phase 2 (Site Access 1 - George Bolton Parkway)							
ITE LUC 150 – Warehousing 552,953 ft ²	Auto Trip Rate (/1000 ft ²)	0.13	0.04	0.17	0.05	0.13	0.18
	Total ITE Auto Trips	72	22	94	28	72	100
ITE LUC 140 – Manufacturing 1326 Employees	Auto Trip Rate (/employee)	0.23	0.09	0.32	0.11	0.20	0.31
	Total ITE Auto Trips	310	115	425	152	259	411
	External Auto Trips (100%)	382	137	519	180	331	511
Phase 2 (Site Access 2 - Humber Station)							
ITE LUC 140 – Manufacturing 52 Employees	Auto Trip Rate (/employee)	0.23	0.09	0.32	0.11	0.20	0.31
	Total ITE Auto Trips	12	4	16	6	10	16
	External Auto Trips (100%)	12	4	16	6	10	16

Land Use	Description	Weekday AM Peak Hour			Weekday PM Peak Hour		
		In	Out	Total	In	Out	Total
Phase 2 (Site Access 3 - Humber Station)							
ITE LUC 140 – Manufacturing 624 Employees	Auto Trip Rate (/employee)	0.23	0.09	0.32	0.11	0.20	0.31
	Total ITE Auto Trips	146	54	200	72	122	194
	External Auto Trips (100%)	146	54	200	72	122	194
Phase 2 (Site Access 4 - Healey)							
ITE LUC 140 – Manufacturing 598 Employees	Auto Trip Rate (/employee)	0.23	0.09	0.32	0.11	0.20	0.31
	Total ITE Auto Trips	140	52	192	69	117	186
	External Auto Trips (100%)	140	52	192	69	117	186
Phase 2 (Site Access 5 - Mayfield)							
ITE LUC 140 – Manufacturing 146 Employees	Auto Trip Rate (/employee)	0.23	0.09	0.32	0.11	0.20	0.31
	Total ITE Auto Trips	34	13	47	17	29	46
	External Auto Trips (100%)	34	13	47	17	29	46
Total							
Phase 1 Total New Auto Trips		351	105	456	135	347	482
Phase 2 Total New Auto Trips		714	260	974	344	609	953
Total New Auto Trips		1065	365	1430	479	956	1435

Table 5-2: Trip Generation (Truck Trips)

Land Use	Description	Weekday AM Peak Hour			Weekday PM Peak Hour		
		In	Out	Total	In	Out	Total
Phase 1 (Site Access 1 - George Bolton Parkway)							
ITE LUC 150 – Warehousing 2,678,769 ft ²	Truck Trip Rate (/1000 ft ²)	0.01	0.01	0.02	0.02	0.01	0.03
	Total ITE Truck Trips	28	26	54	42	39	81
	External Truck Trips (100%)	28	26	54	42	39	81
Phase 2 (Site Access 1 - George Bolton Parkway)							
ITE LUC 150 – Warehousing 552,953 ft ²	Auto Trip Rate (/1000 ft ²)	0.02	0.01	0.03	0.02	0.03	0.05
	Total ITE Auto Trips	23	16	39	25	42	67
ITE LUC 140 – Manufacturing 1326 Employees	Truck Trip Rate (/employee)	0.01	0.01	0.02	0.02	0.01	0.03
	Total ITE Truck Trips	6	5	11	9	8	17
	External Truck Trips (100%)	29	21	50	34	50	84
Phase 2 (Site Access 2 - Humber Station)							
ITE LUC 140 – Manufacturing 52 Employees	Truck Trip Rate (/employee)	0.02	0.01	0.03	0.02	0.03	0.05
	Total ITE Truck Trips	1	1	2	1	2	3
	External Truck Trips (100%)	1	1	2	1	2	3
Phase 2 (Site Access 3 - Humber Station)							
ITE LUC 140 – Manufacturing 624 Employees	Truck Trip Rate (/employee)	0.02	0.01	0.03	0.02	0.03	0.05
	Total ITE Truck Trips	11	8	19	12	20	32
	External Truck Trips (100%)	11	8	19	12	20	32
Phase 2 (Site Access 4 - Healey)							
ITE LUC 140 – Manufacturing 598 Employees	Truck Trip Rate (/employee)	0.02	0.01	0.03	0.02	0.03	0.05
	Total ITE Truck Trips	11	7	18	11	19	30
	External Truck Trips (100%)	11	7	18	11	19	30
Phase 2 (Site Access 5 - Mayfield)							
ITE LUC 140 – Manufacturing 146 Employees	Truck Trip Rate (/employee)	0.02	0.01	0.03	0.02	0.03	0.05
	Total ITE Truck Trips	3	2	5	3	5	8
	External Truck Trips (100%)	3	2	5	3	5	8

	Total					
Phase 1 Total New Truck Trips	28	26	54	42	39	81
Phase 2 Total New Truck Trips	55	39	94	61	96	157
Total New Truck Trips	83	65	148	103	135	238

Full buildout of the subject lands is anticipated to generate 1,430 two-way auto vehicle trips during the AM peak hour (1,065 inbound, 365 outbound) and 1,435 two-way auto vehicle trips during the PM peak hour (479 inbound, 956 outbound). In addition, 148 two-way truck trips (83 inbound, 65 outbound) are anticipated during the AM peak hour and 238 two-way truck trips (103 inbound, 135 outbound) are anticipated during the PM peak hour.

5.2 TRIP DISTRIBUTION AND ASSIGNMENT

The directional trip distribution of site traffic was derived using the 2016 TTS data filtered for trips originating in/destined to industrial areas during the AM and PM peak periods within Traffic Analysis Zones (TAZ) 3017 and 3191. Inbound and outbound distribution was based on the results of the peak hour for the peak direction (i.e., inbound direction based on AM in and outbound distribution based on PM out). Site traffic was assigned to the road network based on logical routing, turn restrictions, and changes in the future network.

The trip distribution for the subject lands is outlined in **Table 5-3**. Detailed TTS data is provided in **Appendix F**.

Table 5-3: Trip Distribution

Direction From/ To	Expected Route	Industrial	
		Weekday AM/PM	
		In	Out
North	Albion Vaughn Road	8%	9%
	Coleraine Drive	14%	11%
	Highway 50	-	4%
	Humber Station Road	3%	-
South	Clarkway Drive	18%	22%
	Highway 50	3%	4%
East	Healey Road	6%	3%
West	Healey Road	13%	16%
	Mayfield Road	35%	31%
Total		100%	100%

The site-generated traffic volumes for the weekday AM and PM peak hours under the 2028, 2033, and 2043 horizon years are illustrated in **Figure 5-1** to **Figure 5-6**.

Figure 5-1: Total Site-Generated Auto Peak Hour Traffic Volumes (Phase 1 - 2028)

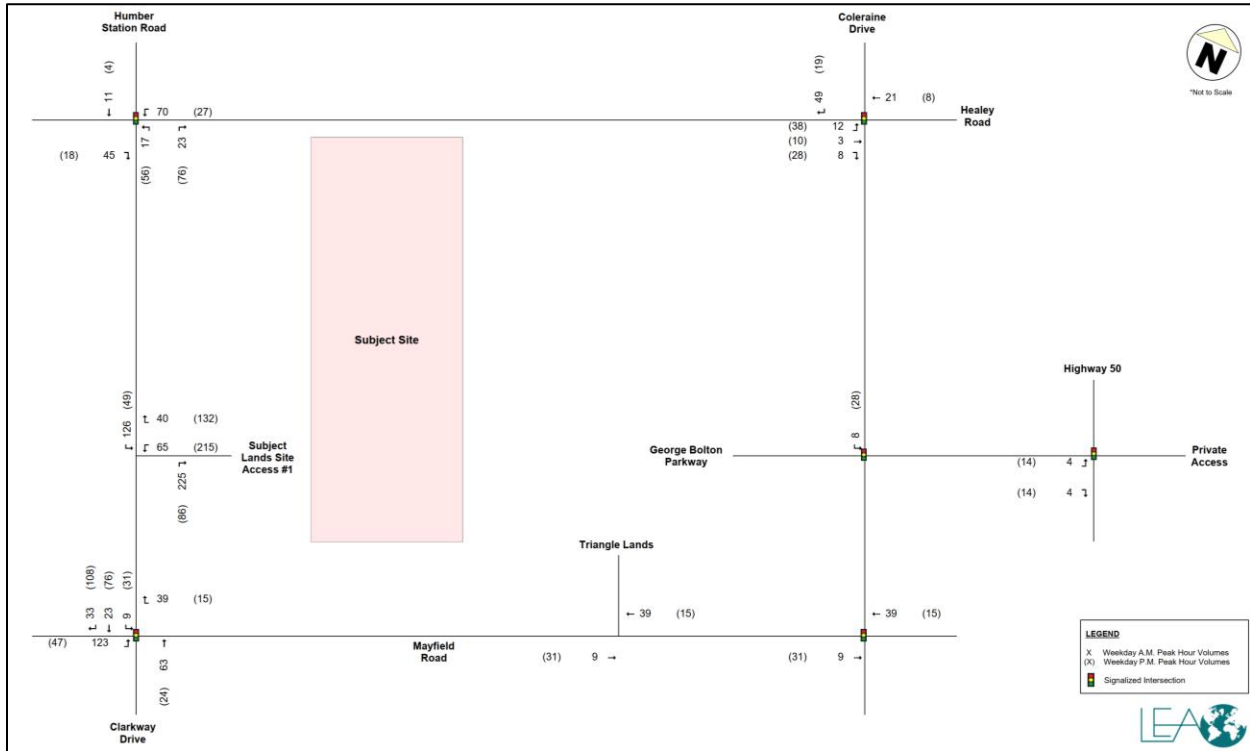

Figure 5-2: Total Site-Generated Truck Peak Hour Traffic Volumes (Phase 1 - 2028)

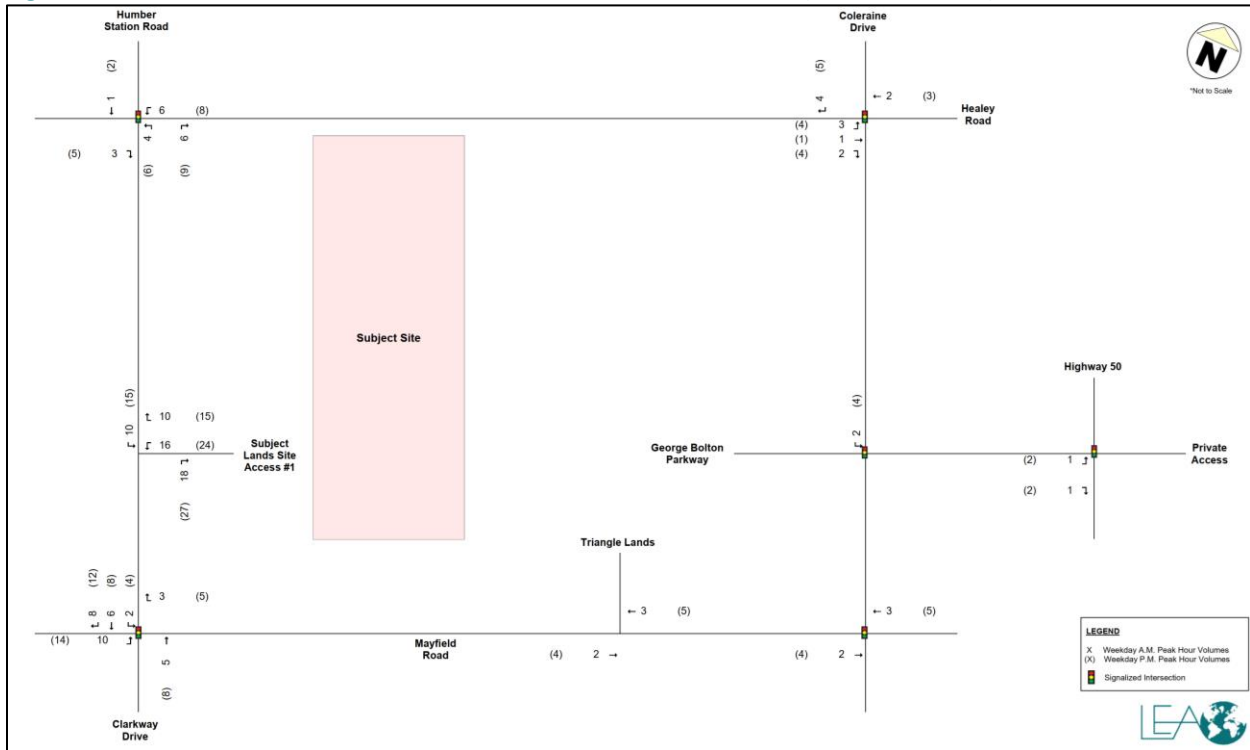

Figure 5-3: Total Site-Generated Auto Peak Hour Traffic Volumes (Full Buildout - 2033)

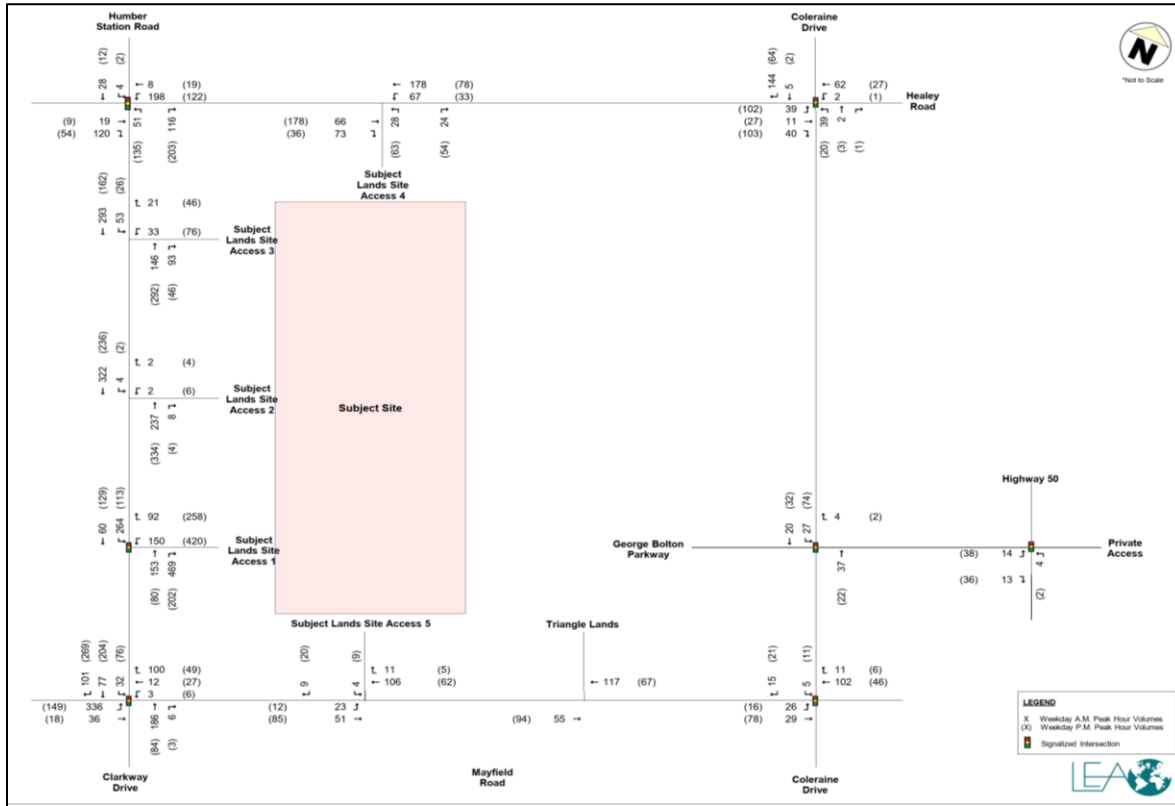

Figure 5-4: Total Site-Generated Truck Peak Hour Traffic Volumes (Full Buildout - 2033)

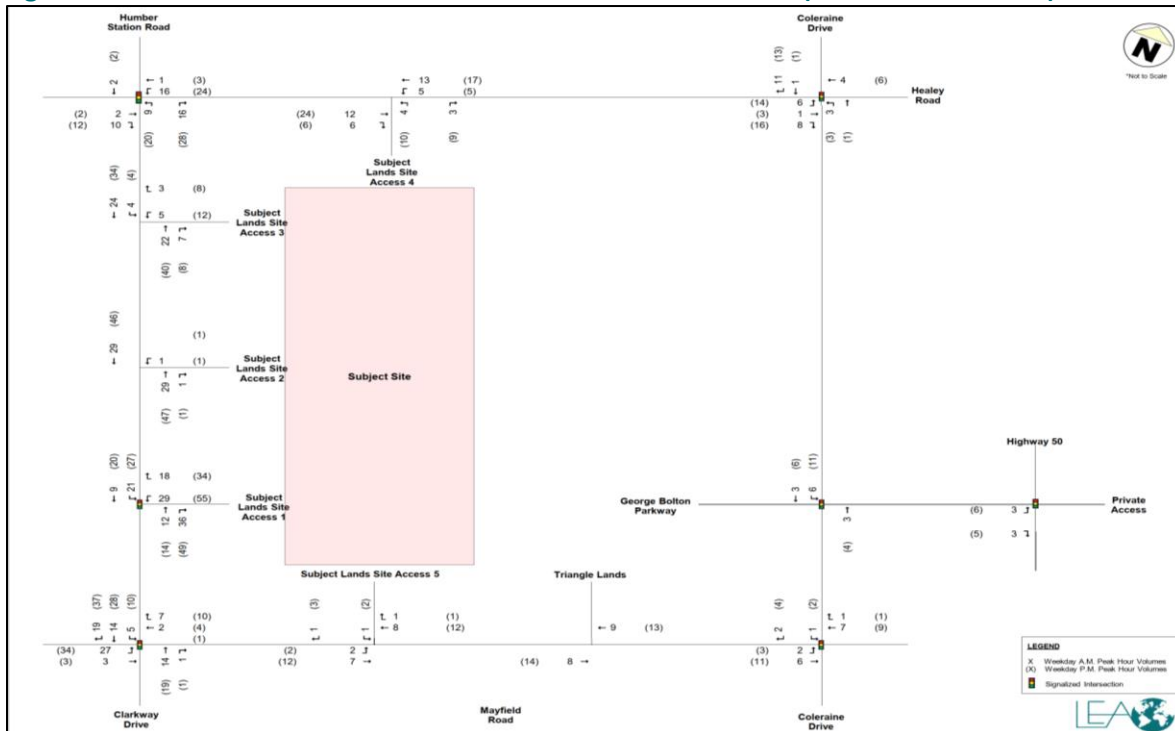

Figure 5-5: Total Site-Generated Auto Peak Hour Traffic Volumes (Full Buildout - 2043)

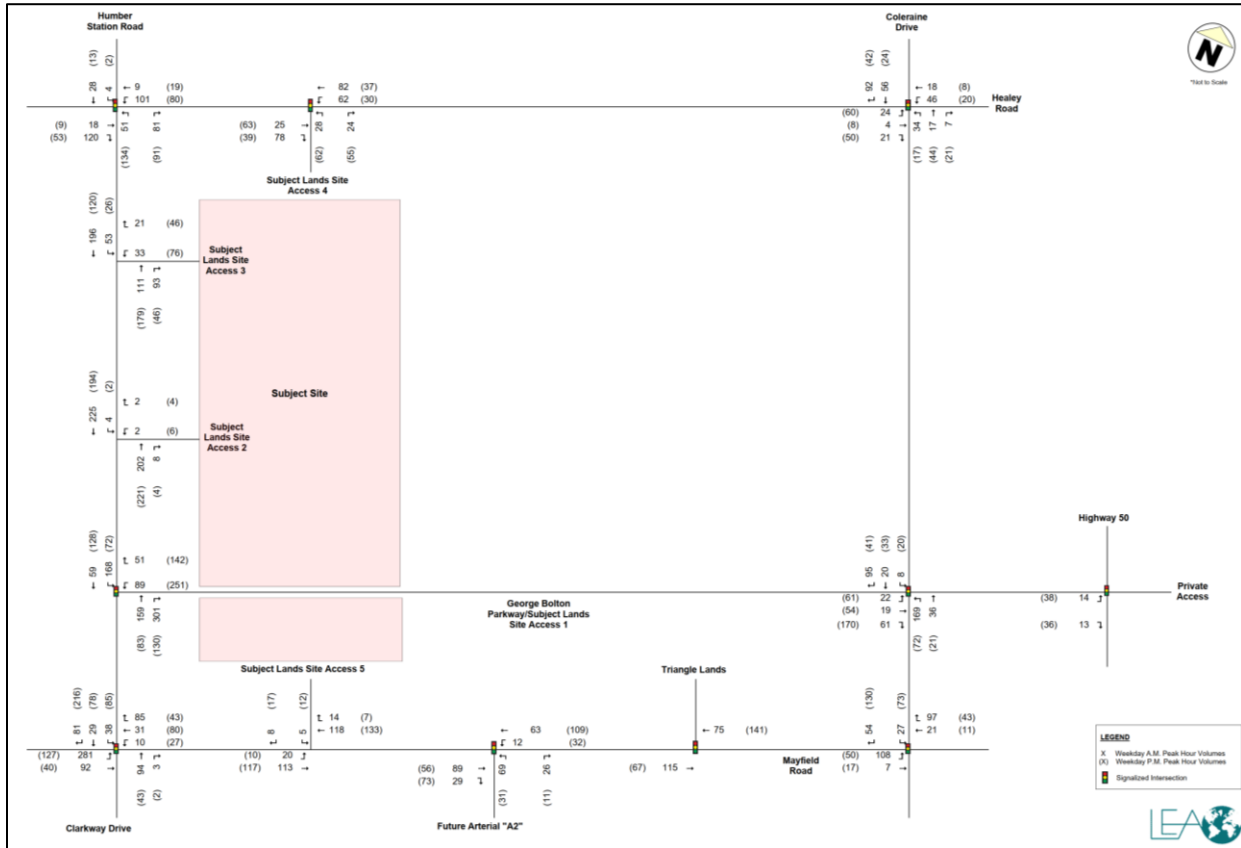
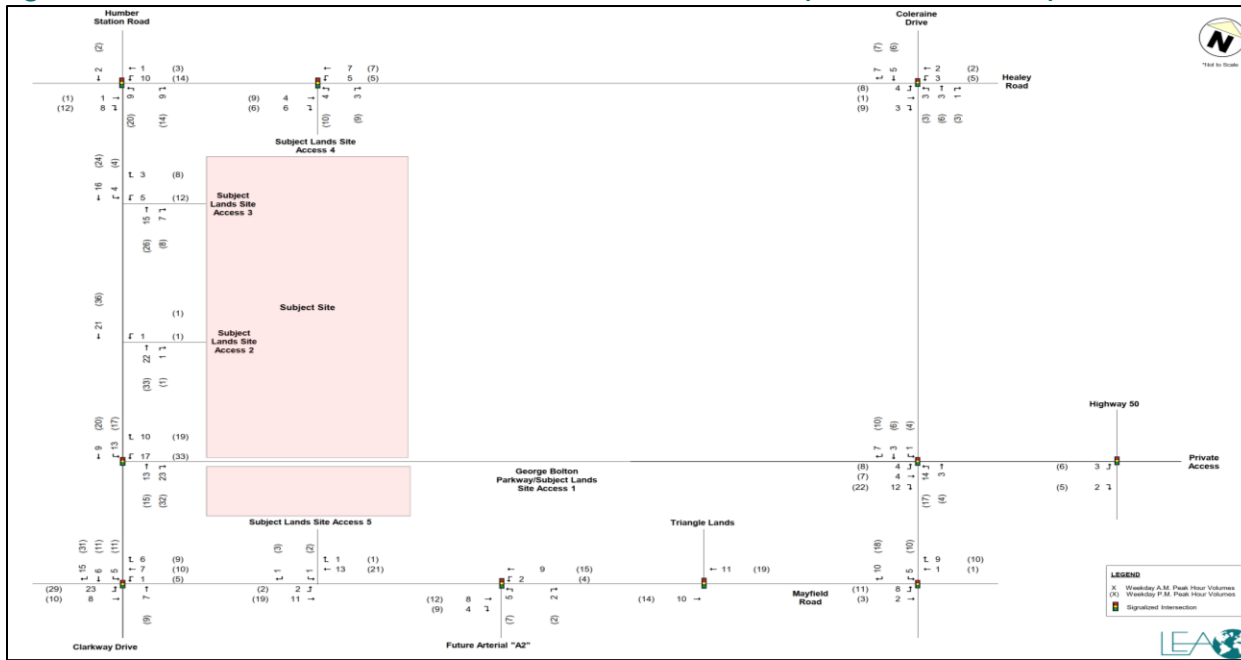

Figure 5-6: Total Site-Generated Truck Peak Hour Traffic Volumes (Full Buildout - 2043)



6 FUTURE TOTAL TRANSPORTATION CONDITIONS

The future total traffic conditions include the addition of site trips to the 2028, 2033, and 2043 background volumes.

6.1 INTERNAL NETWORK DEVELOPMENT

To support the development of the Humber Station Employment Area lands, a network of collector and/or local roads is required to provide servicing, frontage, and connectivity to the external road network. The initial recommendation for the internal road network under the 2028 horizon includes the partial buildout of George Bolton Parkway to facilitate access for Parcel 1. Under the 2033 horizon year, local connections to Humber Station Road, Healey Road, and Mayfield Road are proposed to accommodate full buildout of the subject lands.

The ultimate 2043 conditions include the full western extension of George Bolton Parkway, connecting Coleraine Drive to Humber Station Road. All five site accesses are proposed as unsignalized intersections in the interim. The future intersections of George Bolton Parkway & Humber Station Road and the future local connection off Healey Road are proposed as full-movement signalized intersections under ultimate conditions.

Of note, the planned infrastructure improvements within the site could be advanced to further the development of the ultimate road network. Furthermore, the alignment of George Bolton Parkway as well as the need and justification for additional connections will be evaluated through future master plan and environment assessment studies.

Figure 6-1 illustrates the ultimate 2043 road network.

Figure 6-1: 2043 Future Road Network

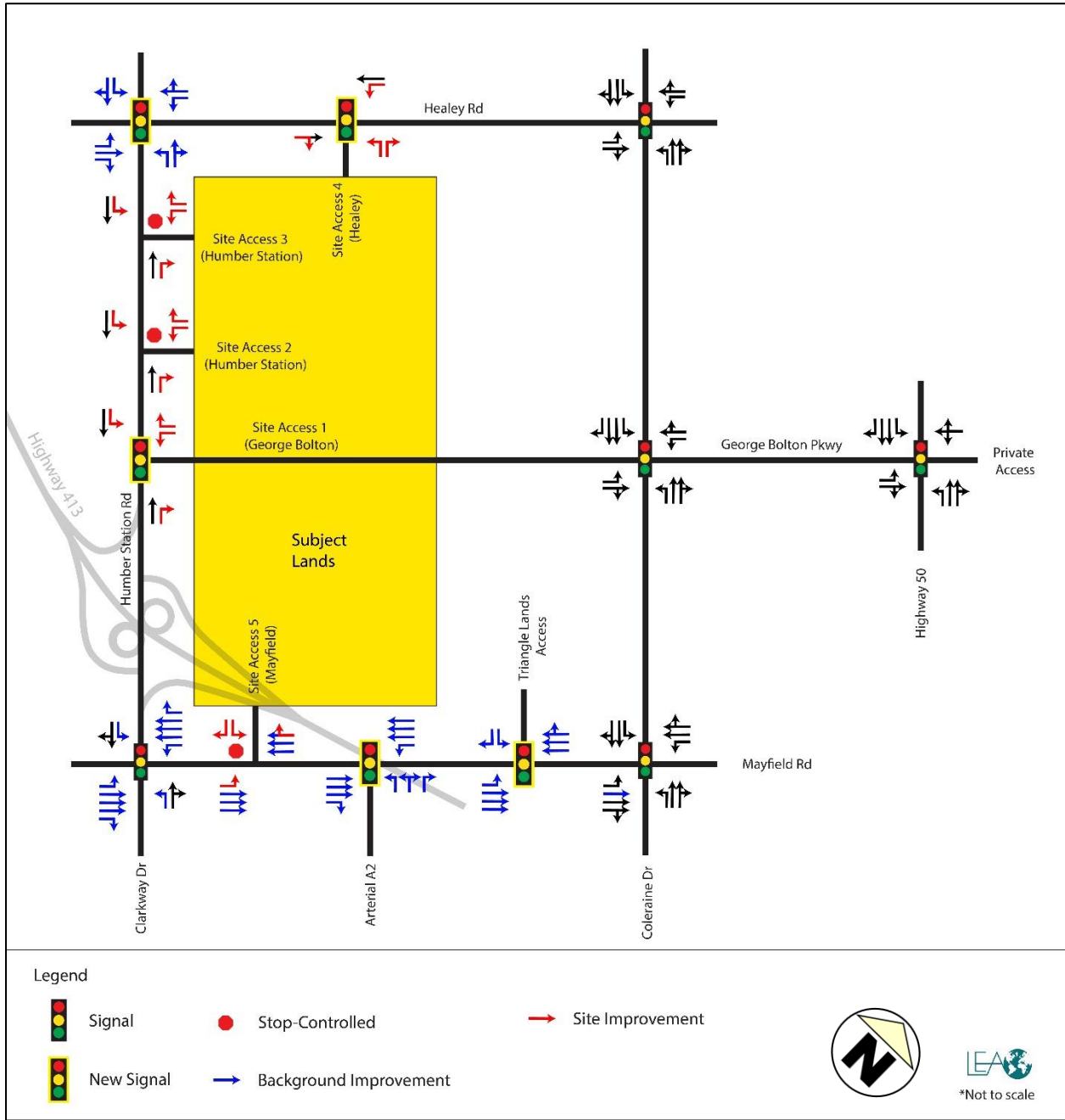

Note: Lane configuration and traffic control for the new site access intersections were based on required improvements from the intersection capacity analysis results in Section 7.

6.2 FUTURE TOTAL SYNCHRO MODEL INPUTS

Input parameters from the existing and future background scenarios were maintained with corresponding future total volumes, with the exception of the following changes:

- ▶ Humber Station Road & George Bolton Parkway (Subject Lands Site Access 1)
 - New intersection to facilitate access for the subject lands. The intersection is recommended as an unsignalized intersection under the 2028 horizon year and as a signalized intersection under the 2033 and 2043 horizons. Partial buildout of the George Bolton Parkway extension was assumed under the 2028 and 2033 horizons. Ultimate 2043 conditions include the full western extension of George Bolton Parkway, connecting Coleraine Drive to Humber Station Road.
- ▶ Subject Lands Site Access 2 & Humber Station Road
 - New intersection to facilitate access for the subject lands. The intersection is recommended as an unsignalized intersection under the 2033 and 2043 horizon years.
- ▶ Subject Lands Site Access 3 & Humber Station Road
 - New intersection to facilitate access for the subject lands. The intersection is recommended as an unsignalized intersection under the 2033 and 2043 horizon years.
- ▶ Subject Lands Site Access 4 & Healey Road
 - New intersection to facilitate access for the subject lands. The intersection is recommended as an unsignalized intersection under the 2033 horizon year and as a signalized intersection under the 2043 horizon.
- ▶ Subject Land Site Access 5 & Mayfield Road
 - New intersection to facilitate access for the subject lands. The intersection is recommended as an unsignalized intersection under the 2033 and 2043 horizon years.

6.3 FUTURE TOTAL TRAFFIC VOLUMES

The future total traffic volumes for the weekday AM and PM peak hours under the 2028, 2033, and 2043 horizon years are illustrated in **Figure 6-2**, **Figure 6-3**, and **Figure 6-4**, respectively.

Figure 6-2: 2028 Future Total Peak Hour Traffic Volumes

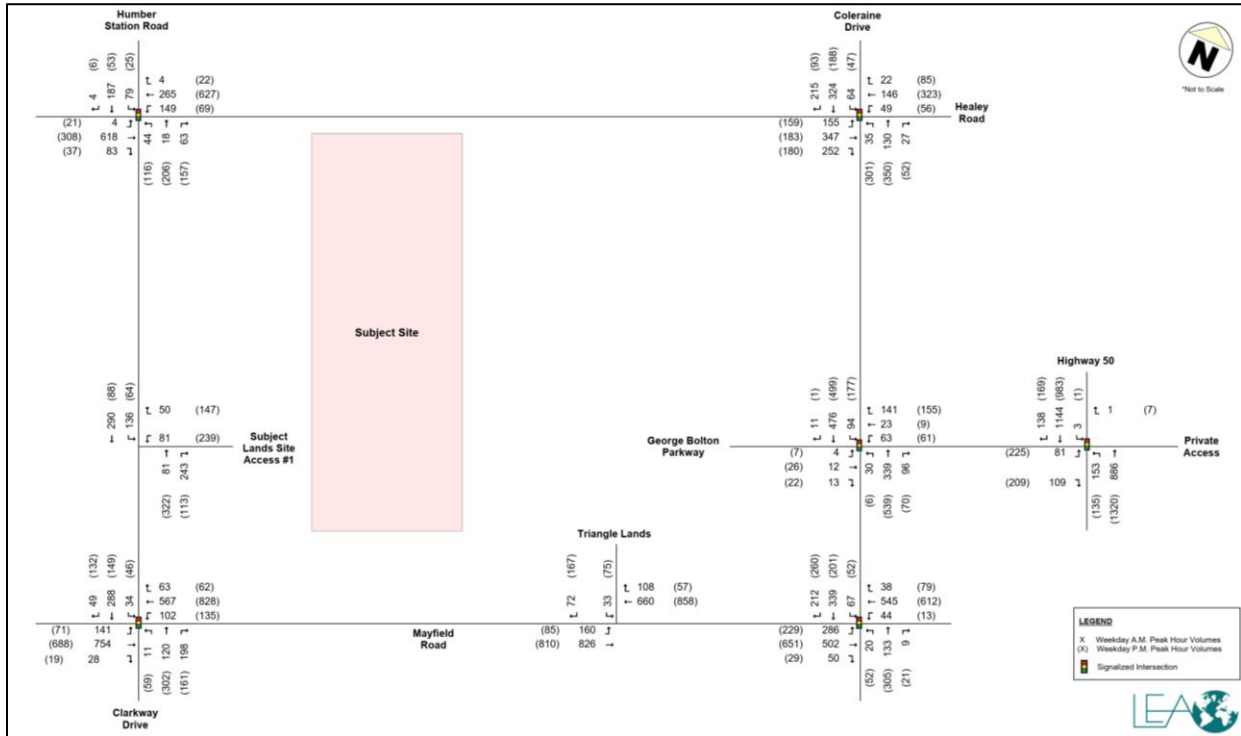

Figure 6-3: 2033 Future Total Peak Hour Traffic Volumes

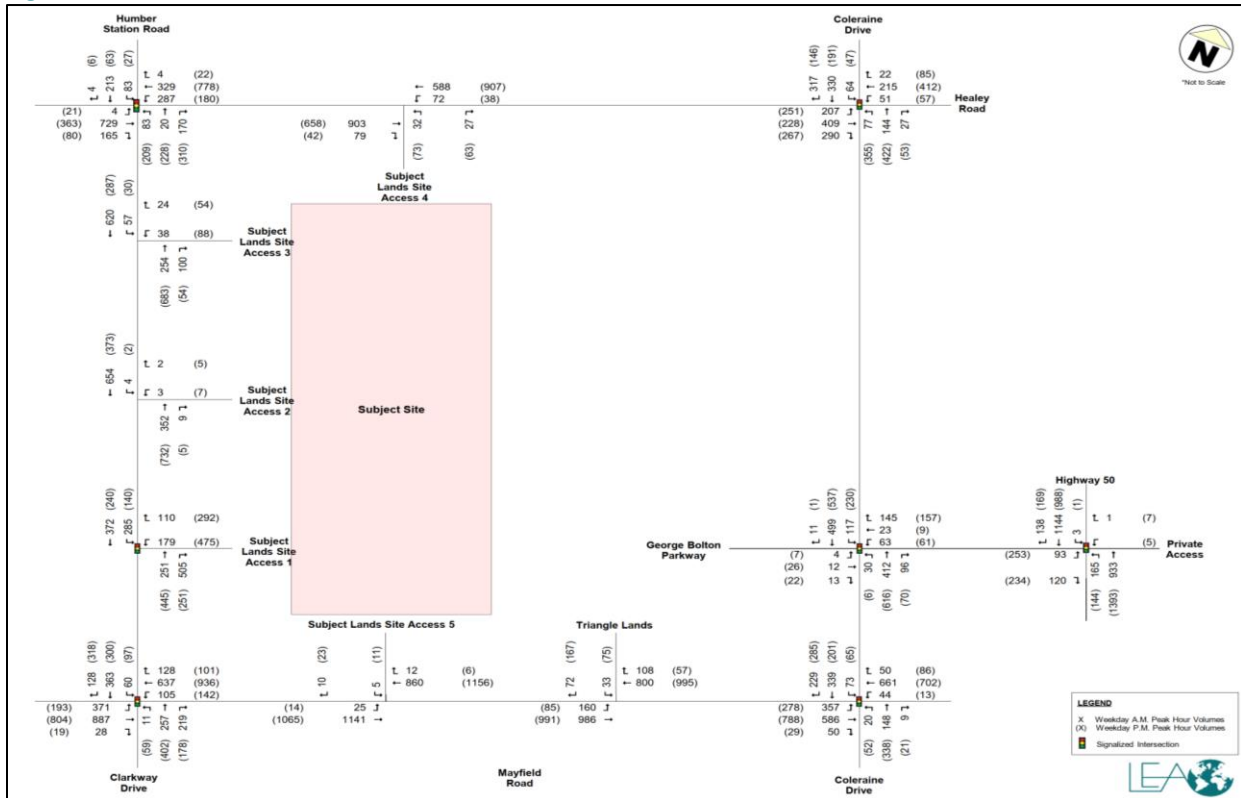
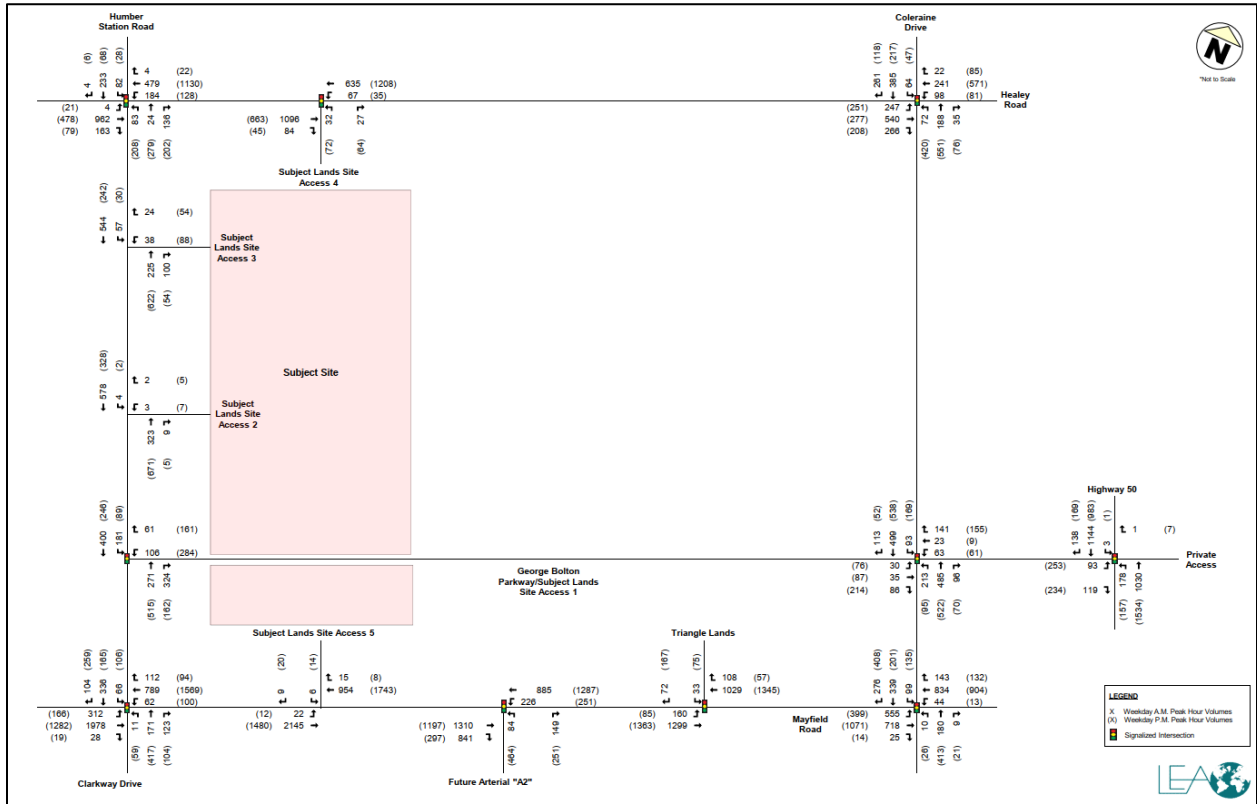

Figure 6-4: 2043 Future Total Peak Hour Traffic Volumes



7 INTERSECTION CAPACITY ANALYSIS

The intersection capacity analysis was undertaken using Synchro 11.0, which is based on the Highway Capacity Manual (HCM) (2000) and adheres to the Town of Caledon’s Transportation Impact Studies Terms of Reference and Guidelines dated March 2017. HCM 2000 and 6 results are presented for signalized and unsignalized study intersections, respectively. As per the Town of Caledon guidelines, critical movements of interest for signalized intersections were identified as those with a volume-to-capacity (v/c) ratio greater than 0.90 for overall intersection operations, through movements or shared through/turning movements and a v/c ratio greater than 1.00 for exclusive turning movements. For unsignalized intersections, critical movements were identified as those with a level-of-service (LOS) ‘E’ or greater. LOS definitions are included in **Appendix G**.

The following sections outline a comparison of the capacity analysis results under existing, future background (2028, 2033, 2043), and future total (2028, 2033, 2043) conditions. Detailed capacity analysis results are provided in the following appendices:

- ▶ **Appendix H:** Existing Intersection Capacity Analysis;
- ▶ **Appendix I:** 2028, 2033, and 2043 Future Background Intersection Capacity Analysis; and
- ▶ **Appendix J:** 2028, 2033, and 2043 Future Total Intersection Capacity Analysis.

Of note, the planned infrastructure improvements detailed within this section could be advanced to further the development of the ultimate road network.

7.1 EXISTING SIGNALIZED INTERSECTIONS

The results for the existing signalized intersections under each traffic scenario during the weekday AM and PM peak hours are summarized in the sections below.

7.1.1 Coleraine Drive & Healey Road

In order to improve traffic conditions and accommodate future traffic growth at the intersection, optimized signal timing plans, including a cycle length increased from 70 seconds to 120 seconds was applied during both peak hours. The signal timing optimizations for the future horizons are summarized in **Table 7-1**.

Table 7-1: Signal Timing Optimizations, Coleraine Drive & Healey Road

Horizon	Cycle Length (s)	Signal Timing
Existing & 2028 Weekday AM	70	
2033 Weekday AM (Optimized)	120	
2043 Weekday AM (Optimized)	120	

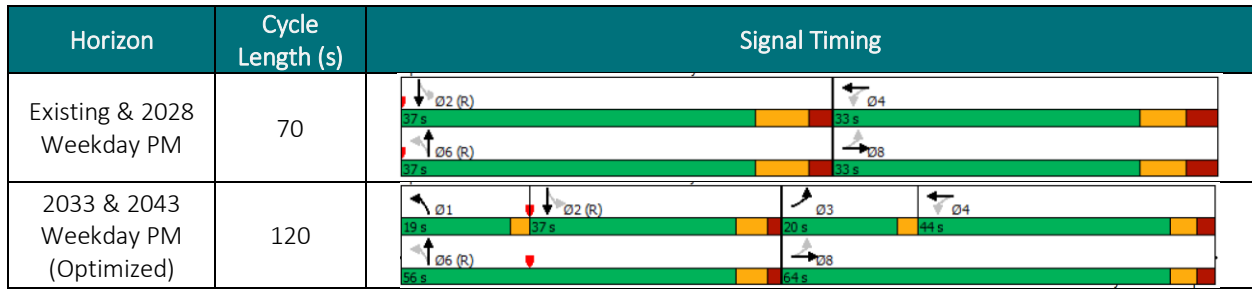

The intersection capacity analysis at Coleraine Drive & Healey Road under the 2028, 2033, and 2043 horizon years are summarized in **Table 7-2**, **Table 7-3**, and **Table 7-4**, respectively, for the weekday AM and PM peak hours.

Table 7-2: Intersection Capacity Analysis, Coleraine Drive & Healey Road (2028)

AM	Existing Conditions (2023)				Future Background (2028)				Future Total (2028)			
Mvmt	Vol	V/C	Delay (LOS)	Queue 50th (95th)	Vol	V/C	Delay (LOS)	Queue 50th (95th)	Vol	V/C	Delay (LOS)	Queue 50th (95th)
Overall	-	0.50	20 (C)	-	-	0.60	25 (C)	-	-	0.62	26 (C)	-
EBL	121	0.34	18 (B)	13 (25)	140	0.37	17 (B)	15 (29)	155	0.42	17 (B)	17 (33)
EBTR	492	0.85	33 (C)	58 (105)	585	0.94	44 (D)	74 (140)	599	0.95	46 (D)	77 (145)
WBL	24	0.28	19 (B)	3 (9)	49	0.63	33 (C)	6 (24)	49	0.63	33 (C)	6 (24)
WBTR	123	0.23	17 (B)	11 (22)	145	0.25	16 (B)	13 (26)	168	0.28	16 (B)	16 (30)
NBL	26	0.07	10 (B)	2 (7)	35	0.11	12 (B)	3 (9)	35	0.12	12 (B)	3 (9)
NBTR	123	0.10	10 (B)	4 (9)	157	0.13	12 (B)	6 (11)	157	0.13	12 (B)	6 (11)
SBL	64	0.16	11 (B)	5 (13)	64	0.17	13 (B)	6 (14)	64	0.18	13 (B)	6 (14)
SBTR	427	0.26	11 (B)	12 (22)	486	0.32	13 (B)	16 (27)	539	0.34	14 (B)	16 (27)
PM	Existing Conditions (2023)				Future Background (2028)				Future Total (2028)			
Mvmt	Vol	V/C	Delay (LOS)	Queue 50th (95th)	Vol	V/C	Delay (LOS)	Queue 50th (95th)	Vol	V/C	Delay (LOS)	Queue 50th (95th)
Overall	-	0.58	18 (B)	-	-	0.71	21 (C)	-	-	0.82	24 (C)	-
EBL	101	0.65	31 (C)	13 (27)	117	0.83	51 (D)	16 (41)	159	0.99	89 (F)	22 (58)
EBTR	272	0.52	22 (C)	26 (43)	320	0.58	22 (C)	32 (52)	363	0.62	22 (C)	34 (61)
WBL	43	0.22	20 (C)	5 (11)	56	0.30	20 (B)	6 (15)	56	0.31	18 (B)	6 (15)
WBTR	341	0.74	29 (C)	43 (63)	397	0.79	30 (C)	51 (76)	408	0.75	26 (C)	48 (79)
NBL	254	0.50	14 (B)	23 (53)	301	0.65	19 (B)	32 (80)	301	0.70	23 (C)	37 (81)
NBTR	349	0.24	9 (A)	13 (25)	402	0.29	11 (B)	17 (29)	402	0.30	12 (B)	19 (29)
SBL	47	0.13	9 (A)	3 (11)	47	0.14	10 (B)	4 (11)	47	0.15	11 (B)	4 (11)
SBTR	226	0.14	9 (A)	6 (14)	257	0.17	10 (A)	8 (16)	281	0.19	11 (B)	9 (16)

Table 7-3: Intersection Capacity Analysis, Coleraine Drive & Healey Road (2033)

AM	Existing Conditions (2023)				Future Background (2033 - Optimized)				Future Total (2033 - Optimized)			
Mvmt	Vol	V/C	Delay (LOS)	Queue 50th (95th)	Vol	V/C	Delay (LOS)	Queue 50th (95th)	Vol	V/C	Delay (LOS)	Queue 50th (95th)
Overall	-	0.50	20 (C)	-	-	0.65	30 (C)	-	-	0.76	28 (C)	-
EBL	121	0.34	18 (B)	13 (25)	162	0.36	20 (B)	31 (30)	207	0.49	11 (B)	23 (25)
EBTR	492	0.85	33 (C)	58 (105)	639	0.85	38 (D)	174 (210)	699	0.88	27 (C)	164 (187)

WBL	24	0.28	19 (B)	3 (9)	49	0.52	35 (C)	10 (23)	51	0.59	38 (D)	10 (29)
WBTR	123	0.23	17 (B)	11 (22)	171	0.29	27 (C)	30 (42)	237	0.37	26 (C)	42 (59)
NBL	26	0.07	10 (B)	2 (7)	35	0.12	20 (C)	5 (14)	77	0.37	25 (C)	13 (25)
NBTR	123	0.10	10 (B)	4 (9)	169	0.15	21 (C)	13 (24)	171	0.16	23 (C)	14 (24)
SBL	64	0.16	11 (B)	5 (13)	64	0.21	27 (C)	12 (28)	64	0.24	31 (C)	13 (28)
SBTR	427	0.26	11 (B)	12 (22)	486	0.42	29 (C)	46 (71)	647	0.57	36 (D)	59 (84)
PM	Existing Conditions (2023)				Future Background (2033 - Optimized)				Future Total (2033 - Optimized)			
Mvmt	Vol	V/C	Delay (LOS)	Queue 50th (95th)	Vol	V/C	Delay (LOS)	Queue 50th (95th)	Vol	V/C	Delay (LOS)	Queue 50th (95th)
Overall	-	0.58	18 (B)	-	-	0.79	32 (C)	-	-	1.01	48 (D)	-
EBL	101	0.65	31 (C)	13 (27)	135	0.60	21 (C)	23 (34)	251	0.99	79 (E)	56 (100)
EBTR	272	0.52	22 (C)	26 (43)	346	0.47	18 (B)	64 (94)	495	0.65	26 (C)	97 (136)
WBL	43	0.22	20 (C)	5 (11)	56	0.22	31 (C)	11 (23)	57	0.27	32 (C)	12 (25)
WBTR	341	0.74	29 (C)	43 (63)	464	0.89	56 (E)	114 (178)	497	0.99	78 (E)	133 (209)
NBL	254	0.50	14 (B)	23 (53)	332	0.71	28 (C)	61 (92)	355	0.93	56 (E)	69 (124)
NBTR	349	0.24	9 (A)	13 (25)	470	0.37	23 (C)	44 (61)	475	0.41	26 (C)	46 (62)
SBL	47	0.13	9 (A)	3 (11)	47	0.27	36 (D)	11 (23)	47	0.30	41 (D)	11 (23)
SBTR	226	0.14	9 (A)	6 (14)	257	0.31	35 (C)	26 (39)	337	0.36	38 (D)	23 (39)

Table 7-4: Intersection Capacity Analysis, Coleraine Drive & Healey Road (2043)

AM	Existing Conditions (2023)				Future Background (2043 - Optimized)				Future Total (2043 - Optimized)			
Mvmt	Vol	V/C	Delay (LOS)	Queue 50th (95th)	Vol	V/C	Delay (LOS)	Queue 50th (95th)	Vol	V/C	Delay (LOS)	Queue 50th (95th)
Overall	-	0.50	20 (C)	-	-	0.77	32 (C)	-	-	0.89	39 (D)	-
EBL	121	0.34	18 (B)	13 (25)	219	0.45	7 (A)	6 (12)	247	0.51	11 (B)	10 (29)
EBTR	492	0.85	33 (C)	58 (105)	778	0.97	39 (D)	193 (279)	806	1.00	45 (D)	156 (297)
WBL	24	0.28	19 (B)	3 (9)	49	0.55	32 (C)	5 (12)	98	0.92	87 (F)	11 (47)
WBTR	123	0.23	17 (B)	11 (22)	243	0.32	20 (C)	37 (57)	263	0.34	19 (B)	41 (62)
NBL	26	0.07	10 (B)	2 (7)	35	0.17	27 (C)	6 (14)	72	0.48	32 (C)	13 (24)
NBTR	123	0.10	10 (B)	4 (9)	195	0.21	28 (C)	18 (28)	223	0.24	29 (C)	21 (32)
SBL	64	0.16	11 (B)	5 (13)	64	0.28	36 (D)	14 (29)	64	0.31	39 (D)	14 (29)
SBTR	427	0.26	11 (B)	12 (22)	486	0.53	38 (D)	53 (72)	646	0.75	47 (D)	70 (94)
PM	Existing Conditions (2023)				Future Background (2043 - Optimized)				Future Total (2043 - Optimized)			
Mvmt	Vol	V/C	Delay (LOS)	Queue 50th (95th)	Vol	V/C	Delay (LOS)	Queue 50th (95th)	Vol	V/C	Delay (LOS)	Queue 50th (95th)
Overall	-	0.58	18 (B)	-	-	1.04	61 (E)	-	-	1.17	80 (E)	-
EBL	101	0.65	31 (C)	13 (27)	183	0.80	42 (D)	37 (62)	251	0.97	76 (E)	55 (102)
EBTR	272	0.52	22 (C)	26 (43)	417	0.53	26 (C)	91 (121)	485	0.63	25 (C)	94 (131)
WBL	43	0.22	20 (C)	5 (11)	56	0.23	29 (C)	11 (24)	81	0.39	34 (C)	17 (34)
WBTR	341	0.74	29 (C)	43 (63)	646	1.16	131 (F)	210 (296)	656	1.29	184 (F)	227 (304)
NBL	254	0.50	14 (B)	23 (53)	400	0.94	59 (E)	81 (142)	420	1.09	104 (F)	93 (180)
NBTR	349	0.24	9 (A)	13 (25)	553	0.47	27 (C)	56 (73)	627	0.53	28 (C)	65 (84)
SBL	47	0.13	9 (A)	3 (11)	47	0.33	42 (D)	11 (23)	47	0.36	44 (D)	11 (24)

SBTR	226	0.14	9 (A)	6 (14)	256	0.34	38 (D)	26 (39)	335	0.42	39 (D)	31 (47)
------	-----	------	-------	--------	-----	------	--------	---------	-----	------	--------	---------

Existing Conditions: The signalized intersection operates within capacity, with acceptable delays and an overall LOS of ‘C’ or better during the weekday AM and PM peak hours. No critical movements have been identified under existing conditions.

Future Background Conditions: Volumes from background development traffic and growth are expected to increase delays and v/c ratios at the intersection. With signal optimization, the intersection is forecasted to operate sufficiently during the AM peak hour under all horizons. However, despite signal optimization, the PM peak hour is expected to operate overcapacity under the 2043 horizon. Notably, the WBTR and NBL movements operate with capacity constraints or is approaching capacity. This can be attributed to the increase in background trips and growth along Healey Road.

Future Total Conditions: The intersection is expected to experience some increase in delays and v/c ratios when compared to future background conditions. Under the 2028 horizon and with existing signal timings, the EBTR movement during the AM peak hour and EBL movement during the PM peak hour are approaching capacity. However, both movements can sufficiently progress through the intersection within 1 cycle length.

With signal optimization under the 2033 and 2043 horizons, the intersection is forecasted to operate sufficiently during the AM peak hour with an overall LOS of ‘D’ or better. While the EBTR and WBL movements are expected to operate at capacity or approach capacity under the 2043 horizon, the movements can sufficiently progress through the intersection within 1 cycle length.

During the PM peak, the intersection is expected to operate at capacity under the 2033 horizon. While we recognize the EBL and WBTR movements are anticipated to experience worsened operations due to site traffic, all movements are forecasted to operate within capacity. Under the 2043 horizon during the PM peak hour, the intersection continues to operate with capacity constraints similar to future background conditions. Notably, the WBTR and NBL movements operate with v/c ratios greater than 1.00. It should be noted that site traffic adds at most 20 trips to these movements. The identified constraints occur under future background conditions and can be attributed to background growth. Overall, this intersection is expected to operate sufficiently under all future horizons.

7.1.2 Clarkway Drive/Humber Station Road & Mayfield Road

As per the *Peel Region Long Range Transportation Plan (2019)*, Mayfield Road is planned to be widened from 2 to 6 lanes west of Humber Station Road and from 2 to 4 lanes between Humber Station Road and Highway 50 by 2031. However, based on correspondence with Regional staff, it is understood that this improvement is scheduled for construction starting 2026. It is further understood that the widening of Mayfield Road will include realignment of the north and south legs of Humber Station Road to eliminate the existing jogged intersection and split phasing. As such, completion of these improvements has been incorporated into the analysis by the 2028 horizon year. Consistent with the recommendations in the *Peel Region Long Range Transportation Plan (2019)*, Mayfield Road was assumed to be widened to 6 lanes between Humber Station and Coleraine Drive by the 2043 horizon.

Furthermore, as per the *Mayfield Road Improvement Class Environment Assessment (April 2013)*, exclusive left and right-turning lanes for the westbound and eastbound directions, and exclusive left turning lanes for the northbound and southbound directions have been included in the analysis.

To reflect the realignment of Humber Station Road and removal of the existing split phasing, optimized signal timing plans were applied during both peak hours while maintaining the overall cycle length. The signal timing optimizations for the future horizons are summarized in **Table 7-5**.

Table 7-5: Signal Timing Optimizations, Clarkway Drive/Humber Station Road & Mayfield Road

Horizon	Cycle Length (s)	Signal Timing
Existing Weekday AM	120	
2028 Weekday AM (Optimized)	120	
2033 Weekday AM (Optimized)	120	
2043 Weekday AM (Optimized)	120	
Existing Weekday PM	120	
2028 Weekday PM (Optimized)	120	
2033 Weekday PM (Optimized)	120	
2043 Weekday PM (Optimized)	120	

The intersection capacity analysis at Clarkway Drive/Humber Station Road & Mayfield Road under the 2028, 2033, and 2043 horizon years are summarized in **Table 7-6**, **Table 7-7**, and **Table 7-8**, respectively, for the weekday AM and PM peak hours.

Table 7-6: Intersection Capacity Analysis, Clarkway Drive/Humber Station Road & Mayfield Road (2028)

AM	Existing Conditions (2023)				Future Background (2028 - Optimized)				Future Total (2028 - Optimized)				
	Mvmt	Vol	V/C	Delay (LOS)	Queue 50th (95th)	Vol	V/C	Delay (LOS)	Queue 50th (95th)	Vol	V/C	Delay (LOS)	Queue 50th (95th)
Overall	-	-	0.81	41 (D)	-	-	0.39	19 (B)	-	-	0.47	22 (C)	-
EBL	-	-	-	-	-	8	0.02	6 (A)	1 (3)	141	0.34	12 (B)	16 (36)
EBT	559	0.72	27 (C)	106 (153)	754	0.26	8 (A)	25 (38)	754	0.28	10 (B)	30 (45)	
EBR	-	-	-	-	28	0.02	6 (A)	0 (3)	28	0.02	8 (A)	0 (4)	
WBL	-	-	-	-	102	0.27	9 (A)	9 (23)	102	0.30	12 (B)	11 (27)	
WBT	541	0.79	32 (C)	110 (165)	567	0.29	8 (A)	27 (44)	567	0.31	10 (B)	33 (53)	

PM	Existing Conditions (2023)				Future Background (2028 - Optimized)				Future Total (2028 - Optimized)			
Mvmt	Vol	V/C	Delay (LOS)	Queue 50th (95th)	Vol	V/C	Delay (LOS)	Queue 50th (95th)	Vol	V/C	Delay (LOS)	Queue 50th (95th)
WBR	-	-	-	-	21	0.02	6 (A)	0 (2)	63	0.05	8 (A)	0 (6)
NBL	-	-	-	-	11	0.12	40 (D)	2 (7)	11	0.11	35 (D)	2 (7)
NBTR	170	0.89	86 (F)	44 (92)	250	0.44	43 (D)	24 (48)	318	0.68	45 (D)	58 (84)
SBL	-	-	-	-	23	0.21	41 (D)	5 (13)	34	0.29	38 (D)	7 (16)
SBTR	257	0.83	64 (E)	63 (101)	267	0.76	55 (D)	66 (89)	337	0.81	54 (D)	82 (107)
Overall	-	0.92	52 (D)	-	-	0.58	22 (C)	-	-	0.61	24 (C)	-
EBL	-	-	-	-	10	0.04	11 (B)	1 (4)	71	0.32	18 (B)	9 (26)
EBT	556	0.75	33 (C)	118 (199)	688	0.26	12 (B)	30 (46)	688	0.28	14 (B)	32 (49)
EBR	-	-	-	-	19	0.01	10 (B)	0 (2)	19	0.01	12 (B)	0 (2)
WBL	-	-	-	-	135	0.40	17 (B)	18 (42)	135	0.42	19 (B)	19 (45)
WBT	701	0.99	64 (E)	195 (290)	828	0.45	15 (B)	60 (92)	828	0.47	17 (B)	64 (98)
WBR	-	-	-	-	42	0.03	11 (B)	0 (6)	62	0.05	12 (B)	0 (8)
NBL	-	-	-	-	59	0.19	32 (C)	11 (20)	59	0.27	31 (C)	11 (21)
NBTR	413	0.88	58 (E)	99 (136)	431	0.83	50 (D)	96 (122)	463	0.84	49 (D)	104 (129)
SBL	-	-	-	-	11	0.11	31 (C)	2 (6)	46	0.46	36 (D)	9 (20)
SBTR	74	0.58	60 (E)	18 (34)	77	0.15	31 (C)	14 (24)	281	0.56	35 (D)	59 (77)

Table 7-7: Intersection Capacity Analysis, Clarkway Drive/Humber Station Road & Mayfield Road (2033)

AM	Existing Conditions (2023)				Future Background (2033 - Optimized)				Future Total (2033- Optimized)			
Mvmt	Vol	V/C	Delay (LOS)	Queue 50th (95th)	Vol	V/C	Delay (LOS)	Queue 50th (95th)	Vol	V/C	Delay (LOS)	Queue 50th (95th)
Overall	-	0.81	41 (D)	-	-	0.43	20 (B)	-	-	0.92	33 (C)	-
EBL	-	-	-	-	8	0.02	6 (A)	1 (3)	371	0.90	39 (D)	52 (111)
EBT	559	0.72	27 (C)	106 (153)	848	0.29	8 (A)	29 (45)	887	0.37	15 (B)	47 (59)
EBR	-	-	-	-	28	0.02	6 (A)	0 (3)	28	0.02	12 (B)	0 (4)
WBL	-	-	-	-	102	0.32	12 (B)	10 (31)	105	0.60	44 (D)	22 (49)
WBT	541	0.79	32 (C)	110 (165)	623	0.33	10 (B)	31 (62)	637	0.58	32 (C)	71 (91)
WBR	-	-	-	-	21	0.02	8 (A)	0 (0)	128	0.09	25 (C)	0 (13)
NBL	-	-	-	-	11	0.12	40 (D)	2 (7)	11	0.13	29 (C)	2 (7)
NBTR	170	0.89	86 (F)	44 (92)	269	0.57	46 (D)	38 (63)	476	0.87	52 (D)	104 (150)
SBL	-	-	-	-	23	0.22	41 (D)	6 (15)	60	0.65	33 (C)	12 (37)
SBTR	257	0.83	64 (E)	63 (101)	280	0.77	55 (E)	75 (103)	491	0.91	43 (D)	129 (176)
PM	Existing Conditions (2023)				Future Background (2033 - Optimized)				Future Total (2033- Optimized)			
Mvmt	Vol	V/C	Delay (LOS)	Queue 50th (95th)	Vol	V/C	Delay (LOS)	Queue 50th (95th)	Vol	V/C	Delay (LOS)	Queue 50th (95th)
Overall	-	0.92	52 (D)	-	-	0.66	24 (C)	-	-	0.95	43 (D)	-
EBL	-	-	-	-	10	0.05	13 (B)	1 (4)	193	0.91	65 (E)	32 (81)
EBT	556	0.75	33 (C)	118 (199)	783	0.31	14 (B)	37 (56)	804	0.37	21 (C)	49 (60)
EBR	-	-	-	-	19	0.01	12 (B)	0 (2)	19	0.01	17 (B)	0 (2)

WBL	-	-	-	-	135	0.49	24 (C)	20 (59)	142	0.81	67 (E)	33 (73)
WBT	701	0.99	64 (E)	195 (290)	905	0.55	20 (C)	72 (128)	936	0.88	48 (D)	119 (159)
WBR	-	-	-	-	42	0.03	14 (B)	0 (4)	101	0.08	27 (C)	0 (13)
NBL	-	-	-	-	59	0.17	30 (C)	11 (19)	59	0.66	44 (D)	12 (36)
NBTR	413	0.88	58 (E)	99 (136)	473	0.84	49 (D)	106 (131)	580	0.85	42 (D)	124 (176)
SBL	-	-	-	-	11	0.11	28 (C)	2 (7)	97	0.84	62 (E)	25 (46)
SBTR	74	0.58	60 (E)	18 (34)	80	0.13	27 (C)	13 (24)	618	0.95	53 (D)	156 (218)

Table 7-8: Intersection Capacity Analysis, Clarkway Drive/Humber Station Road & Mayfield Road (2043)

AM	Existing Conditions (2023)				Future Background (2043 - Optimized)				Future Total (2043- Optimized)			
Mvmt	Vol	V/C	Delay (LOS)	Queue 50th (95th)	Vol	V/C	Delay (LOS)	Queue 50th (95th)	Vol	V/C	Delay (LOS)	Queue 50th (95th)
Overall	-	0.81	41 (D)	-	-	0.70	21 (C)	-	-	0.86	31 (C)	-
EBL	-	-	-	-	8	0.02	10 (A)	1 (3)	312	0.79	24 (C)	37 (74)
EBT	559	0.72	27 (C)	106 (153)	1878	0.69	19 (B)	119 (168)	1978	0.84	29 (C)	162 (219)
EBR	-	-	-	-	28	0.02	10 (B)	0 (1)	28	0.02	15 (B)	0 (1)
WBL	-	-	-	-	51	0.40	26 (C)	4 (17)	62	0.51	27 (C)	6 (19)
WBT	541	0.79	32 (C)	110 (165)	751	0.28	10 (B)	27 (48)	789	0.44	23 (C)	46 (54)
WBR	-	-	-	-	21	0.02	9 (A)	0 (0)	112	0.08	16 (B)	0 (9)
NBL	-	-	-	-	11	0.12	38 (D)	2 (7)	11	0.12	31 (C)	2 (7)
NBTR	170	0.89	86 (F)	44 (92)	190	0.38	41 (D)	25 (44)	294	0.56	37 (D)	57 (80)
SBL	-	-	-	-	23	0.13	38 (D)	5 (12)	66	0.35	38 (D)	15 (30)
SBTR	257	0.83	64 (E)	63 (101)	309	0.79	54 (D)	76 (100)	440	0.87	59 (E)	114 (151)
PM	Existing Conditions (2023)				Future Background (2043 - Optimized)				Future Total (2043- Optimized)			
Mvmt	Vol	V/C	Delay (LOS)	Queue 50th (95th)	Vol	V/C	Delay (LOS)	Queue 50th (95th)	Vol	V/C	Delay (LOS)	Queue 50th (95th)
Overall	-	0.92	52 (D)	-	-	0.71	22 (C)	-	-	0.92	40 (D)	-
EBL	-	-	-	-	10	0.10	15 (B)	1 (4)	166	0.89	67 (E)	28 (71)
EBT	556	0.75	33 (C)	118 (199)	1232	0.48	18 (B)	64 (98)	1282	0.58	24 (C)	88 (104)
EBR	-	-	-	-	19	0.01	13 (B)	0 (0)	19	0.01	17 (B)	0 (0)
WBL	-	-	-	-	68	0.47	23 (C)	9 (40)	100	0.96	104 (F)	26 (64)
WBT	701	0.99	64 (E)	195 (290)	1479	0.62	15 (B)	76 (154)	1559	0.96	44 (D)	154 (188)
WBR	-	-	-	-	42	0.03	15 (B)	0 (1)	94	0.07	15 (B)	2 (5)
NBL	-	-	-	-	59	0.18	32 (C)	11 (21)	59	0.28	31 (C)	11 (23)
NBTR	413	0.88	58 (E)	99 (136)	467	0.88	56 (E)	109 (147)	521	0.93	61 (E)	123 (187)
SBL	-	-	-	-	10	0.10	50 (D)	2 (6)	106	0.69	50 (D)	12 (35)
SBTR	74	0.58	60 (E)	18 (34)	88	0.14	41 (D)	18 (30)	424	0.62	23 (C)	40 (63)

Existing Conditions: The signalized intersection operates within capacity, with acceptable delays and an overall LOS of 'D' during both weekday AM and PM peak hours. The NBTR movement during the AM peak hour experiences some delay and a LOS of 'F'; however, operates with residual capacity. During the PM peak hour, the overall intersection operates with a v/c above 0.90. Notably, the WBLTR movement is approaching capacity and operating with a LOS of 'E'. It should be noted that these conditions improve under future horizons as a result of widening of Mayfield Road from 2 to 6 lanes west of Humber Station

Road and from 2 to 4 lanes east of Humber Station Road, under the 2028 horizon, and to its ultimate 6-lane cross-section between Humber Station Road and Coleraine Drive by the 2043 horizon.

Future Background Conditions: With signal optimization and widening of Mayfield Road, the intersection operates acceptably under future background conditions with acceptable delays and an overall LOS of ‘C’ or better during both peak hours and under all horizons. No critical movements have been identified.

Future Total Conditions: The intersection is expected to experience some increase in delays and v/c ratios when compared to future background conditions. Notably, the WBT and NBTR movements during the PM peak hour under the 2043 horizon are expected to approach capacity; however, both movements are expected to operate sufficiently and with acceptable delay. No new constraints have been identified as a result of site traffic.

7.1.3 Coleraine Drive & Mayfield Road

As per the *Peel Region Long Range Transportation Plan (2019)*, Mayfield Road is planned to be widened from 2 to 4 lanes between Humber Station Road and Highway 50 by 2031. However, as previously noted, this improvement is scheduled for construction starting 2026. As such, completion of this improvement has been incorporated into the analysis by the 2028 horizon year. Furthermore, consistent with the recommendations in the *Peel Region Long Range Transportation Plan (2019)*, Mayfield Road was assumed to be widened to 6 lanes between Humber Station and Coleraine Drive by the 2043 horizon and Coleraine Drive was assumed to be widened to 4 lanes between Mayfield Road and Highway 50.

In order to improve traffic conditions and accommodate future traffic growth at the intersection, optimized signal timing plans were applied during both peak hours while maintaining the overall cycle length. The signal timing optimizations for the future horizons are summarized in **Table 7-9**.

Table 7-9: Signal Timing Optimizations, Coleraine Drive & Mayfield Road

Horizon	Cycle Length (s)	Signal Timing
Existing, 2028, & 2033 Weekday AM	130	
2043 Weekday AM (Optimized)	130	
Existing, 2028, & 2033 Weekday PM	130	
2043 Weekday PM (Optimized)	130	

The intersection capacity analysis at Coleraine Drive & Mayfield Road under the 2028, 2033, and 2043 horizon years are summarized in **Table 7-10**, **Table 7-11**, **Table 7-12**, respectively, for the weekday AM and PM peak hours.

Table 7-10: Intersection Capacity Analysis, Coleraine Drive & Mayfield Road (2028)

AM		Existing Conditions (2023)				Future Background (2028)				Future Total (2028)			
Mvmt	Vol	V/C	Delay (LOS)	Queue 50th (95th)	Vol	V/C	Delay (LOS)	Queue 50th (95th)	Vol	V/C	Delay (LOS)	Queue 50th (95th)	
Overall	-	0.55	26 (C)	-	-	0.70	27 (C)	-	-	0.71	27 (C)	-	
EBL	234	0.46	9 (A)	21 (37)	286	0.62	12 (B)	28 (51)	286	0.65	12 (B)	28 (51)	
EBTR	386	0.21	8 (A)	19 (30)	541	0.29	9 (A)	31 (47)	552	0.30	9 (A)	32 (49)	
WBL	44	0.10	14 (B)	6 (15)	44	0.13	16 (B)	7 (17)	44	0.13	16 (B)	7 (17)	
WBTR	423	0.27	15 (B)	32 (52)	541	0.35	18 (B)	47 (72)	583	0.38	19 (B)	52 (78)	
NBL	20	0.27	50 (D)	5 (15)	20	0.37	57 (E)	6 (15)	20	0.37	57 (E)	6 (15)	
NBTR	130	0.26	48 (D)	17 (28)	142	0.38	53 (D)	21 (31)	142	0.38	53 (D)	21 (31)	
SBL	15	0.11	42 (D)	4 (10)	67	0.34	43 (D)	17 (28)	67	0.34	43 (D)	17 (28)	
SBTR	473	0.74	52 (D)	67 (81)	551	0.79	54 (D)	71 (84)	551	0.79	54 (D)	71 (84)	
PM		Existing Conditions (2023)				Future Background (2028)				Future Total (2028)			
Mvmt	Vol	V/C	Delay (LOS)	Queue 50th (95th)	Vol	V/C	Delay (LOS)	Queue 50th (95th)	Vol	V/C	Delay (LOS)	Queue 50th (95th)	
Overall	-	0.41	27 (C)	-	-	0.59	26 (C)	-	-	0.60	26 (C)	-	
EBL	168	0.35	7 (A)	14 (28)	229	0.57	11 (B)	22 (40)	229	0.58	11 (B)	22 (40)	
EBTR	487	0.22	7 (A)	24 (38)	645	0.30	9 (A)	38 (55)	680	0.32	9 (A)	40 (59)	
WBL	13	0.03	11 (B)	2 (6)	13	0.04	14 (B)	2 (6)	13	0.04	14 (B)	2 (6)	
WBTR	496	0.27	13 (B)	35 (57)	671	0.40	18 (B)	57 (83)	691	0.42	18 (B)	60 (86)	
NBL	52	0.50	56 (E)	14 (28)	52	0.48	55 (E)	14 (28)	52	0.48	55 (E)	14 (28)	
NBTR	298	0.68	58 (E)	43 (57)	326	0.70	58 (E)	47 (61)	326	0.70	58 (E)	47 (61)	
SBL	25	0.22	45 (D)	6 (13)	52	0.36	43 (D)	12 (22)	52	0.36	43 (D)	12 (22)	
SBTR	420	0.44	47 (D)	27 (41)	461	0.41	44 (D)	26 (41)	461	0.41	44 (D)	26 (41)	

Table 7-11: Intersection Capacity Analysis, Coleraine Drive & Mayfield Road (2033)

AM		Existing Conditions (2023)				Future Background (2033)				Future Total (2033)			
Mvmt	Vol	V/C	Delay (LOS)	Queue 50th (95th)	Vol	V/C	Delay (LOS)	Queue 50th (95th)	Vol	V/C	Delay (LOS)	Queue 50th (95th)	
Overall	-	0.55	26 (C)	-	-	0.77	28 (C)	-	-	0.83	31 (C)	-	
EBL	234	0.46	9 (A)	21 (37)	329	0.71	15 (B)	34 (59)	357	0.79	22 (C)	38 (91)	
EBTR	386	0.21	8 (A)	19 (30)	601	0.32	9 (A)	35 (54)	636	0.34	9 (A)	38 (57)	
WBL	44	0.10	14 (B)	6 (15)	44	0.14	18 (B)	7 (17)	44	0.17	23 (C)	8 (17)	
WBTR	423	0.27	15 (B)	32 (52)	590	0.41	21 (C)	58 (79)	711	0.55	28 (C)	82 (99)	
NBL	20	0.27	50 (D)	5 (15)	20	0.37	57 (E)	6 (15)	20	0.40	59 (E)	6 (15)	
NBTR	130	0.26	48 (D)	17 (28)	157	0.42	54 (D)	24 (34)	157	0.47	56 (E)	24 (34)	
SBL	15	0.11	42 (D)	4 (10)	67	0.34	43 (D)	17 (28)	73	0.36	44 (D)	18 (30)	
SBTR	473	0.74	52 (D)	67 (81)	551	0.79	54 (D)	71 (84)	568	0.79	54 (D)	71 (84)	
PM		Existing Conditions (2023)				Future Background (2033)				Future Total (2033)			
Mvmt	Vol	V/C	Delay (LOS)	Queue 50th (95th)	Vol	V/C	Delay (LOS)	Queue 50th (95th)	Vol	V/C	Delay (LOS)	Queue 50th (95th)	
Overall	-	0.41	27 (C)	-	-	0.67	27 (C)	-	-	0.72	28 (C)	-	
EBL	168	0.35	7 (A)	14 (28)	259	0.66	14 (B)	27 (47)	278	0.72	18 (B)	30 (62)	
EBTR	487	0.22	7 (A)	24 (38)	728	0.34	10 (A)	46 (66)	817	0.39	11 (B)	54 (76)	

WBL	13	0.03	11 (B)	2 (6)	13	0.05	15 (B)	2 (6)	13	0.05	17 (B)	2 (6)
WBTR	496	0.27	13 (B)	35 (57)	726	0.45	20 (B)	68 (91)	788	0.52	23 (C)	81 (101)
NBL	52	0.50	56 (E)	14 (28)	52	0.45	53 (D)	14 (27)	52	0.46	54 (D)	14 (27)
NBTR	298	0.68	58 (E)	43 (57)	359	0.72	58 (E)	51 (66)	359	0.72	58 (E)	51 (66)
SBL	25	0.22	45 (D)	6 (13)	52	0.36	42 (D)	11 (21)	65	0.43	43 (D)	14 (25)
SBTR	420	0.44	47 (D)	27 (41)	461	0.40	43 (D)	26 (40)	486	0.45	43 (D)	30 (46)

Table 7-12: Intersection Capacity Analysis, Coleraine Drive & Mayfield Road (2043)

AM	Existing Conditions (2023)				Future Background (2043- Optimized)				Future Total (2043 - Optimized)			
Mvmt	Vol	V/C	Delay (LOS)	Queue 50th (95th)	Vol	V/C	Delay (LOS)	Queue 50th (95th)	Vol	V/C	Delay (LOS)	Queue 50th (95th)
Overall	-	0.55	26 (C)	-	-	0.90	37 (D)	-	-	1.05	60 (E)	-
EBL	234	0.46	9 (A)	21 (37)	439	0.90	48 (D)	94 (150)	555	1.08	99 (F)	180 (246)
EBTR	386	0.21	8 (A)	19 (30)	734	0.26	8 (A)	29 (37)	743	0.27	9 (A)	32 (37)
WBL	44	0.10	14 (B)	6 (15)	44	0.23	30 (C)	10 (22)	44	0.27	36 (D)	10 (22)
WBTR	423	0.27	15 (B)	32 (52)	849	0.76	40 (D)	126 (154)	977	1.04	81 (F)	168 (204)
NBL	20	0.27	50 (D)	5 (15)	10	0.23	46 (D)	3 (9)	10	0.24	45 (D)	2 (9)
NBTR	130	0.26	48 (D)	17 (28)	189	0.30	44 (D)	26 (36)	189	0.28	43 (D)	25 (36)
SBL	15	0.11	42 (D)	4 (10)	67	0.40	46 (D)	18 (32)	99	0.56	49 (D)	27 (47)
SBTR	473	0.74	52 (D)	67 (81)	551	0.85	60 (E)	73 (91)	615	0.87	61 (E)	77 (98)
PM	Existing Conditions (2023)				Future Background (2043- Optimized)				Future Total (2043 - Optimized)			
Mvmt	Vol	V/C	Delay (LOS)	Queue 50th (95th)	Vol	V/C	Delay (LOS)	Queue 50th (95th)	Vol	V/C	Delay (LOS)	Queue 50th (95th)
Overall	-	0.41	27 (C)	-	-	0.79	34 (C)	-	-	0.96	45 (D)	-
EBL	168	0.35	7 (A)	14 (28)	338	0.82	43 (D)	66 (133)	399	0.99	82 (F)	98 (185)
EBTR	487	0.22	7 (A)	24 (38)	1065	0.35	11 (B)	50 (68)	1085	0.37	13 (B)	53 (69)
WBL	13	0.03	11 (B)	2 (6)	13	0.09	28 (C)	3 (8)	13	0.10	31 (C)	3 (8)
WBTR	496	0.27	13 (B)	35 (57)	971	0.82	43 (D)	135 (170)	1036	0.96	60 (E)	149 (196)
NBL	52	0.50	56 (E)	14 (28)	26	0.19	47 (D)	6 (15)	26	0.23	48 (D)	6 (16)
NBTR	298	0.68	58 (E)	43 (57)	434	0.76	57 (E)	62 (78)	434	0.76	57 (E)	62 (78)
SBL	25	0.22	45 (D)	6 (13)	52	0.38	40 (D)	11 (20)	135	0.75	54 (D)	30 (47)
SBTR	420	0.44	47 (D)	27 (41)	461	0.37	41 (D)	25 (39)	609	0.42	39 (D)	27 (44)

Existing Conditions: The signalized intersection operates within capacity, with acceptable delays and an overall LOS of 'C' during both weekday AM and PM peak hours. No critical movements have been identified under existing conditions.

Future Background Conditions: Volumes from background developments and growth are expected to increase delays and v/c ratios. However, with the widening of Mayfield Road, the intersection continues to operate with acceptable delays and an overall LOS of 'D' or better during both peak hours under the 2028 and 2033 horizons. With signal optimization in the 2043 horizon, the intersection is expected to operate sufficiently. While the overall intersection operates with a v/c ratio of 0.90 during the AM peak hour, all movements are expected to operate with residual capacity and with acceptable delay.

Future Total Conditions: The intersection operates similarly to future background conditions during both peak hours under the 2028 and 2033 horizons. With signal optimization under the 2043 horizon, the

intersection is expected to approach capacity during the PM peak hour; however, all movements operate with a v/c ratio less than 1.00.

Despite optimization, the intersection is expected to operate with capacity constraints during the AM peak hour. Notably, the EBL and WBTR movements are expected to operate with v/c ratios greater than 1. While we recognize both movements experience worsened operations with site traffic, the subject lands contribute proportionally less trips to the network in comparison to background development and growth traffic. (i.e., 116 site-generated trips vs. 205 background generated trips to the EBL movement and 128 site-generated trips vs. 426 background generated trips to the WBTR movement). Despite capacity constraints, both movements can sufficiently progress through the intersection within 1 cycle length. Overall, this intersection is expected to operate sufficiently with optimized signal timing plans.

7.1.4 Coleraine Drive & Private Access/George Bolton Parkway

The intersection capacity analysis at Coleraine Drive & Private Access/George Bolton Parkway under the 2028, 2033, and 2043 horizon years are summarized in **Table 7-13**, **Table 7-14**, and **Table 7-15**, respectively for the weekday AM and PM peak hours.

Table 7-13: Intersection Capacity Analysis, Coleraine Drive & Private Access/George Bolton Parkway (2028)

AM	Existing Conditions (2023)				Future Background (2028)				Future Total (2028)			
Mvmt	Vol	V/C	Delay (LOS)	Queue 50th (95th)	Vol	V/C	Delay (LOS)	Queue 50th (95th)	Vol	V/C	Delay (LOS)	Queue 50th (95th)
Overall	-	0.25	13 (B)	-	-	0.29	12 (B)	-	-	0.29	12 (B)	-
EBL	4	0.04	37 (D)	1 (4)	4	0.04	37 (D)	1 (4)	4	0.04	37 (D)	1 (4)
EBTR	25	0.09	37 (D)	3 (10)	25	0.09	37 (D)	3 (10)	25	0.09	37 (D)	3 (10)
WBL	63	0.52	43 (D)	14 (26)	63	0.52	43 (D)	14 (26)	63	0.52	43 (D)	14 (26)
WBTR	164	0.25	39 (D)	5 (21)	164	0.25	39 (D)	5 (21)	164	0.25	39 (D)	5 (21)
NBL	30	0.07	5 (A)	2 (6)	30	0.08	5 (A)	2 (6)	30	0.08	5 (A)	2 (6)
NBTR	374	0.20	5 (A)	10 (19)	435	0.23	5 (A)	13 (23)	435	0.23	5 (A)	13 (23)
SBL	84	0.16	5 (A)	5 (13)	84	0.18	5 (A)	5 (13)	94	0.20	6 (A)	6 (15)
SBT	346	0.18	5 (A)	11 (20)	476	0.25	5 (A)	16 (28)	476	0.25	5 (A)	16 (28)
SBR	11	0.01	4 (A)	0 (0)	11	0.01	4 (A)	0 (0)	11	0.01	4 (A)	0 (0)
PM	Existing Conditions (2023)				Future Background (2028)				Future Total (2028)			
Mvmt	Vol	V/C	Delay (LOS)	Queue 50th (95th)	Vol	V/C	Delay (LOS)	Queue 50th (95th)	Vol	V/C	Delay (LOS)	Queue 50th (95th)
Overall	-	0.36	12 (B)	-	-	0.40	12 (B)	-	-	0.48	12 (B)	-
EBL	7	0.07	38 (D)	2 (5)	7	0.07	38 (D)	2 (5)	7	0.07	38 (D)	2 (5)
EBTR	48	0.16	39 (D)	6 (15)	48	0.16	39 (D)	6 (15)	48	0.16	39 (D)	6 (15)
WBL	61	0.48	42 (D)	14 (25)	61	0.48	42 (D)	14 (25)	61	0.48	42 (D)	14 (25)
WBTR	164	0.18	39 (D)	2 (17)	164	0.18	39 (D)	2 (17)	164	0.18	39 (D)	2 (17)
NBL	6	0.02	4 (A)	0 (2)	6	0.02	4 (A)	0 (2)	6	0.02	4 (A)	0 (2)
NBTR	492	0.26	5 (A)	16 (26)	609	0.33	5 (A)	22 (34)	609	0.33	5 (A)	22 (34)
SBL	145	0.34	7 (A)	10 (23)	145	0.39	8 (A)	11 (25)	177	0.48	10 (A)	15 (33)
SBT	431	0.23	5 (A)	15 (23)	499	0.26	5 (A)	18 (27)	499	0.26	5 (A)	18 (27)
SBR	1	0.00	4 (A)	0 (0)	1	0.00	4 (A)	0 (0)	1	0.00	4 (A)	0 (0)

Table 7-14: Intersection Capacity Analysis, Coleraine Drive & Private Access/George Bolton Parkway (2033)

AM	Existing Conditions (2023)				Future Background (2033)				Future Total (2033)			
Mvmt	Vol	V/C	Delay (LOS)	Queue 50th (95th)	Vol	V/C	Delay (LOS)	Queue 50th (95th)	Vol	V/C	Delay (LOS)	Queue 50th (95th)
Overall	-	0.25	13 (B)	-	-	0.29	12 (B)	-	-	0.31	12 (B)	-
EBL	4	0.04	37 (D)	1 (4)	4	0.04	37 (D)	1 (4)	4	0.04	37 (D)	1 (4)
EBTR	25	0.09	37 (D)	3 (10)	25	0.09	37 (D)	3 (10)	25	0.09	37 (D)	3 (10)
WBL	63	0.52	43 (D)	14 (26)	63	0.52	43 (D)	14 (26)	63	0.52	43 (D)	14 (26)
WBTR	164	0.25	39 (D)	5 (21)	164	0.25	39 (D)	5 (21)	168	0.25	39 (D)	5 (22)
NBL	30	0.07	5 (A)	2 (6)	30	0.08	5 (A)	2 (6)	30	0.08	5 (A)	2 (6)
NBTR	374	0.20	5 (A)	10 (19)	468	0.25	5 (A)	15 (26)	508	0.27	5 (A)	17 (29)
SBL	84	0.16	5 (A)	5 (13)	84	0.18	6 (A)	5 (14)	117	0.27	6 (A)	8 (19)
SBT	346	0.18	5 (A)	11 (20)	476	0.25	5 (A)	16 (28)	499	0.26	5 (A)	17 (30)
SBR	11	0.01	4 (A)	0 (0)	11	0.01	4 (A)	0 (0)	11	0.01	4 (A)	0 (0)
PM	Existing Conditions (2023)				Future Background (2033)				Future Total (2033)			
Mvmt	Vol	V/C	Delay (LOS)	Queue 50th (95th)	Vol	V/C	Delay (LOS)	Queue 50th (95th)	Vol	V/C	Delay (LOS)	Queue 50th (95th)
Overall	-	0.36	12 (B)	-	-	0.43	12 (B)	-	-	0.67	13 (B)	-
EBL	7	0.07	38 (D)	2 (5)	7	0.07	38 (D)	2 (5)	7	0.07	38 (D)	2 (5)
EBTR	48	0.16	39 (D)	6 (15)	48	0.16	39 (D)	6 (15)	48	0.16	39 (D)	6 (15)
WBL	61	0.48	42 (D)	14 (25)	61	0.48	42 (D)	14 (25)	61	0.48	42 (D)	14 (25)
WBTR	164	0.18	39 (D)	2 (17)	164	0.31	40 (D)	8 (23)	166	0.37	41 (D)	11 (26)
NBL	6	0.02	4 (A)	0 (2)	6	0.02	4 (A)	0 (2)	6	0.02	4 (A)	0 (2)
NBTR	492	0.26	5 (A)	16 (26)	660	0.35	6 (A)	25 (37)	686	0.36	6 (A)	26 (39)
SBL	145	0.34	7 (A)	10 (23)	145	0.42	9 (A)	11 (26)	230	0.71	18 (B)	26 (65)
SBT	431	0.23	5 (A)	15 (23)	499	0.26	5 (A)	18 (27)	537	0.28	5 (A)	19 (30)
SBR	1	0.00	4 (A)	0 (0)	1	0.00	4 (A)	0 (0)	1	0.00	4 (A)	0 (0)

Table 7-15: Intersection Capacity Analysis, Coleraine Drive & Private Access/George Bolton Parkway (2043)

AM	Existing Conditions (2023)				Future Background (2043)				Future Total (2043)			
Mvmt	Vol	V/C	Delay (LOS)	Queue 50th (95th)	Vol	V/C	Delay (LOS)	Queue 50th (95th)	Vol	V/C	Delay (LOS)	Queue 50th (95th)
Overall	-	0.25	13 (B)	-	-	0.32	12 (B)	-	-	0.51	13 (B)	-
EBL	4	0.04	37 (D)	1 (4)	4	0.04	37 (D)	1 (4)	30	0.28	39 (D)	7 (14)
EBTR	25	0.09	37 (D)	3 (10)	25	0.09	37 (D)	3 (10)	121	0.27	38 (D)	8 (22)
WBL	63	0.52	43 (D)	14 (26)	63	0.52	43 (D)	14 (26)	63	0.54	44 (D)	14 (26)
WBTR	164	0.25	39 (D)	5 (21)	164	0.25	39 (D)	5 (21)	164	0.24	38 (D)	5 (21)
NBL	30	0.07	5 (A)	2 (6)	30	0.08	5 (A)	2 (6)	213	0.50	10 (B)	19 (45)
NBTR	374	0.20	5 (A)	10 (19)	542	0.28	6 (A)	18 (31)	581	0.31	6 (A)	21 (35)
SBL	84	0.16	5 (A)	5 (13)	84	0.20	6 (A)	5 (14)	93	0.23	6 (A)	6 (16)
SBT	346	0.18	5 (A)	11 (20)	476	0.25	5 (A)	16 (28)	499	0.26	6 (A)	18 (31)
SBR	11	0.01	4 (A)	0 (0)	11	0.01	4 (A)	0 (0)	113	0.09	5 (A)	0 (6)
PM	Existing Conditions (2023)				Future Background (2043)				Future Total (2043)			

Mvmt	Vol	V/C	Delay (LOS)	Queue 50th (95th)	Vol	V/C	Delay (LOS)	Queue 50th (95th)	Vol	V/C	Delay (LOS)	Queue 50th (95th)
Overall	-	0.36	12 (B)	-	-	0.38	12 (B)	-	-	0.62	20 (C)	-
EBL	7	0.07	38 (D)	2 (5)	7	0.07	38 (D)	2 (5)	76	0.46	36 (D)	16 (25)
EBTR	48	0.16	39 (D)	6 (15)	48	0.16	39 (D)	6 (15)	301	0.76	46 (D)	44 (59)
WBL	61	0.48	42 (D)	14 (25)	61	0.48	42 (D)	14 (25)	61	0.88	97 (F)	15 (29)
WBTR	164	0.18	39 (D)	2 (17)	164	0.18	39 (D)	2 (17)	164	0.16	32 (C)	2 (14)
NBL	6	0.02	4 (A)	0 (2)	6	0.02	4 (A)	0 (2)	95	0.31	10 (B)	10 (24)
NBTR	492	0.26	5 (A)	16 (26)	567	0.31	5 (A)	20 (31)	592	0.36	9 (A)	31 (52)
SBL	145	0.34	7 (A)	10 (23)	145	0.37	7 (A)	11 (24)	169	0.53	15 (B)	21 (50)
SBT	431	0.23	5 (A)	15 (23)	499	0.26	5 (A)	18 (27)	538	0.32	9 (A)	29 (47)
SBR	1	0.00	4 (A)	0 (0)	1	0.00	4 (A)	0 (0)	52	0.05	7 (A)	0 (5)

Existing Conditions: The signalized intersection operates within capacity, with acceptable delays and an overall LOS of 'B' during both weekday AM and PM peak hours. No critical movements have been identified under existing conditions.

Future Background Conditions: The intersection is expected to operate similarly to existing conditions during both peak hours and under all horizon years. No new constraints have been identified.

Future Total Conditions: Minor increases in delay and v/c ratios are expected under future total conditions compared to future background conditions during both weekday peak hours under all horizon years. While the WBL movement during the PM peak hour under the 2043 horizon year is expected to experience an increase in v/c ratio and delay, site traffic does not contribute to this movement. The WBL continues to operate within capacity and with acceptable delays. No new constraints have been identified as a result of site traffic.

7.1.5 Highway 50 & Private Access/George Bolton Parkway

The intersection capacity analysis at Highway 50 & Private Access/George Bolton Parkway under the 2028, 2033, and 2043 horizon years are summarized in **Table 7-16**, **Table 7-17**, and **Table 7-18**, respectively, for the weekday AM and PM peak hours.

Table 7-16: Intersection Capacity Analysis, Highway 50 & Private Access/George Bolton Parkway (2028)

AM	Existing Conditions (2023)				Future Background (2028)				Future Total (2028)			
Mvmt	Vol	V/C	Delay (LOS)	Queue 50th (95th)	Vol	V/C	Delay (LOS)	Queue 50th (95th)	Vol	V/C	Delay (LOS)	Queue 50th (95th)
Overall	-	0.53	11 (B)	-	-	0.55	11 (B)	-	-	0.56	11 (B)	-
EBL	76	0.59	57 (E)	19 (34)	76	0.59	57 (E)	19 (34)	81	0.60	58 (E)	20 (36)
EBTR	104	0.09	48 (D)	0 (4)	104	0.09	48 (D)	0 (4)	109	0.10	48 (D)	0 (6)
WBLTR	1	0.00	47 (D)	0 (0)	1	0.00	47 (D)	0 (0)	1	0.00	47 (D)	0 (0)
NBL	146	0.51	7 (A)	6 (15)	153	0.53	8 (A)	7 (15)	153	0.54	8 (A)	7 (16)
NBTR	844	0.33	4 (A)	28 (45)	886	0.35	4 (A)	30 (48)	886	0.35	4 (A)	31 (49)
SBL	3	0.01	6 (A)	0 (2)	3	0.01	6 (A)	0 (2)	3	0.01	7 (A)	0 (2)
SBT	1125	0.52	10 (B)	68 (108)	1144	0.53	11 (B)	70 (114)	1144	0.54	11 (B)	72 (116)
SBR	138	0.10	7 (A)	0 (9)	138	0.10	7 (A)	1 (9)	138	0.10	7 (A)	1 (9)
PM	Existing Conditions (2023)				Future Background (2028)				Future Total (2028)			

Mvmt	Vol	V/C	Delay (LOS)	Queue 50th (95th)	Vol	V/C	Delay (LOS)	Queue 50th (95th)	Vol	V/C	Delay (LOS)	Queue 50th (95th)
Overall	-	0.63	17 (B)	-	-	0.65	17 (B)	-	-	0.67	18 (B)	-
EBL	209	0.83	65 (E)	52 (79)	209	0.83	65 (E)	52 (79)	225	0.85	68 (E)	55 (92)
EBTR	193	0.14	40 (D)	0 (15)	193	0.17	40 (D)	2 (22)	209	0.22	40 (D)	5 (27)
WBLTR	7	0.00	39 (D)	0 (0)	7	0.00	39 (D)	0 (0)	7	0.00	38 (D)	0 (0)
NBL	129	0.41	8 (A)	9 (18)	135	0.48	9 (A)	10 (19)	135	0.50	10 (A)	11 (19)
NBTR	1257	0.55	10 (B)	79 (107)	1320	0.58	10 (B)	86 (116)	1320	0.59	11 (B)	91 (116)
SBL	1	0.00	9 (A)	0 (1)	1	0.01	9 (A)	0 (1)	1	0.01	10 (A)	0 (1)
SBT	873	0.43	13 (B)	63 (81)	983	0.49	14 (B)	75 (95)	983	0.49	15 (B)	77 (95)
SBR	169	0.12	10 (B)	0 (10)	169	0.12	10 (B)	0 (10)	169	0.12	11 (B)	0 (10)

Table 7-17: Intersection Capacity Analysis, Highway 50 & Private Access/George Bolton Parkway (2033)

AM	Existing Conditions (2023)				Future Background (2033)				Future Total (2033)			
Mvmt	Vol	V/C	Delay (LOS)	Queue 50th (95th)	Vol	V/C	Delay (LOS)	Queue 50th (95th)	Vol	V/C	Delay (LOS)	Queue 50th (95th)
Overall	-	0.53	11 (B)	-	-	0.57	11 (B)	-	-	0.60	12 (B)	-
EBL	76	0.59	57 (E)	19 (34)	76	0.59	57 (E)	19 (34)	93	0.65	60 (E)	23 (40)
EBTR	104	0.09	48 (D)	0 (4)	104	0.09	48 (D)	0 (4)	120	0.10	47 (D)	0 (9)
WBLTR	1	0.00	47 (D)	0 (0)	1	0.00	47 (D)	0 (0)	1	0.00	46 (D)	0 (0)
NBL	146	0.51	7 (A)	6 (15)	161	0.55	8 (A)	7 (16)	165	0.57	9 (A)	8 (18)
NBTR	844	0.33	4 (A)	28 (45)	933	0.37	4 (A)	32 (52)	933	0.37	5 (A)	35 (57)
SBL	3	0.01	6 (A)	0 (2)	3	0.01	7 (A)	0 (2)	3	0.01	7 (A)	0 (2)
SBT	1125	0.52	10 (B)	68 (108)	1144	0.54	11 (B)	71 (117)	1144	0.55	12 (B)	76 (121)
SBR	138	0.10	7 (A)	0 (9)	138	0.10	7 (A)	1 (9)	138	0.10	8 (A)	1 (10)
PM	Existing Conditions (2023)				Future Background (2033)				Future Total (2033)			
Mvmt	Vol	V/C	Delay (LOS)	Queue 50th (95th)	Vol	V/C	Delay (LOS)	Queue 50th (95th)	Vol	V/C	Delay (LOS)	Queue 50th (95th)
Overall	-	0.63	17 (B)	-	-	0.68	17 (B)	-	-	0.72	21 (C)	-
EBL	209	0.83	65 (E)	52 (79)	209	0.83	65 (E)	52 (79)	253	0.91	77 (E)	63 (112)
EBTR	193	0.14	40 (D)	0 (15)	193	0.17	40 (D)	2 (22)	234	0.30	39 (D)	10 (36)
WBLTR	7	0.00	39 (D)	0 (0)	12	0.01	39 (D)	0 (0)	12	0.01	36 (D)	0 (0)
NBL	129	0.41	8 (A)	9 (18)	142	0.51	10 (A)	11 (20)	144	0.55	12 (B)	12 (20)
NBTR	1257	0.55	10 (B)	79 (107)	1393	0.61	11 (B)	94 (126)	1393	0.63	13 (B)	104 (126)
SBL	1	0.00	9 (A)	0 (1)	1	0.01	9 (A)	0 (1)	1	0.01	11 (B)	0 (1)
SBT	873	0.43	13 (B)	63 (81)	988	0.49	14 (B)	76 (96)	988	0.51	16 (B)	78 (96)
SBR	169	0.12	10 (B)	0 (10)	169	0.12	10 (B)	0 (10)	169	0.12	12 (B)	0 (10)

Table 7-18: Intersection Capacity Analysis, Highway 50 & Private Access/George Bolton Parkway (2043)

AM	Existing Conditions (2023)				Future Background (2043)				Future Total (2043)			
Mvmt	Vol	V/C	Delay (LOS)	Queue 50th (95th)	Vol	V/C	Delay (LOS)	Queue 50th (95th)	Vol	V/C	Delay (LOS)	Queue 50th (95th)
Overall	-	0.53	11 (B)	-	-	0.60	11 (B)	-	-	0.62	12 (B)	-
EBL	76	0.59	57 (E)	19 (34)	76	0.59	57 (E)	19 (34)	93	0.65	60 (E)	23 (40)

EBTR	104	0.09	48 (D)	0 (4)	104	0.09	48 (D)	0 (4)	119	0.10	47 (D)	0 (9)
WBLTR	1	0.00	47 (D)	0 (0)	1	0.00	47 (D)	0 (0)	1	0.00	46 (D)	0 (0)
NBL	146	0.51	7 (A)	6 (15)	178	0.58	9 (A)	8 (19)	178	0.60	10 (B)	9 (22)
NBTR	844	0.33	4 (A)	28 (45)	1030	0.40	5 (A)	37 (59)	1030	0.41	5 (A)	40 (64)
SBL	3	0.01	6 (A)	0 (2)	3	0.01	7 (A)	0 (2)	3	0.01	7 (A)	0 (2)
SBT	1125	0.52	10 (B)	68 (108)	1144	0.54	12 (B)	74 (121)	1144	0.55	12 (B)	78 (121)
SBR	138	0.10	7 (A)	0 (9)	138	0.10	8 (A)	1 (10)	138	0.10	8 (A)	1 (10)
PM	Existing Conditions (2023)				Future Background (2043)				Future Total (2043)			
Mvmt	Vol	V/C	Delay (LOS)	Queue 50th (95th)	Vol	V/C	Delay (LOS)	Queue 50th (95th)	Vol	V/C	Delay (LOS)	Queue 50th (95th)
Overall	-	0.63	17 (B)	-	-	0.72	18 (B)	-	-	0.77	21 (C)	-
EBL	209	0.83	65 (E)	52 (79)	209	0.83	65 (E)	52 (79)	253	0.91	77 (E)	63 (111)
EBTR	193	0.14	40 (D)	0 (15)	193	0.17	40 (D)	2 (22)	234	0.30	39 (D)	10 (36)
WBLTR	7	0.00	39 (D)	0 (0)	7	0.00	39 (D)	0 (0)	7	0.00	36 (D)	0 (0)
NBL	129	0.41	8 (A)	9 (18)	157	0.55	10 (B)	12 (22)	157	0.58	13 (B)	13 (22)
NBTR	1257	0.55	10 (B)	79 (107)	1534	0.67	12 (B)	111 (150)	1534	0.70	14 (B)	123 (150)
SBL	1	0.00	9 (A)	0 (1)	1	0.01	10 (A)	0 (1)	1	0.01	11 (B)	0 (1)
SBT	873	0.43	13 (B)	63 (81)	983	0.49	14 (B)	76 (95)	983	0.51	16 (B)	77 (95)
SBR	169	0.12	10 (B)	0 (10)	169	0.12	10 (B)	0 (10)	169	0.12	12 (B)	0 (10)

Existing Conditions: The signalized intersection operates within capacity, with acceptable delays and an overall LOS of 'B' during both weekday AM and PM peak hours. No critical movements have been identified under existing conditions.

Future Background Conditions: The intersection is expected to operate similarly to existing conditions during both peak hours. No new constraints have been identified.

Future Total Conditions: Minor increases in delay and v/c ratio are expected under futural total conditions compared to future background conditions during both weekday peak hours. No new constraints have been identified as a result of site traffic.

7.2 FUTURE SIGNALIZED INTERSECTIONS

The results for the future signalized intersections under each traffic scenario during the weekday AM and PM peak hours are summarized in the sections below.

7.2.1 Humber Station Road & Healey Road

As per *Town of Caledon Transportation Master Plan (2017)*, Humber Station Road & Healey Road is planned to be signalized by 2031. However, this improvement was applied under the 2028 horizon year to accommodate future traffic volumes. The recommended signal timing plan under future conditions is summarized in **Table 7-19**. Furthermore, exclusive left-turning lanes are recommended for the northbound, southbound, and westbound directions while exclusive right and left-turning lanes are recommended for the eastbound direction.

Table 7-19: Recommended Signal Timing Plan, Humber Station Road & Healey Road

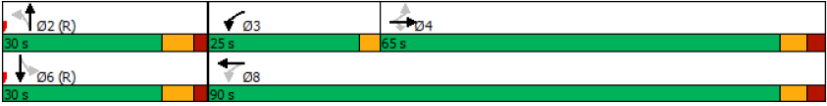
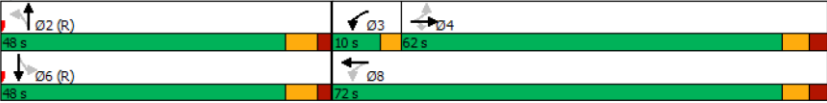
Horizon	Cycle Length (s)	Signal Timing Modifications
Existing Weekday AM	-	-
2028, 2033, & 2043 Weekday AM (New)	120	
Existing Weekday PM	-	-
2028, 2033, & 2043 Weekday PM (New)	120	

The intersection capacity analysis at Humber Station Road & Healey Road under the 2028, 2033, and 2043 horizon years are summarized in **Table 7-20**, **Table 7-21**, **Table 7-22**, respectively, for the weekday AM and PM peak hours.

Table 7-20: Intersection Capacity Analysis, Humber Station Road & Healey Road (2028)

AM	Existing Conditions (2023)				Future Background (2028)				Future Total (2028)			
Mvmt	Vol	V/C	Delay (LOS)	Queue 50th (95th)	Vol	V/C	Delay (LOS)	Queue 50th (95th)	Vol	V/C	Delay (LOS)	Queue 50th (95th)
Overall					-	0.57	31 (C)	-	-	0.62	31 (C)	-
EBL					4	0.01	20 (C)	1 (3)	4	0.01	20 (C)	1 (3)
EBT					618	0.86	42 (D)	145 (177)	618	0.86	42 (D)	145 (176)
EBR					35	0.03	21 (C)	0 (3)	83	0.09	21 (C)	4 (13)
WBL					73	0.40	23 (C)	9 (14)	149	0.65	27 (C)	17 (29)
WBTR					269	0.31	18 (B)	39 (49)	269	0.29	15 (B)	36 (45)
NBL					23	0.07	19 (B)	5 (12)	44	0.15	26 (C)	8 (20)
NBTR					52	0.05	15 (B)	4 (15)	81	0.08	23 (C)	2 (17)
SBL					79	0.17	25 (C)	14 (30)	79	0.20	28 (C)	15 (31)
SBTR					179	0.27	26 (C)	33 (59)	191	0.32	30 (C)	38 (65)
PM	Existing Conditions (2023)				Future Background (2028)				Future Total (2028)			
Mvmt	Vol	V/C	Delay (LOS)	Queue 50th (95th)	Vol	V/C	Delay (LOS)	Queue 50th (95th)	Vol	V/C	Delay (LOS)	Queue 50th (95th)
Overall					-	0.60	25 (C)	-	-	0.66	27 (C)	-
EBL					21	0.17	25 (C)	4 (9)	21	0.18	26 (C)	4 (9)
EBT					308	0.44	28 (C)	61 (75)	308	0.46	29 (C)	61 (75)
EBR					14	0.01	23 (C)	0 (0)	37	0.03	24 (C)	0 (3)
WBL					34	0.10	19 (B)	5 (9)	69	0.21	21 (C)	9 (15)
WBTR					649	0.80	34 (C)	141 (161)	649	0.81	35 (D)	141 (161)
NBL					54	0.11	8 (A)	2 (6)	116	0.23	16 (B)	11 (24)
NBTR					278	0.36	8 (A)	9 (22)	363	0.47	17 (B)	32 (74)
SBL					25	0.06	20 (B)	4 (11)	25	0.08	20 (B)	4 (11)
SBTR					53	0.06	20 (B)	7 (17)	59	0.07	19 (B)	8 (19)

Table 7-21: Intersection Capacity Analysis, Humber Station Road & Healey Road (2033)

AM		Existing Conditions (2023)				Future Background (2033)				Future Total (2033)			
Mvmt	Vol	V/C	Delay (LOS)	Queue 50th (95th)	Vol	V/C	Delay (LOS)	Queue 50th (95th)	Vol	V/C	Delay (LOS)	Queue 50th (95th)	
Overall					-	0.63	31 (C)	-	-	0.85	42 (D)	-	
EBL					4	0.01	18 (B)	1 (2)	4	0.01	18 (B)	1 (3)	
EBT					708	0.90	42 (D)	165 (207)	729	0.93	46 (D)	170 (250)	
EBR					35	0.03	18 (B)	0 (3)	165	0.22	20 (B)	16 (30)	
WBL					73	0.46	24 (C)	8 (13)	287	0.94	73 (E)	56 (106)	
WBTR					324	0.35	16 (B)	44 (56)	333	0.30	9 (A)	31 (44)	
NBL					23	0.08	20 (C)	5 (12)	83	0.52	52 (D)	21 (30)	
NBTR					58	0.06	15 (B)	6 (17)	190	0.19	44 (D)	7 (15)	
SBL					79	0.19	28 (C)	15 (31)	83	0.42	45 (D)	20 (38)	
SBTR					187	0.31	30 (C)	38 (63)	217	0.53	45 (D)	53 (82)	
PM		Existing Conditions (2023)				Future Background (2033)				Future Total (2033)			
Mvmt	Vol	V/C	Delay (LOS)	Queue 50th (95th)	Vol	V/C	Delay (LOS)	Queue 50th (95th)	Vol	V/C	Delay (LOS)	Queue 50th (95th)	
Overall					-	0.70	32 (C)	-	-	0.89	34 (C)	-	
EBL					21	0.21	21 (C)	3 (10)	21	0.25	24 (C)	3 (11)	
EBT					352	0.44	23 (C)	63 (85)	363	0.48	26 (C)	64 (88)	
EBR					14	0.01	19 (B)	0 (0)	80	0.09	21 (C)	3 (12)	
WBL					34	0.09	16 (B)	4 (8)	180	0.52	21 (C)	22 (34)	
WBTR					778	0.86	34 (C)	164 (212)	800	0.89	37 (D)	169 (224)	
NBL					54	0.13	37 (D)	9 (17)	209	0.49	31 (C)	45 (59)	
NBTR					307	0.45	41 (D)	51 (82)	538	0.83	45 (D)	120 (170)	
SBL					25	0.08	24 (C)	4 (11)	27	0.21	28 (C)	5 (14)	
SBTR					55	0.08	24 (C)	8 (19)	69	0.10	24 (C)	11 (22)	

Table 7-22: Intersection Capacity Analysis, Humber Station Road & Healey Road (2043)

AM		Existing Conditions (2023)				Future Background (2043)				Future Total (2043)			
Mvmt	Vol	V/C	Delay (LOS)	Queue 50th (95th)	Vol	V/C	Delay (LOS)	Queue 50th (95th)	Vol	V/C	Delay (LOS)	Queue 50th (95th)	
Overall					-	0.79	27 (C)	-	-	0.94	45 (D)	-	
EBL					4	0.01	9 (A)	0 (2)	4	0.01	13 (B)	0 (3)	
EBT					943	0.88	27 (C)	203 (323)	962	1.02	61 (E)	272 (382)	
EBR					35	0.03	9 (A)	0 (2)	163	0.19	14 (B)	13 (30)	
WBL					73	0.42	38 (D)	4 (13)	184	0.78	64 (E)	33 (55)	
WBTR					473	0.39	6 (A)	29 (54)	483	0.40	6 (A)	29 (50)	
NBL					23	0.19	48 (D)	6 (17)	83	0.81	87 (F)	17 (49)	
NBTR					70	0.11	61 (E)	12 (26)	160	0.18	39 (D)	3 (22)	
SBL					78	0.35	46 (D)	18 (34)	82	0.47	51 (D)	20 (37)	
SBTR					207	0.62	53 (D)	51 (78)	237	0.71	56 (E)	59 (90)	
PM		Existing Conditions (2023)				Future Background (2043)				Future Total (2043)			
Mvmt	Vol	V/C	Delay (LOS)	Queue 50th (95th)	Vol	V/C	Delay (LOS)	Queue 50th (95th)	Vol	V/C	Delay (LOS)	Queue 50th (95th)	

Overall		-	0.97	57 (E)	-	-	1.07	62 (E)	-
EBL		21	0.37	23 (C)	4 (16)	21	0.37	25 (C)	4 (14)
EBT		468	0.52	21 (C)	85 (119)	478	0.58	25 (C)	88 (123)
EBR		14	0.01	15 (B)	0 (0)	79	0.08	18 (B)	3 (12)
WBL		34	0.10	7 (A)	2 (2)	128	0.40	9 (A)	8 (8)
WBTR		1130	1.13	78 (E)	339 (332)	1152	1.18	101 (F)	351 (297)
NBL		54	0.14	37 (D)	14 (27)	208	0.56	37 (D)	52 (75)
NBTR		376	0.63	52 (D)	97 (130)	481	0.81	48 (D)	121 (165)
SBL		26	0.14	30 (C)	5 (12)	28	0.24	33 (C)	5 (14)
SBTR		59	0.10	28 (C)	9 (20)	74	0.12	27 (C)	12 (24)

Future Background Conditions: With signalization, the intersection operates within capacity, with acceptable delays and an overall LOS of 'D' during both peak hours and under all horizons. The exception is the PM peak hour under the 2043 horizon which is expected to operate with an overall v/c ratio greater than 0.90. Notably, the WBTR movement is expected to operate with capacity constraints. It should be noted that this constraint occurs as a result of background traffic and growth.

Future Total Conditions: Increases in delay and v/c ratio are expected under futural total conditions compared to future background conditions during both peak hours and under all horizons. No capacity constraints have been identified under the 2028 and 2033 horizons. However, despite signalization, the intersection is expected to approach capacity during the AM peak hour and operate overcapacity during the PM peak hour under the 2043 horizon. Notably, the EBT movement during the AM peak hour and WBTR movement during the PM peak hour are expected to operate with v/c ratios greater than 1. While we recognize both movements experience worsened operations with site traffic, the subject lands contribute proportionally less trips to the network in comparison to background development and growth traffic. (i.e., 19 site-generated trips vs. 382 background generated trips to the EBT movement and 22 site-generated trips vs. 561 background generated trips to the WBTR movement). Despite capacity constraints, both movements can sufficiently progress through the intersection within 1 cycle length. Overall, this intersection is expected to operate sufficiently.

7.2.2 Triangle Lands Access & Mayfield Road

It was assumed that access to the Triangle Lands background development would occur off Mayfield Road. The intersection is recommended as an unsignalized intersection under the 2028 and 2033 horizon years (see **Section 7.4.1**). However, in order to improve traffic conditions and accommodate future traffic growth at the intersection, signalization is recommended by the 2043 horizon year. The signal timing plan applied under future conditions for this intersection is summarized in **Table 7-23**.

Table 7-23: Recommended Signal Timing Plan, Triangle Lands Access & Mayfield Road

Horizon	Cycle Length (s)	Signal Timing
Existing, 2028, & 2033 Weekday AM	-	-
2043 Weekday AM (New)	190	
Existing, 2028, & 2033 Weekday PM	-	-

2043 Weekday PM (New)	120	
-----------------------	-----	--

The intersection capacity analysis at Triangle Lands Access & Mayfield Road under the 2043 horizon year is summarized in **Table 7-24** for the weekday AM and PM peak hours.

Table 7-24: Intersection Capacity Analysis, Triangle Lands Access & Mayfield Road (2043)

AM	Existing Conditions (2023)				Future Background (2043)				Future Total (2043)			
Mvmt	Vol	V/C	Delay (LOS)	Queue 50th (95th)	Vol	V/C	Delay (LOS)	Queue 50th (95th)	Vol	V/C	Delay (LOS)	Queue 50th (95th)
Overall					-	0.42	6 (A)	-	-	0.46	6 (A)	-
EBL					160	0.43	7 (A)	11 (23)	160	0.47	8 (A)	12 (26)
EBT					1174	0.27	3 (A)	25 (30)	1299	0.30	3 (A)	28 (34)
WBTR					1051	0.24	2 (A)	21 (25)	1137	0.26	3 (A)	23 (28)
SBL					33	0.34	87 (F)	13 (27)	33	0.34	87 (F)	13 (27)
SBR					72	0.05	84 (F)	0 (19)	72	0.05	84 (F)	0 (19)
PM	Existing Conditions (2023)				Future Background (2043)				Future Total (2043)			
Mvmt	Vol	V/C	Delay (LOS)	Queue 50th (95th)	Vol	V/C	Delay (LOS)	Queue 50th (95th)	Vol	V/C	Delay (LOS)	Queue 50th (95th)
Overall					-	0.34	6 (A)	-	-	0.43	7 (A)	-
EBL					85	0.32	4 (A)	0 (6)	85	0.39	7 (A)	1 (12)
EBT					1282	0.31	1 (A)	2 (3)	1363	0.34	1 (A)	3 (4)
WBTR					1242	0.30	3 (A)	21 (38)	1402	0.35	4 (A)	29 (50)
SBL					75	0.48	53 (D)	18 (32)	75	0.42	51 (D)	18 (31)
SBR					167	0.54	55 (D)	15 (37)	167	0.64	59 (E)	23 (44)



Future Background Conditions: With signalization, the intersection is expected to operate well within capacity and with acceptably delays during both peak hours. No constraints have been identified.

Future Total Conditions: Negligible increases in delay and v/c ratio are expected under futural total conditions compared to future background conditions during both weekday peak hours. While the SBL and SBR movements are expected to operate with a LOS of 'F' during the AM peak hour, both movements operate well within capacity. No new constraints have been identified as a result of site traffic.

7.2.3 Arterial A2 & Mayfield Road

As per the *Peel Region Long Range Transportation Plan (2019)*, a new 6-lane road connection is planned between Humber Station Road and Coleraine Drive, extending from Mayfield Road to Highway 50 by the 2043 horizon. The applied signal timing plans to reflect the new road connection and widening along Mayfield Road is summarized in **Table 7-25**. Of note, the lane configuration at A2 Arterial & Mayfield Road was based on Highway 427 Industrial Secondary Plan - Part A MCEA dated October 2022. The eastbound configuration was modified from double right turn lanes as per the MCEA study to a single right turn lane to better accommodate traffic along Mayfield Road.

Table 7-25: Recommended Signal Timing Plan, Arterial A2 & Mayfield Road

Horizon	Cycle Length (s)	Signal Timing
Existing, 2028, & 2033 Weekday AM	-	-
2043 Weekday AM (New)	120	
Existing, 2028, & 2033 Weekday PM	-	-
2043 Weekday PM (New)	120	

The intersection capacity analysis at A2 Arterial & Mayfield Road under the 2043 horizon year is summarized in **Table 7-26** for the weekday AM and PM peak hours.

Table 7-26: Intersection Capacity Analysis, Arterial A2 & Mayfield Road (2043)

AM	Existing Conditions (2023)				Future Background (2043)				Future Total (2043)			
Mvmt	Vol	V/C	Delay (LOS)	Queue 50th (95th)	Vol	V/C	Delay (LOS)	Queue 50th (95th)	Vol	V/C	Delay (LOS)	Queue 50th (95th)
Overall	-				-	0.69	24 (C)	-	-	0.88	27 (C)	-
EBT					1213	0.33	1 (A)	14 (2)	1310	0.37	1 (A)	2 (5)
EBR					808	0.56	77 (E)	118 (220)	841	0.58	77 (E)	37 (61)
WBL					212	0.74	20 (B)	20 (91)	226	0.93	51 (D)	37 (49)
WBT					813	0.23	2 (A)	14 (20)	885	0.26	3 (A)	17 (25)
NBL					10	0.08	54 (D)	1 (9)	84	0.46	54 (D)	14 (25)
NBR					121	0.05	54 (D)	0 (16)	149	0.25	52 (D)	6 (23)
PM	Existing Conditions (2023)				Future Background (2043)				Future Total (2043)			
Mvmt	Vol	V/C	Delay (LOS)	Queue 50th (95th)	Vol	V/C	Delay (LOS)	Queue 50th (95th)	Vol	V/C	Delay (LOS)	Queue 50th (95th)
Overall	-				-	0.57	16 (B)	-	-	0.63	19 (B)	-
EBT					1129	0.50	10 (A)	23 (27)	1197	0.60	15 (B)	86 (92)
EBR					215	0.16	1 (A)	0 (2)	297	0.23	11 (B)	3 (2)
WBL					215	0.51	10 (A)	15 (32)	251	0.56	15 (B)	23 (57)
WBT					1163	0.37	8 (A)	41 (59)	1287	0.42	9 (A)	50 (71)
NBL					426	0.74	50 (D)	56 (70)	464	0.76	50 (D)	61 (75)
NBR					238	0.31	42 (D)	11 (36)	251	0.38	42 (D)	17 (44)

Future Background Conditions: The intersection is expected to operate well within capacity and with acceptably delays during both peak hours. While the EBR movement is expected to operate with a LOS of 'F' during the AM peak hour, the movement 'F' operates well within capacity. No constraints have been identified.

Future Total Conditions: Minor increases in delay and v/c ratio are expected under futural total conditions compared to future background conditions during both weekday peak hours. No new constraints have been identified as a result of site traffic.

7.2.4 Humber Station Road & George Bolton Parkway (Subject Lands Site Access 1)

Of note, the future intersection of George Bolton Parkway & Humber Station Road is proposed as a full-movements unsignalized intersection in the 2028 horizon (see **Section 7.4.2**) and as a signalized intersection by 2033. The recommended signal timing plan under future conditions is summarized in **Table 7-27**. As previously mentioned, the 2028 and 2033 horizon years include the partial buildout of George Bolton Parkway to facilitate access for the subject lands. Ultimate 2043 conditions include the full western extension of George Bolton Parkway, connecting Coleraine Drive to Humber Station Road.

Table 7-27: Recommended Signal Timing Plan, Humber Station Road & George Bolton Parkway (Subject Lands Site Access 1)

Horizon	Cycle Length (s)	Signal Timing
Existing & 2028 Weekday AM	-	-
2033 & 2043 Weekday AM (New)	-	
Existing & 2028 Weekday PM	-	-
2033 & 2043 Weekday PM (New)	-	

The intersection capacity analysis at Humber Station Road & George Bolton Parkway (Subject Lands Access 1) under the 2033 and 2043 horizon years are summarized in **Table 7-28** and **Table 7-29**, respectively, for the weekday AM and PM peak hours.

Table 7-28: Intersection Capacity Analysis, Humber Station Road & George Bolton Parkway (Subject Lands Site Access 1) (2033)

AM	Existing Conditions (2023)				Future Background (2033)				Future Total (2033)			
	Mvmt	Vol	V/C	Delay (LOS)	Queue 50th (95th)	Vol	V/C	Delay (LOS)	Queue 50th (95th)	Vol	V/C	Delay (LOS)
Overall									-	0.46	16 (B)	-
WBL									179	0.73	58 (E)	43 (64)
WBR									110	0.08	42 (D)	0 (15)
NBT									251	0.20	5 (A)	12 (25)
NBR									505	0.36	5 (A)	0 (0)
SBL									285	0.40	14 (B)	49 (81)
SBT									372	0.29	11 (B)	54 (89)
PM	Existing Conditions (2023)				Future Background (2033)				Future Total (2033)			
Mvmt	Vol	V/C	Delay (LOS)	Queue 50th (95th)	Vol	V/C	Delay (LOS)	Queue 50th (95th)	Vol	V/C	Delay (LOS)	Queue 50th (95th)
Overall									-	0.64	27 (C)	-

WBL			475	0.88	51 (D)	107 (140)
WBR			292	0.22	27 (C)	0 (17)
NBT			445	0.48	17 (B)	45 (88)
NBR			251	0.28	15 (B)	7 (10)
SBL			140	0.44	20 (B)	22 (48)
SBT			240	0.27	14 (B)	22 (55)

Table 7-29: Intersection Capacity Analysis, Humber Station Road & George Bolton Parkway (Subject Lands Site Access 1) (2043)

AM	Existing Conditions (2023)				Future Background (2043)				Future Total (2043)			
Mvmt	Vol	V/C	Delay (LOS)	Queue 50th (95th)	Vol	V/C	Delay (LOS)	Queue 50th (95th)	Vol	V/C	Delay (LOS)	Queue 50th (95th)
Overall									-	0.33	9 (A)	-
WBL									106	0.59	54 (D)	25 (43)
WBR									61	0.05	46 (D)	0 (12)
NBT									271	0.20	3 (A)	6 (15)
NBR									324	0.23	3 (A)	0 (1)
SBL									181	0.24	3 (A)	5 (12)
SBT									400	0.29	3 (A)	11 (24)
PM	Existing Conditions (2023)				Future Background (2043)				Future Total (2043)			
Mvmt	Vol	V/C	Delay (LOS)	Queue 50th (95th)	Vol	V/C	Delay (LOS)	Queue 50th (95th)	Vol	V/C	Delay (LOS)	Queue 50th (95th)
Overall									-	0.54	19 (B)	-
WBL									284	0.79	54 (D)	66 (89)
WBR									161	0.12	36 (D)	0 (16)
NBT									515	0.45	5 (A)	18 (49)
NBR									162	0.16	1 (A)	0 (2)
SBL									89	0.23	10 (B)	10 (19)
SBT									246	0.22	10 (A)	26 (42)

Future Total Conditions: With signalization, the intersection is expected to operate well within capacity and with acceptably delays during both peak hours and under both the 2033 and 2043 horizon years. No constraints have been identified.

7.2.5 Subject Lands Site Access 4 & Healey Road

Of note, access to the subject lands off Healey Road is proposed under Phase 2 of the development to facilitate access for full buildout of the subject lands. The intersection is recommended as an unsignalized intersection under the 2033 horizon year (see **Section 7.4.3**). However, in order to improve traffic conditions and accommodate future traffic growth at the intersection, signalization is recommended by the 2043 horizon year. The signal timing plan applied under future conditions for this intersection is summarized in **Table 7-30**.

Table 7-30: Recommended Signal Timing Plan, Subject Lands Site Access 4 & Healey Road

Horizon	Cycle Length (s)	Signal Timing
Existing, 2028, & 2033 Weekday AM	-	-
2043 Weekday AM (New)		
Existing, 2028, & 2033 Weekday PM	-	-
2043 Weekday PM (New)		

The intersection capacity analysis at Subject Lands Site Access 4 & Healey Road under the 2043 horizon year is summarized in **Table 7-31** for the weekday AM and PM peak hours.

Table 7-31: Intersection Capacity Analysis, Subject Lands Site Access 4 & Healey Road (2043)

AM	Existing Conditions (2023)				Future Background (2043)				Future Total (2043)			
Mvmt	Vol	V/C	Delay (LOS)	Queue 50th (95th)	Vol	V/C	Delay (LOS)	Queue 50th (95th)	Vol	V/C	Delay (LOS)	Queue 50th (95th)
Overall									-	0.75	6 (A)	-
EBT									1180	0.78	6 (A)	7 (32)
WBL									67	0.29	5 (A)	1 (8)
WBT									635	0.41	3 (A)	9 (62)
NBL									32	0.36	57 (E)	8 (18)
NBR									27	0.02	53 (D)	0 (9)
PM	Existing Conditions (2023)				Future Background (2043)				Future Total (2043)			
Mvmt	Vol	V/C	Delay (LOS)	Queue 50th (95th)	Vol	V/C	Delay (LOS)	Queue 50th (95th)	Vol	V/C	Delay (LOS)	Queue 50th (95th)
Overall									-	0.75	7 (A)	-
EBT									708	0.46	6 (A)	56 (100)
WBL									35	0.07	0 (A)	0 (0)
WBT									1208	0.77	2 (A)	11 (3)
NBL									72	0.60	61 (E)	17 (32)
NBR									64	0.05	51 (D)	0 (13)

Future Total Conditions: With signalization, the intersection is expected to operate well within capacity and with acceptably delays during both peak hours. No constraints have been identified.

7.3 EXISTING UNSIGNALIZED INTERSECTIONS

The results for the studied existing unsignalized intersections under each traffic scenario during the weekday AM and PM peak hours are summarized in the sections below.

7.3.1 Humber Station Road & Healey Road

As previously mentioned, signalization of Humber Station Road & Healey Road is recommended in 2028. As such, only the existing intersection operations are provided below in **Table 7-32** for the weekday AM and PM peak hours.

Table 7-32: Intersection Capacity Analysis, Humber Station Road & Healey Road (Existing)

AM		Existing Conditions (2023)			
Mvmt	Vol	V/C	Delay (LOS)	Queue 95th	
EBLTR	522	0.87	34 (D)	-	
WBLTR	287	0.51	15 (C)	-	
NBLTR	53	0.11	11 (B)	-	
SBLTR	238	0.46	15 (C)	-	
PM		Existing Conditions (2023)			
Mvmt	Vol	V/C	Delay (LOS)	Queue 95th	
EBLTR	274	0.48	15 (B)	-	
WBLTR	552	0.89	38 (E)	-	
NBLTR	268	0.49	16 (C)	-	
SBLTR	70	0.14	11 (B)	-	

Existing Conditions: All movements at the unsignalized intersection operate within capacity and with acceptable delays during both weekday AM and PM peak hours. No critical movements have been identified.

7.4 FUTURE UNSIGNALIZED INTERSECTIONS

The results for the studied future unsignalized intersections under each traffic scenario during the weekday AM and PM peak hours are summarized in the sections below.

7.4.1 Triangle Lands Access & Mayfield Road

As previously mentioned, it was assumed that access to the Triangle Lands background development would occur off Mayfield Road. Of note, signalization at Triangle Lands Access & Mayfield Road is recommended by the 2043 horizon (see **Section 7.2.2**). As such, only the 2028 and 2033 horizon year intersection operations are provided below in **Table 7-33** and **Table 7-34**, respectively, for the weekday AM and PM peak hours.

Table 7-33: Intersection Capacity Analysis, Triangle Lands Access & Mayfield Road (2028)

AM		Existing Conditions (2023)				Future Background (2028)				Future Total (2028)			
Mvmt	Vol	V/C	Delay (LOS)	Queue 50th (95th)	Vol	V/C	Delay (LOS)	Queue 50th (95th)	Vol	V/C	Delay (LOS)	Queue 50th (95th)	
EBL					160	0.18	10 (A)	5	160	0.18	10 (A)	5	
EBT					408	0.24	0 (A)	0	413	0.24	0 (A)	0	
WBT					412	0.24	0 (A)	0	440	0.26	0 (A)	0	
WBTR					314	0.18	0 (A)	0	328	0.19	0 (A)	0	
SBL					33	0.11	19 (C)	3	33	0.31	54 (F)	10	
SBR					72	0.09	10 (B)	3	72	0.09	10 (B)	2	
PM		Existing Conditions (2023)				Future Background (2028)				Future Total (2028)			

Mvmt	Vol	V/C	Delay (LOS)	Queue 50th (95th)	Vol	V/C	Delay (LOS)	Queue 50th (95th)	Vol	V/C	Delay (LOS)	Queue 50th (95th)
EBL					85	0.11	10 (B)	3	85	0.11	10 (B)	3
EBT					388	0.23	0 (A)	0	405	0.24	0 (A)	0
WBT					559	0.33	0 (A)	0	572	0.34	0 (A)	0
WBTR					336	0.20	0 (A)	0	343	0.20	0 (A)	0
SBL					75	0.24	20 (C)	7	75	0.68	88 (F)	28
SBR					167	0.23	12 (B)	7	167	0.23	11 (B)	7

Table 7-34: Intersection Capacity Analysis, Triangle Lands Access & Mayfield Road (2033)

AM	Existing Conditions (2023)				Future Background (2033)				Future Total (2033)			
Mvmt	Vol	V/C	Delay (LOS)	Queue 50th (95th)	Vol	V/C	Delay (LOS)	Queue 50th (95th)	Vol	V/C	Delay (LOS)	Queue 50th (95th)
EBL					160	0.18	10 (A)	5	160	0.19	10 (B)	6
EBT					462	0.27	0 (A)	0	493	0.29	0 (A)	0
WBT					449	0.26	0 (A)	0	533	0.31	0 (A)	0
WBTR					333	0.20	0 (A)	0	375	0.22	0 (A)	0
SBL					33	0.34	61 (F)	11	33	0.42	80 (F)	13
SBR					72	0.09	10 (A)	2	72	0.08	9 (A)	2
PM	Existing Conditions (2023)				Future Background (2033)				Future Total (2033)			
Mvmt	Vol	V/C	Delay (LOS)	Queue 50th (95th)	Vol	V/C	Delay (LOS)	Queue 50th (95th)	Vol	V/C	Delay (LOS)	Queue 50th (95th)
EBL					85	0.12	11 (B)	3	85	0.12	11 (B)	3
EBT					442	0.26	0 (A)	0	496	0.29	0 (A)	0
WBT					610	0.36	0 (A)	0	663	0.39	0 (A)	0
WBTR					362	0.21	0 (A)	0	389	0.23	0 (A)	0
SBL					75	0.77	116 (F)	33	75	0.95	178 (F)	40
SBR					167	0.23	11 (B)	7	167	0.22	11 (B)	7

Future Background Conditions: The intersection is expected to operate well within capacity and with acceptably delays during both peak hours. No constraints have been identified.

Future Total Conditions: Negligible increases in delay and v/c ratio are expected under futural total conditions compared to future background conditions during both weekday peak hours. While the SBL movement is expected to operate with a LOS of 'F' during the AM and PM peak hours, the movement operates well within capacity. No constraints have been identified as a result of site traffic.

7.4.2 Humber Station Road & George Bolton Parkway (Subject Lands Site Access 1)

As previously mentioned, the 2028 and 2033 horizon years include the partial buildout of George Bolton Parkway to facilitate access for the subject lands. Ultimate 2043 conditions include the full western extension of George Bolton Parkway, connecting Coleraine Drive to Humber Station Road. Of note, signalization of Humber Station Road & George Bolton Parkway is recommended by the 2033 horizon (see **Section 7.2.4**). As such, only the 2028 horizon year intersection operations are provided below in **Table 7-35** for the weekday AM and PM peak hours.

Table 7-35: Intersection Capacity Analysis, Humber Station Road & George Bolton Parkway (Subject Lands Site Access 1) (2028)

AM	Existing Conditions (2023)				Future Background (2028)				Future Total (2028)			
Mvmt	Vol	V/C	Delay (LOS)	Queue 50th (95th)	Vol	V/C	Delay (LOS)	Queue 50th (95th)	Vol	V/C	Delay (LOS)	Queue 50th (95th)
WBL	-				-				81	0.22	18 (C)	7
WBR									50	0.05	9 (A)	1
NBT									81	0.05	0 (A)	0
NBR									243	0.14	0 (A)	0
SBL									136	0.11	8 (A)	3
SBT									290	0.17	0 (A)	0
PM	Existing Conditions (2023)				Future Background (2028)				Future Total (2028)			
Mvmt	Vol	V/C	Delay (LOS)	Queue 50th (95th)	Vol	V/C	Delay (LOS)	Queue 50th (95th)	Vol	V/C	Delay (LOS)	Queue 50th (95th)
WBL	-				-				239	0.52	21 (C)	24
WBR									147	0.21	12 (B)	6
NBT									322	0.19	0 (A)	0
NBR									113	0.07	0 (A)	0
SBL									64	0.06	9 (A)	2
SBT									88	0.05	0 (A)	0

Future Total Conditions: The intersection is expected to operate well within capacity and with acceptably delays during both peak hours. No constraints have been identified.

7.4.3 Subject Lands Site Access 2 & Humber Station Road

As previously noted, local road connections off Humber Station Road is proposed under Phase 2 of the development to facilitate access for full buildout of the subject lands. As such, only the 2033 and 2043 horizon year intersection operations are provided below in **Table 7-36** and **Table 7-37**, respectively, for the weekday AM and PM peak hours

Table 7-36: Intersection Capacity Analysis, Subject Lands Site Access 2 & Humber Station Road (2033)

AM	Existing Conditions (2023)				Future Background (2033)				Future Total (2033)			
Mvmt	Vol	V/C	Delay (LOS)	Queue 50th (95th)	Vol	V/C	Delay (LOS)	Queue 50th (95th)	Vol	V/C	Delay (LOS)	Queue 50th (95th)
WBL	-				-				3	0.01	21 (C)	0
WBR									2	0.00	10 (B)	0
NBT									352	0.21	0 (A)	0
NBR									9	0.01	0 (A)	0
SBL									4	0.00	8 (A)	0
SBT									654	0.38	0 (A)	0
PM	Existing Conditions (2023)				Future Background (2033)				Future Total (2033)			
Mvmt	Vol	V/C	Delay (LOS)	Queue 50th (95th)	Vol	V/C	Delay (LOS)	Queue 50th (95th)	Vol	V/C	Delay (LOS)	Queue 50th (95th)
WBL	-				-				7	0.03	22 (C)	1

WBR			5	0.01	14 (B)	0
NBT			732	0.43	0 (A)	0
NBR			5	0.00	0 (A)	0
SBL			2	0.00	9 (A)	0
SBT			373	0.22	0 (A)	0

Table 7-37: Intersection Capacity Analysis, Subject Lands Site Access 2 & Humber Station Road (2043)

AM		Existing Conditions (2023)				Future Background (2043)				Future Total (2043)			
Mvmt	Vol	V/C	Delay (LOS)	Queue 50th (95th)	Vol	V/C	Delay (LOS)	Queue 50th (95th)	Vol	V/C	Delay (LOS)	Queue 50th (95th)	
WBL									3	0.01	19 (C)	0	
WBR									2	0.00	10 (A)	0	
NBT									323	0.19	0 (A)	0	
NBR									9	0.01	0 (A)	0	
SBL									4	0.00	8 (A)	0	
SBT									578	0.34	0 (A)	0	
PM		Existing Conditions (2023)				Future Background (2043)				Future Total (2043)			
Mvmt	Vol	V/C	Delay (LOS)	Queue 50th (95th)	Vol	V/C	Delay (LOS)	Queue 50th (95th)	Vol	V/C	Delay (LOS)	Queue 50th (95th)	
WBL									7	0.03	20 (C)	1	
WBR									5	0.01	14 (B)	0	
NBT									671	0.39	0 (A)	0	
NBR									5	0.00	0 (A)	0	
SBL									2	0.00	9 (A)	0	
SBT									328	0.19	0 (A)	0	

Future Total Conditions: The intersection is expected to operate well within capacity and with acceptably delays during both peak hours and under both horizon years. No constraints have been identified.

7.4.4 Subject Lands Site Access 3 & Humber Station Road

As previously noted, local road connections off Humber Station Road is proposed under Phase 2 of the development to facilitate access for full buildout of the subject lands. As such, only the 2033 and 2043 horizon year intersection operations are provided below in **Table 7-38** and **Table 7-39**, respectively, for the weekday AM and PM peak hours

Table 7-38: Intersection Capacity Analysis, Subject Lands Site Access 3 & Humber Station Road (2033)

AM		Existing Conditions (2023)				Future Background (2033)				Future Total (2033)			
Mvmt	Vol	V/C	Delay (LOS)	Queue 50th (95th)	Vol	V/C	Delay (LOS)	Queue 50th (95th)	Vol	V/C	Delay (LOS)	Queue 50th (95th)	
WBL									38	0.15	22 (C)	4	
WBR									24	0.03	10 (A)	1	
NBT									254	0.15	0 (A)	0	
NBR									100	0.06	0 (A)	0	
SBL									57	0.05	8 (A)	1	

SBT										620	0.36	0 (A)	0
PM		Existing Conditions (2023)				Future Background (2033)				Future Total (2033)			
Mvmt	Vol	V/C	Delay (LOS)	Queue 50th (95th)	Vol	V/C	Delay (LOS)	Queue 50th (95th)	Vol	V/C	Delay (LOS)	Queue 50th (95th)	
WBL									88	0.37	29 (D)	13	
WBR									54	0.13	15 (B)	3	
NBT									683	0.40	0 (A)	0	
NBR									54	0.03	0 (A)	0	
SBL									30	0.04	10 (A)	1	
SBT									287	0.17	0 (A)	0	

Table 7-39: Intersection Capacity Analysis, Subject Lands Site Access 3 & Humber Station Road (2043)

AM		Existing Conditions (2023)				Future Background (2043)				Future Total (2043)			
Mvmt	Vol	V/C	Delay (LOS)	Queue 50th (95th)	Vol	V/C	Delay (LOS)	Queue 50th (95th)	Vol	V/C	Delay (LOS)	Queue 50th (95th)	
WBL									38	0.13	19 (C)	4	
WBR									24	0.03	10 (A)	1	
NBT									225	0.13	0 (A)	0	
NBR									100	0.06	0 (A)	0	
SBL									57	0.05	8 (A)	1	
SBT									544	0.32	0 (A)	0	
PM		Existing Conditions (2023)				Future Background (2043)				Future Total (2043)			
Mvmt	Vol	V/C	Delay (LOS)	Queue 50th (95th)	Vol	V/C	Delay (LOS)	Queue 50th (95th)	Vol	V/C	Delay (LOS)	Queue 50th (95th)	
WBL									88	0.32	24 (C)	11	
WBR									54	0.12	14 (B)	3	
NBT									622	0.37	0 (A)	0	
NBR									54	0.03	0 (A)	0	
SBL									30	0.03	9 (A)	1	
SBT									242	0.14	0 (A)	0	

Future Total Conditions: The intersection is expected to operate well within capacity and with acceptably delays during both peak hours and under both horizon years. No constraints have been identified.

7.4.5 Subject Lands Site Access 4 & Healey Road

As previously noted, access to the subject lands off Healey Road is proposed under Phase 2 of the development to facilitate access for full buildout of the subject lands. Signalization of the Subject Lands Site Access & Healey Road is recommended by the 2043 horizon (see **Section 7.2.5**). As such, only the 2033 horizon year intersection operations are provided below in **Table 7-40** for the weekday AM and PM peak hours

Table 7-40: Intersection Capacity Analysis, Subject Lands Site Access 4 & Healey Road (2033)

AM	Existing Conditions (2023)				Future Background (2033)				Future Total (2033)			
Mvmt	Vol	V/C	Delay (LOS)	Queue 50th (95th)	Vol	V/C	Delay (LOS)	Queue 50th (95th)	Vol	V/C	Delay (LOS)	Queue 50th (95th)
EBTR	-				-				982	0.58	0 (A)	0
WBTL									72	0.11	3 (A)	3
NBL									32	0.36	67 (F)	11
NBR									27	0.09	18 (C)	2
PM	Existing Conditions (2023)				Future Background (2033)				Future Total (2033)			
Mvmt	Vol	V/C	Delay (LOS)	Queue 50th (95th)	Vol	V/C	Delay (LOS)	Queue 50th (95th)	Vol	V/C	Delay (LOS)	Queue 50th (95th)
EBTR	-				-				700	0.41	0 (A)	0
WBTL									38	0.04	1 (A)	1
NBL									73	0.77	116 (F)	32
NBR									63	0.15	15 (B)	4

Future Total Conditions: The intersection is expected to operate well within capacity and with acceptably delays during both peak hours. While the NBL movement is expected to operate with a LOS of 'F' during the PM peak hour, the movement operates with residual capacity. No constraints have been identified.

7.4.6 Subject Lands Site Access 5 & Mayfield Road

As previously noted, a local road connection off Mayfield Road is proposed under Phase 2 of the development to facilitate access for full buildout of the subject lands. As such, only the 2033 and 2043 horizon year intersection operations are provided below in **Table 7-41** and **Table 7-42**, respectively, for the weekday AM and PM peak hours.

Table 7-41: Intersection Capacity Analysis, Subject Lands Site Access 5 & Mayfield Road (2033)

AM	Existing Conditions (2023)				Future Background (2033)				Future Total (2033)			
Mvmt	Vol	V/C	Delay (LOS)	Queue 50th (95th)	Vol	V/C	Delay (LOS)	Queue 50th (95th)	Vol	V/C	Delay (LOS)	Queue 50th (95th)
EBL	-				-				25	0.03	10 (A)	1
EBT									570	0.34	0 (A)	0
WBT									573	0.34	0 (A)	0
WBTR									299	0.18	0 (A)	0
SBL									5	0.04	32 (D)	1
SBR									10	0.02	11 (B)	0
PM	Existing Conditions (2023)				Future Background (2033)				Future Total (2033)			
Mvmt	Vol	V/C	Delay (LOS)	Queue 50th (95th)	Vol	V/C	Delay (LOS)	Queue 50th (95th)	Vol	V/C	Delay (LOS)	Queue 50th (95th)
EBL	-				-				14	0.02	11 (B)	1
EBT									532	0.31	0 (A)	0
WBT									771	0.45	0 (A)	0
WBTR									391	0.23	0 (A)	0
SBL									11	0.12	49 (E)	3
SBR									23	0.05	13 (B)	1

Table 7-42: Intersection Capacity Analysis, Subject Lands Site Access 5 & Mayfield Road (2043)

AM		Existing Conditions (2023)				Future Background (2033)				Future Total (2033)			
Mvmt	Vol	V/C	Delay (LOS)	Queue 50th (95th)	Vol	V/C	Delay (LOS)	Queue 50th (95th)	Vol	V/C	Delay (LOS)	Queue 50th (95th)	
EBL									22	0.03	10 (A)	1	
EBT									715	0.42	0 (A)	0	
WBT									382	0.22	0 (A)	0	
WBTR									206	0.12	0 (A)	0	
SBL									6	0.01	13 (B)	0	
SBR									9	0.01	9 (A)	0	
PM		Existing Conditions (2023)				Future Background (2033)				Future Total (2033)			
Mvmt	Vol	V/C	Delay (LOS)	Queue 50th (95th)	Vol	V/C	Delay (LOS)	Queue 50th (95th)	Vol	V/C	Delay (LOS)	Queue 50th (95th)	
EBL									12	0.03	13 (B)	1	
EBT									493	0.29	0 (A)	0	
WBT									697	0.41	0 (A)	0	
WBTR									357	0.21	0 (A)	0	
SBL									14	0.08	27 (D)	2	
SBR									20	0.02	9 (A)	1	

Future Total Conditions: The intersection is expected to operate well within capacity and with acceptably delays during both peak hours and under both horizon years. No constraints have been identified.

7.5 SUMMARY OF INTERSECTION CAPACITY ANALYSIS RESULTS

With signal optimizations, the realignment of the Clarkway Drive/Humber Station Road & Mayfield Road intersection, planned widenings along adjacent regional roads, and other road network infrastructure improvements, the intersection capacity analysis results indicate that site traffic is expected to have an acceptable impact on the surrounding road network. In addition, the proposed site accesses to the subject lands are expected to operate sufficiently under future horizons. A small number of capacity constraints have been identified due to high volumes of background development and growth traffic at study area intersections; however, none are attributed to site traffic. Furthermore, signalization is recommended at Humber Station Road & Healey Road by the 2028 horizon to accommodate future traffic growth, a recommendation which is irrespective of site traffic given that the intersection operates poorly under future background conditions. Overall, the subject lands are expected to have an acceptable impact on the road network operations in the surrounding area. Of note, timing of the planned infrastructure improvements detailed within this section could be advanced to further the development of the ultimate road network.

8 TRANSPORTATION DEMAND MANAGEMENT

A Transportation Demand Management (TDM) Strategy is necessary to ensure successful implementation of initiatives that act to reduce automobile use and increase the use of active and sustainable modes of transportation. The following section provides an overview of what Transportation Demand Management is and how it can be applied to reduce dependency on single occupancy vehicles (SOV) and encourage other methods of travel throughout the study area.

8.1 WHAT IS TDM?

Transportation Demand Management seeks to apply behaviour change tools and incentives to align transport demand with supply. TDM is a toolkit of strategies that facilitates a more efficient transportation network by influencing travel behaviour. Effective implementation of TDM strategies may improve the supply or reduce the demand on a transportation network, resulting in reduced congestion. These strategies provide methods to reduce, re-mode, re-time, and/or re-route trips, also known as the 4 R's of TDM.

8.2 HOW ARE TDM GOALS ACHIEVED?

TDM strategies generally fall into 3 categories:

1. **Land Use and Urban Design Strategies:** Utilizing the streetscape and land use development to support a more efficient transport network by prioritizing efficient modes such as walking, cycling, transit, or carpooling.
2. **Incentive and Disincentive Strategies:** A “carrot and stick” approach to TDM that influences travel choices by making a particular mode or travel choice more attractive (incentive) and/or another mode less attractive (disincentive).
3. **Educational, Promotional, and Outreach Strategies:** Utilizing information and events to improve understanding, raise awareness, and raise positive sentiment to sustainable travel.

The most effective TDM strategy is well-planned, customized, and coordinated, utilizing a comprehensive suite of TDM strategies to target workplaces within the study area.

8.3 TDM BENEFITS

Transportation studies generally have an overall vision for their transportation network in which certain TDM benefits are prioritized and TDM strategies are selected to complement the area vision to the greatest extent possible. Some TDM benefits are as follows:

- Congestion reduction for all users by managing travel demand thus improving the experience for all modes;
- Energy/emission reduction through fewer or more efficient vehicle trips;
- Improving health and fitness by increasing active transportation trips and improving air quality;
- Improving the livability of an area by providing more attractive streetscaping, encouraging livable urban design, and increasing street animation;

- Parking management solutions that reduce the overall developable space dedicated to parking; and
- Improving safety for all users through the design and prioritization of alternative modes.

8.4 POTENTIAL TDM STRATEGIES

It is recommended that developments be required to submit and implement a comprehensive Transportation Demand Management Strategy that demonstrates how the proposed development will support a shift to more sustainable travel modes. The following provides a list of TDM strategies to consider.

Pedestrian-Based Strategies

Development within the Humber Station Employment Area lands should ensure safe, comfortable, and convenient pedestrian connections to key destinations within the surrounding area. Pedestrian strategies to encourage walking as a mode of travel include:

- Orient building entrances close to the street with direction connections to pedestrian pathways
- Provide landscaping and pedestrian amenities such as trees, sidewalks, benches, and marked crossings to create an attractive public realm and encourage walking

Cycling-Based Strategies

Development within the Humber Station Employment Area lands should promote cycling as a convenient travel option. Cycling strategies to encourage biking as a mode of travel include:

- Avoid barriers to cyclists such as curbs or stairs, where possible
- Provide cycling infrastructure and end-of-trip infrastructure such as secure bicycle racks, bicycle storage, and shower and change room facilities
- Provide cyclists with sheltered and secure bicycle storage facilities

Transit-Based Strategies

Development within the Humber Station Employment Area lands should consider connections and access to transit. Transit strategies to encourage transit trips include:

- Provide weather-protected transit stops
- Subsidize transit passes or pre-loaded transit cards for new employees
- Enhance the comfort of outdoor pedestrian waiting areas through year-round planting that provide shelter from the wind in the winter months and shade during the summer months

Travel and Parking Management Strategies

Development within the Humber Station Employment Area lands should increase awareness of sustainable transportation opportunities and avoid an oversupply of parking. Travel and parking strategies to reduce private vehicle trips include:

- Encourage participation in Smart Commute Workplace programs to expand travel opportunities for employees in sustainable ways

- Permit reductions in maximum and minimum parking requirements once TDM measures are adopted as part of a development approval
- Encourage shared parking arrangements between uses to reduce the need for parking spaces within a development
- Provide dedicated and/or preferential, publicly accessible car-share or carpooling parking spaces

9 CONCLUSION

- ▶ This Transportation Mobility Plan has been prepared to support the Secondary Plan study and development of the transportation network in the Humber Station Employment Area lands. The Humber Station Employment Area lands are planned for employment consisting of Prestige Employment and predominately General Employment land use designations and are planned for a minimum density of 26 jobs per hectare to achieve the employment density targets as outlined in the Town's Draft Official Plan (August 2023).
- ▶ The goals and objectives for the Humber Station Employment Area study area are influenced by policy documents at the provincial, regional, and local levels. From a transportation perspective, these documents encourage development of a multimodal network to support the efficient movement of people and goods. Objectives include developing a long-term strategy to accommodate the needs of all road users while enhancing connectivity and accessibility.
- ▶ The Humber Station Employment study area is serviced by Peel Region, Town of Caledon, and City of Brampton roads. There are 3 regional roadways and 4 municipal roadways comprising the arterial, collector, and local road network in the study area.
- ▶ Local transit service for the Bolton area is provided by Voyago while inter-regional commuter bus service is operated by GO Transit between Malton and the area of Highway 50 & Columbia Way. Bike lanes are provided on both sides of George Bolton Parkway, east of Coleraine Drive. However, no cycling facilities are available along the remaining study area roadways. The study area also exhibits poor pedestrian connectivity which can be attributed to the lack of collector/local streets, missing facilities, and discontinuous sidewalks.
- ▶ This assessment considers the 5, 10, and 20-year horizon from the existing year 2023. The future background conditions include traffic added to the network from other future developments, corridor growth, and road network improvements.
- ▶ Full buildout of the subject lands is anticipated to generate 1,430 two-way auto vehicle trips during the AM peak hour (1,065 inbound, 365 outbound) and 1,435 two-way auto vehicle trips during the PM peak hour (479 inbound, 956 outbound). In addition, 148 two-way truck trips (83 inbound, 65 outbound) are anticipated during the AM peak hour and 238 two-way truck trips (103 inbound, 135 outbound) are anticipated during the PM peak hour.
- ▶ A network of collector and/or local roads is required to provide servicing, frontage, and connectivity to the external road network. The initial recommendation for the internal road network under the 2028 horizon includes the partial buildout of George Bolton Parkway to facilitate access for Parcel 1. Under the 2033 horizon year, local connections to Humber Station Road, Healey Road, and Mayfield Road are proposed to accommodate full buildout of the subject lands.
- ▶ The ultimate 2043 conditions include the full western extension of George Bolton Parkway, connecting Coleraine Drive to Humber Station Road. All five site accesses are proposed as unsignalized intersections in the interim. The future intersections of George Bolton Parkway & Humber Station Road and the future local connection off Healey Road are proposed as full-movement signalized intersections under ultimate conditions.

- ▶ The intersection capacity analysis was conducted for the AM and PM peak hours under the existing, future background (2028, 2033, 2043) and future total (2028, 2033, 2043) horizons. With signal optimizations, the realignment of the Clarkway Drive/Humber Station Road & Mayfield Road intersection, planned widenings along adjacent regional roads, and other road network infrastructure improvements, the intersection capacity analysis results indicate that site traffic is expected to have an acceptable impact on the surrounding road network. In addition, the proposed site accesses to the subject lands are expected to operate sufficiently under future horizons.
- ▶ A small number of capacity constraints have been identified due to high volumes of background development and growth traffic at study area intersections; however, none are attributed to site traffic. Furthermore, signalization is recommended at Humber Station Road & Healey Road by the 2028 horizon to accommodate future traffic growth, a recommendation which is irrespective of site traffic given that the intersection operates poorly under future background conditions. Overall, the subject lands are expected to have an acceptable impact on the road network operations in the surrounding area. Of note, timing of the planned infrastructure improvements could be advanced to further the development of the ultimate road network.
- ▶ A list of TDM strategies have been recommended to reduce single-occupant vehicle trips and encourage multi-modal travel alternatives for the subject lands.



APPENDIX A

MMLOS

Exhibit 4 – PLOS Segment Evaluation Table

Sidewalk Width (m)	Boulevard Width (m)	Motor Vehicle Traffic Volume (AADT)	Presence of On-street Parking	Segment PLOS			
				Operating Speed (km/h)			
				≤30	>30 or 50	>50 or 60	>60 ¹
2.0 or more	> 2	≤ 3000	N/A	A	A	A	B
		> 3000	Yes	A	B	B	N/A
			No	A	B	C	D
	0.5 to 2	≤ 3000	N/A	A	A	A	B
		> 3000	Yes	A	B	C	N/A
			No	A	C	D	E
	0	≤ 3000	NA	A	B	C	D
		> 3000	Yes	B	B	D	N/A
			No	B	C	E	F
1.8	> 2	≤ 3000	N/A	A	A	A	B
		> 3000	Yes	A	B	C	N/A
			No	A	C	D	E
	0.5 to 2	≤ 3000	N/A	A	B	B	D
		> 3000	Yes	A	C	C	N/A
			No	B	C	E	E
	0	≤ 3000	N/A	A	B	C	D
		> 3000	Yes	B	C	D	N/A
			No	C	D	F	F
1.5	> 2	≤ 3000	N/A	C	C	C	C
		> 3000	Yes	C	C	D	N/A
			No	C	D	E	E
	0.5 to 2	≤ 3000	N/A	C	C	C	D
		> 3000	Yes	C	C	D	N/A
			No	D	E	E	E
	0	N/A		D	E	F ²	F ²
<1.5	N/A		F ³	F ³	F ³	F ³	
No sidewalk	N/A		C ⁴	F ³	F ³	F ³	

Notes:

1. On-street parking not provided on roadways with posted speed of 70 km/h or more
2. Sidewalk must be 1.8 m wide if no separation is provided (curb-face sidewalk) where speeds are high
3. Sidewalk must be 1.5 m wide to meet Provincial accessibility standards
4. Ottawa Pedestrian Plan, 2014: "all new and reconstructed urban local roads where pedestrian facilities are required in accordance with these policies but no dedicated pedestrian facility is provided, require that roads be designed for a speed of 30 km/h or lower (pending development of a new 30 km/h roadway design standard)." Where a roadway is specifically designed as 'shared space', with appropriate design controls and features, it can achieve LOS A.
5. Where a multi-use path is provided in lieu of sidewalks, the MUP can be evaluated using the same methodology.

Exhibit 11 – BLOS Segment Evaluation Table

Type of Bikeway		LOS
Physically Separated Bikeway (cycle tracks, protected bike lanes and multi-use paths). Physical separation refers to, but is not limited to, curbs, raised medians, bollards and parking lanes (adjacent to the bike lane along the travelled way i.e. not curbside).		A
Bike Lanes Not Adjacent Parking Lane - Select Worst Scoring Criteria		
No. of Travel Lanes	1 travel lane in each direction	A
	2 travel lanes in each direction separated by a raised median	B
	2 travel lanes in each direction without a separating median	C
	More than 2 travel lanes in each direction	D
Bike Lane Width	≥ 1.8 m wide bike lane (includes marked buffer and paved gutter width)	A
	≥ 1.5 m to < 1.8 m wide bike lane (includes marked buffer and paved gutter width)	B
	≥ 1.2 m to < 1.5 m wide bike lane (includes marked buffer and paved gutter width)	C
Operating Speed	≤ 50 km/h operating speed	A
	60 km/h operating speed	C
	> 70 km/h operating speed	E
Bike lane blockage (commercial areas)	Rare	A
	Frequent	C
Bike Lanes Adjacent to curbside Parking Lane - Select Worst Scoring Criteria		
No. of Travel Lanes	1 travel lane in each direction	A
	2 or more travel lanes in each direction	C
Bike Lane and Parking Lane Width	4.5 m wide bike lane plus parking lane (includes marked buffer and paved gutter width)	A
	4.25 m wide bike lane plus parking lane (includes marked buffer and paved gutter width)	B
	≤ 4.0 m wide bike lane plus parking lane (includes marked buffer and paved gutter width)	C
Operating Speed	< 40 km/h operating speed	A
	50 km/h operating speed	B
	60 km/h operating speed	D
	≥ 70 km/h operating speed	F
Bike lane blockage (commercial areas)	Rare	A
	Frequent	C
Mixed Traffic		
No. of Travel Lanes and Operating Speed	2 travel lanes; ≤ 40 km/h; no marked centerline or classified as residential	A
	2 to 3 travel lanes; ≤ 40 km/h	B
	2 travel lanes; 50 km/h; no marked centerline or classified as residential	B
	2 to 3 travel lanes; 50 km/h	D
	4 to 5 travel lanes; ≤ 40 km/h	D
	4 to 5 travel lanes; ≥ 50 km/h	E
	6 or more travel lanes; ≤ 40 km/h	E
≥ 60 km/h	F	
Unsignalized Crossing along Route: no median refuge		
No. of Travel Lanes on Side Street and Operating Speed	3 or less lanes being crossed; ≤ 40 km/h	A
	4 to 5 lanes being crossed; ≤ 40 km/h	B
	3 or less lanes being crossed; 50 km/h	B
	4 to 5 lanes being crossed; 50 km/h	C
	3 or less lanes being crossed; 60 km/h	C
	4 to 5 lanes being crossed; 60 km/h	D
	6 or more lanes being crossed; ≤ 40 km/h	E
	3 or less lanes being crossed; ≥ 65 km/h	E
	6 or more lanes being crossed; ≥ 50 km/h	F
4 to 5 lanes being crossed; ≥ 65 km/h	F	
Unsignalized Crossing along Route: with median refuge (> 1.8 m wide)		
No. of Travel Lanes on Side Street and Operating Speed	5 or less lanes being crossed; ≤ 40 km/h	A
	3 or less lanes being crossed; 50 km/h	A
	6 or more lanes being crossed; ≤ 40 km/h	B
	4 to 5 lanes being crossed; 50 km/h	B
	3 or less lanes being crossed; 60 km/h	B
	6 or more lanes being crossed; 50 km/h	C
	4 to 5 lanes being crossed; 60 km/h	C
	3 or less lanes being crossed; ≥ 65 km/h	D
	6 or more lanes being crossed; 60 km/h	E
	4 to 5 lanes being crossed; ≥ 65 km/h	E
6 or more lanes being crossed; ≥ 65 km/h	F	

Pedestrian Level of Service

Segment	From	To	Side	Sidewalk Width	Blvd Width	AADT per lane	Parking?	Speed	Segment PLOS
Healey Road	Humber Station Road	Coleraine Drive	North	No Sidewalk	0	>3000	No	60	F
			South	No Sidewalk	0	>3000	No	60	F
Humber Station Road	Healey Road	Mayfield Road	East	No Sidewalk	0	>3000	No	80	F
			West	No Sidewalk	0	>3000	No	80	F
Mayfield Road	Humber Station Road	Coleraine Drive	North	No Sidewalk	0	>3000	No	80	F
			South	No Sidewalk	0	>3000	No	80	F
Coleraine Drive	Mayfield Road	George Bolton Parkway	East	No Sidewalk	0	>3000	No	70	F
			West	No Sidewalk	0	>3000	No	70	F
Coleraine Drive	George Bolton Parkway	Healey Road	East	<1.5	0	>3000	No	70	F
			West	<1.5	0	>3000	No	70	F
George Bolton Parkway	Coleraine Drive	Highway 50	North	1.5	>2.0	<3000	No	50	C
			South	<1.5	0	<3000	No	50	F

Bicycle Level of Service

Segment	From	To	Side	Type	No. of Lanes	Bike Lane Width	Operating Speed	Centreline?	Segment BLOS
Healey Road	Humber Station Road	Coleraine Drive	North	Mixed	2 travel lanes	-	60	Yes	F
			South	Mixed	2 travel lanes	-	60	Yes	F
Humber Station Road	Healey Road	Mayfield Road	East	Mixed	2 travel lanes	-	80	Yes	F
			West	Mixed	2 travel lanes	-	80	Yes	F
Mayfield Road	Humber Station Road	Coleraine Drive	North	Mixed	2 travel lanes	-	80	Yes	F
			South	Mixed	2 travel lanes	-	80	Yes	F
Coleraine Drive	Mayfield Road	George Bolton Parkway	East	Mixed	4 travel lanes	-	70	Yes	F
			West	Mixed	4 travel lanes	-	70	Yes	F
Coleraine Drive	George Bolton Parkway	Healey Road	East	Mixed	4 travel lanes	-	70	Yes	F
			West	Mixed	4 travel lanes	-	70	Yes	F
George Bolton Parkway	Coleraine Drive	Highway 50	North	Bike Lane wo Parking	2 travel lanes	1.5-1.8	50	Yes	B
			South	Bike Lane wo Parking	2 travel lanes	1.5-1.8	50	Yes	B



APPENDIX B

TMCs & STPs



LEA Consulting Ltd.
625 Cochrane Drive

Markam, Ontario, Canada L3R 9R9
905-470-0015 x240 idinsmore@lea.ca

Count Name: 23347_Coleraine Dr & Healy Rd-AM
Site Code: 23347
Start Date: 05/03/2023
Page No: 1

Turning Movement Data

Start Time	Coleraine Drive Southbound						Healy Road Westbound						Coleraine Drive Northbound						Healy Road Eastbound						Int. Total
	Right	Thru	Left	U-Turn	Peds	App. Total	Right	Thru	Left	U-Turn	Peds	App. Total	Right	Thru	Left	U-Turn	Peds	App. Total	Right	Thru	Left	U-Turn	Peds	App. Total	
7:00 AM	41	71	19	0	0	131	6	20	7	0	0	33	4	26	6	0	0	36	69	54	25	0	0	148	348
7:15 AM	51	60	12	0	0	123	6	26	6	0	0	38	9	33	6	0	0	48	56	69	30	0	0	155	364
7:30 AM	49	71	17	0	0	137	5	31	6	1	0	43	5	21	7	0	0	33	42	82	38	0	0	162	375
7:45 AM	21	63	16	0	0	100	5	24	5	0	0	34	4	21	7	0	0	32	29	91	28	0	0	148	314
Hourly Total	162	265	64	0	0	491	22	101	24	1	0	148	22	101	26	0	0	149	196	296	121	0	0	613	1401
8:00 AM	42	64	18	0	0	124	7	23	6	0	0	36	5	31	7	0	0	43	24	73	33	0	0	130	333
8:15 AM	27	70	6	0	0	103	9	18	9	0	0	36	6	32	3	0	0	41	14	72	34	0	0	120	300
8:30 AM	30	55	15	0	0	100	10	20	3	0	0	33	5	21	7	0	0	33	21	60	27	0	0	108	274
8:45 AM	12	52	20	0	0	84	7	36	4	0	0	47	4	25	1	0	0	30	37	66	36	0	0	139	300
Hourly Total	111	241	59	0	0	411	33	97	22	0	0	152	20	109	18	0	0	147	96	271	130	0	0	497	1207
9:00 AM	11	60	13	0	0	84	9	26	2	0	0	37	7	39	2	0	0	48	9	59	20	0	0	88	257
9:15 AM	16	50	17	0	0	83	1	23	3	0	0	27	8	29	3	0	0	40	11	53	24	0	0	88	238
9:30 AM	0	0	0	0	0	0	0	0	0	0	0	0	0	0	0	0	0	0	0	0	0	0	0	0	0
Grand Total	300	616	153	0	0	1069	65	247	51	1	0	364	57	278	49	0	0	384	312	679	295	0	0	1286	3103
Approach %	28.1	57.6	14.3	0.0	-	-	17.9	67.9	14.0	0.3	-	-	14.8	72.4	12.8	0.0	-	-	24.3	52.8	22.9	0.0	-	-	-
Total %	9.7	19.9	4.9	0.0	-	34.5	2.1	8.0	1.6	0.0	-	11.7	1.8	9.0	1.6	0.0	-	12.4	10.1	21.9	9.5	0.0	-	41.4	-
Lights	292	484	124	0	-	900	40	223	30	1	-	294	43	150	46	0	-	239	309	666	289	0	-	1264	2697
% Lights	97.3	78.6	81.0	-	-	84.2	61.5	90.3	58.8	100.0	-	80.8	75.4	54.0	93.9	-	-	62.2	99.0	98.1	98.0	-	-	98.3	86.9
Buses	4	2	0	0	-	6	0	17	1	0	-	18	0	4	1	0	-	5	2	9	4	0	-	15	44
% Buses	1.3	0.3	0.0	-	-	0.6	0.0	6.9	2.0	0.0	-	4.9	0.0	1.4	2.0	-	-	1.3	0.6	1.3	1.4	-	-	1.2	1.4
Trucks	4	130	29	0	-	163	25	7	20	0	-	52	14	124	2	0	-	140	1	4	2	0	-	7	362
% Trucks	1.3	21.1	19.0	-	-	15.2	38.5	2.8	39.2	0.0	-	14.3	24.6	44.6	4.1	-	-	36.5	0.3	0.6	0.7	-	-	0.5	11.7
Bicycles on Road	0	0	0	0	-	0	0	0	0	0	-	0	0	0	0	0	-	0	0	0	0	0	-	0	0
% Bicycles on Road	0.0	0.0	0.0	-	-	0.0	0.0	0.0	0.0	0.0	-	0.0	0.0	0.0	0.0	-	-	0.0	0.0	0.0	0.0	-	-	0.0	0.0
Bicycles on Crosswalk	-	-	-	-	0	-	-	-	-	-	0	-	-	-	-	-	0	-	-	-	-	-	0	-	-
% Bicycles on Crosswalk	-	-	-	-	-	-	-	-	-	-	-	-	-	-	-	-	-	-	-	-	-	-	-	-	-
Pedestrians	-	-	-	-	0	-	-	-	-	-	0	-	-	-	-	-	0	-	-	-	-	-	0	-	-
% Pedestrians	-	-	-	-	-	-	-	-	-	-	-	-	-	-	-	-	-	-	-	-	-	-	-	-	-



LEA Consulting Ltd.
625 Cochrane Drive

Markam, Ontario, Canada L3R 9R9
905-470-0015 x240 idinsmore@lea.ca

Count Name: 23347_Coleraine Dr & Healy Rd-AM
Site Code: 23347
Start Date: 05/03/2023
Page No: 2

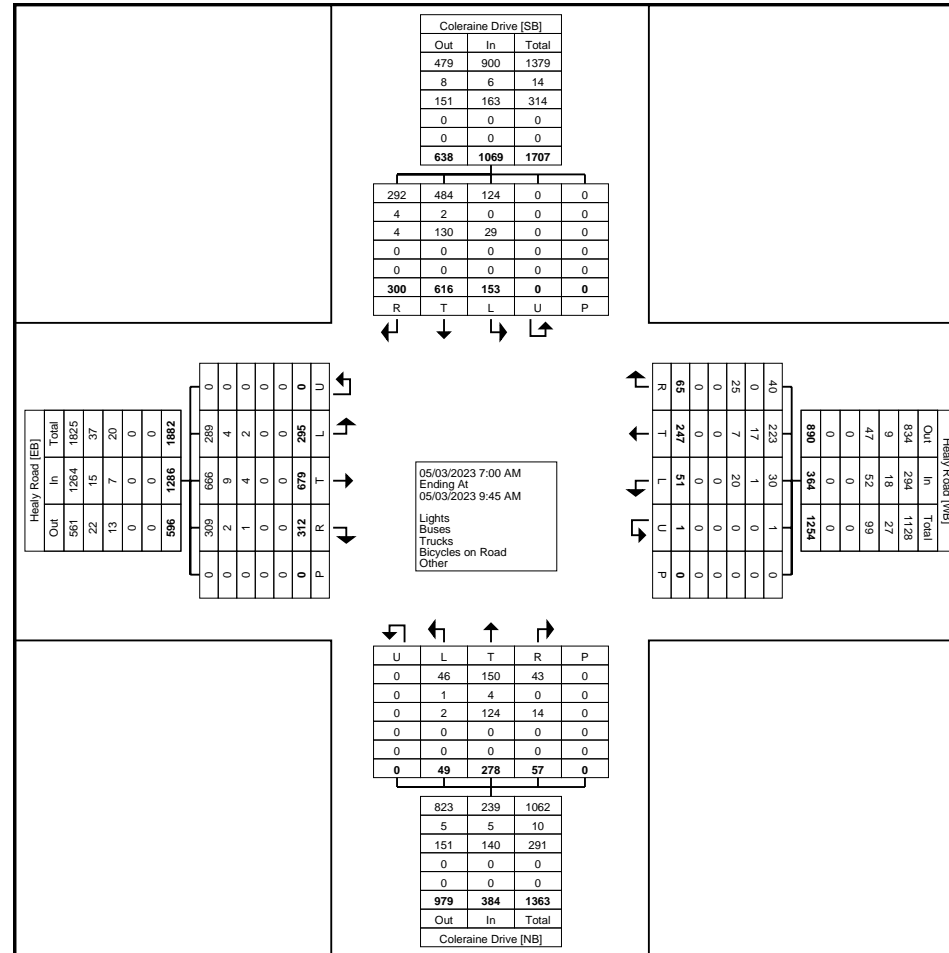

Turning Movement Data Plot



LEA Consulting Ltd.
625 Cochrane Drive

Markam, Ontario, Canada L3R 9R9
905-470-0015 x240 idinsmore@lea.ca

Count Name: 23347_Coleraine Dr & Healy Rd-AM
Site Code: 23347
Start Date: 05/03/2023
Page No: 3

Turning Movement Peak Hour Data (7:00 AM)

Start Time	Coleraine Drive Southbound						Healy Road Westbound						Coleraine Drive Northbound						Healy Road Eastbound						Int. Total
	Right	Thru	Left	U-Turn	Peds	App. Total	Right	Thru	Left	U-Turn	Peds	App. Total	Right	Thru	Left	U-Turn	Peds	App. Total	Right	Thru	Left	U-Turn	Peds	App. Total	
7:00 AM	41	71	19	0	0	131	6	20	7	0	0	33	4	26	6	0	0	36	69	54	25	0	0	148	348
7:15 AM	51	60	12	0	0	123	6	26	6	0	0	38	9	33	6	0	0	48	56	69	30	0	0	155	364
7:30 AM	49	71	17	0	0	137	5	31	6	1	0	43	5	21	7	0	0	33	42	82	38	0	0	162	375
7:45 AM	21	63	16	0	0	100	5	24	5	0	0	34	4	21	7	0	0	32	29	91	28	0	0	148	314
Total	162	265	64	0	0	491	22	101	24	1	0	148	22	101	26	0	0	149	196	296	121	0	0	613	1401
Approach %	33.0	54.0	13.0	0.0	-	-	14.9	68.2	16.2	0.7	-	-	14.8	67.8	17.4	0.0	-	-	32.0	48.3	19.7	0.0	-	-	-
Total %	11.6	18.9	4.6	0.0	-	35.0	1.6	7.2	1.7	0.1	-	10.6	1.6	7.2	1.9	0.0	-	10.6	14.0	21.1	8.6	0.0	-	43.8	-
PHF	0.794	0.933	0.842	0.000	-	0.896	0.917	0.815	0.857	0.250	-	0.860	0.611	0.765	0.929	0.000	-	0.776	0.710	0.813	0.796	0.000	-	0.946	0.934
Lights	159	216	46	0	-	421	7	98	16	1	-	122	17	56	26	0	-	99	196	290	117	0	-	603	1245
% Lights	98.1	81.5	71.9	-	-	85.7	31.8	97.0	66.7	100.0	-	82.4	77.3	55.4	100.0	-	-	66.4	100.0	98.0	96.7	-	-	98.4	88.9
Buses	1	0	0	0	-	1	0	2	0	0	-	2	0	3	0	0	-	3	0	5	3	0	-	8	14
% Buses	0.6	0.0	0.0	-	-	0.2	0.0	2.0	0.0	0.0	-	1.4	0.0	3.0	0.0	-	-	2.0	0.0	1.7	2.5	-	-	1.3	1.0
Trucks	2	49	18	0	-	69	15	1	8	0	-	24	5	42	0	0	-	47	0	1	1	0	-	2	142
% Trucks	1.2	18.5	28.1	-	-	14.1	68.2	1.0	33.3	0.0	-	16.2	22.7	41.6	0.0	-	-	31.5	0.0	0.3	0.8	-	-	0.3	10.1
Bicycles on Road	0	0	0	0	-	0	0	0	0	0	-	0	0	0	0	0	-	0	0	0	0	0	-	0	0
% Bicycles on Road	0.0	0.0	0.0	-	-	0.0	0.0	0.0	0.0	0.0	-	0.0	0.0	0.0	0.0	-	-	0.0	0.0	0.0	0.0	-	-	0.0	0.0
Bicycles on Crosswalk	-	-	-	-	0	-	-	-	-	-	0	-	-	-	-	-	0	-	-	-	-	-	0	-	-
% Bicycles on Crosswalk	-	-	-	-	-	-	-	-	-	-	-	-	-	-	-	-	-	-	-	-	-	-	-	-	-
Pedestrians	-	-	-	-	0	-	-	-	-	-	0	-	-	-	-	-	0	-	-	-	-	-	0	-	-
% Pedestrians	-	-	-	-	-	-	-	-	-	-	-	-	-	-	-	-	-	-	-	-	-	-	-	-	-



LEA Consulting Ltd.
625 Cochrane Drive

Markam, Ontario, Canada L3R 9R9
905-470-0015 x240 idinsmore@lea.ca

Count Name: 23347_Coleraine Dr & Healy Rd-AM
Site Code: 23347
Start Date: 05/03/2023
Page No: 4

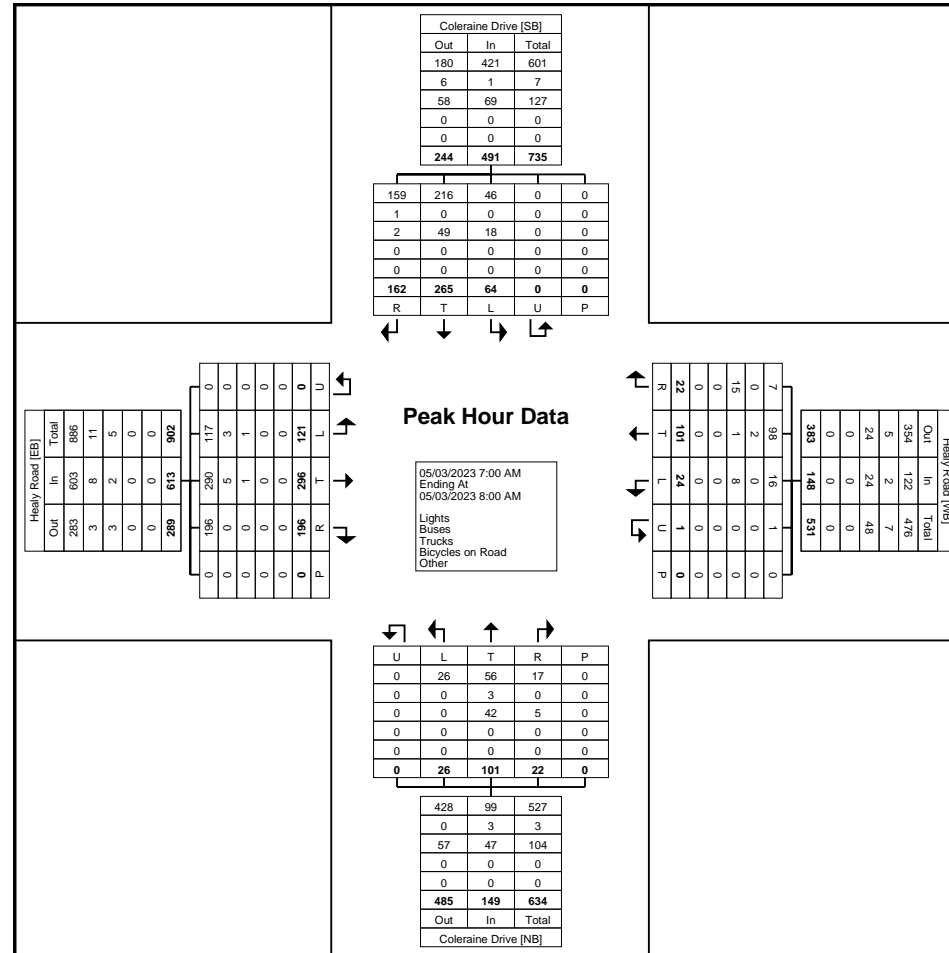

Turning Movement Peak Hour Data Plot (7:00 AM)



LEA Consulting Ltd.
625 Cochrane Drive

Markam, Ontario, Canada L3R 9R9
905-470-0015 x240 idinsmore@lea.ca

Count Name: 23347_Coleraine Dr & Healy Rd-
PM
Site Code: 23347
Start Date: 05/03/2023
Page No: 1

Turning Movement Data

Start Time	Coleraine Drive Southbound						Healey Road Westbound						Coleraine Drive Northbound						Healey Road Eastbound						Int. Total
	Right	Thru	Left	U-Turn	Peds	App. Total	Right	Thru	Left	U-Turn	Peds	App. Total	Right	Thru	Left	U-Turn	Peds	App. Total	Right	Thru	Left	U-Turn	Peds	App. Total	
4:00 PM	21	51	11	0	0	83	34	53	20	0	0	107	13	73	23	1	0	110	27	51	40	0	0	118	418
4:15 PM	19	52	13	0	0	84	18	60	5	0	0	83	11	58	25	0	0	94	9	52	28	0	0	89	350
4:30 PM	22	39	12	0	0	73	15	90	2	0	0	107	12	64	27	1	0	104	3	51	25	0	0	79	363
4:45 PM	19	32	10	0	0	61	15	85	7	0	0	107	7	59	31	0	0	97	12	49	38	0	0	99	364
Hourly Total	81	174	46	0	0	301	82	288	34	0	0	404	43	254	106	2	0	405	51	203	131	0	0	385	1495
5:00 PM	29	33	9	0	0	71	13	113	7	0	0	133	13	78	39	0	0	130	3	17	32	0	0	52	386
5:15 PM	22	37	18	0	0	77	28	78	6	0	0	112	7	78	48	0	0	133	13	49	26	0	0	88	410
5:30 PM	16	32	10	0	0	58	24	73	15	0	0	112	11	82	89	0	0	182	36	36	24	0	0	96	448
5:45 PM	5	42	10	0	0	57	20	40	10	0	0	70	8	65	35	0	0	108	40	36	28	0	0	104	339
Hourly Total	72	144	47	0	0	263	85	304	38	0	0	427	39	303	211	0	0	553	92	138	110	0	0	340	1583
6:00 PM	26	46	9	0	0	81	13	65	12	0	0	90	14	84	82	0	0	180	35	27	23	0	0	85	436
6:15 PM	19	37	13	0	0	69	7	34	7	0	0	48	11	59	25	0	0	95	44	34	19	0	0	97	309
6:30 PM	0	1	0	0	0	1	0	0	0	0	0	0	0	0	0	0	0	0	0	0	0	0	0	0	1
Grand Total	198	402	115	0	0	715	187	691	91	0	0	969	107	700	424	2	0	1233	222	402	283	0	0	907	3824
Approach %	27.7	56.2	16.1	0.0	-	-	19.3	71.3	9.4	0.0	-	-	8.7	56.8	34.4	0.2	-	-	24.5	44.3	31.2	0.0	-	-	-
Total %	5.2	10.5	3.0	0.0	-	18.7	4.9	18.1	2.4	0.0	-	25.3	2.8	18.3	11.1	0.1	-	32.2	5.8	10.5	7.4	0.0	-	23.7	-
Lights	195	267	94	0	-	556	155	686	77	0	-	918	87	549	422	2	-	1060	220	393	278	0	-	891	3425
% Lights	98.5	66.4	81.7	-	-	77.8	82.9	99.3	84.6	-	-	94.7	81.3	78.4	99.5	100.0	-	86.0	99.1	97.8	98.2	-	-	98.2	89.6
Buses	1	2	0	0	-	3	0	1	0	0	-	1	1	0	0	0	-	1	1	2	3	0	-	6	11
% Buses	0.5	0.5	0.0	-	-	0.4	0.0	0.1	0.0	-	-	0.1	0.9	0.0	0.0	0.0	-	0.1	0.5	0.5	1.1	-	-	0.7	0.3
Trucks	2	133	21	0	-	156	32	4	14	0	-	50	19	151	2	0	-	172	1	7	2	0	-	10	388
% Trucks	1.0	33.1	18.3	-	-	21.8	17.1	0.6	15.4	-	-	5.2	17.8	21.6	0.5	0.0	-	13.9	0.5	1.7	0.7	-	-	1.1	10.1
Bicycles on Road	0	0	0	0	-	0	0	0	0	0	-	0	0	0	0	0	-	0	0	0	0	0	-	0	0
% Bicycles on Road	0.0	0.0	0.0	-	-	0.0	0.0	0.0	0.0	-	-	0.0	0.0	0.0	0.0	0.0	-	0.0	0.0	0.0	0.0	-	-	0.0	0.0
Bicycles on Crosswalk	-	-	-	-	0	-	-	-	-	-	0	-	-	-	-	-	0	-	-	-	-	-	0	-	-
% Bicycles on Crosswalk	-	-	-	-	-	-	-	-	-	-	-	-	-	-	-	-	-	-	-	-	-	-	-	-	-
Pedestrians	-	-	-	-	0	-	-	-	-	-	0	-	-	-	-	-	0	-	-	-	-	-	0	-	-
% Pedestrians	-	-	-	-	-	-	-	-	-	-	-	-	-	-	-	-	-	-	-	-	-	-	-	-	-



LEA Consulting Ltd.
625 Cochrane Drive

Markam, Ontario, Canada L3R 9R9
905-470-0015 x240 idinsmore@lea.ca

Count Name: 23347_Coleraine Dr & Healy Rd-
PM
Site Code: 23347
Start Date: 05/03/2023
Page No: 2

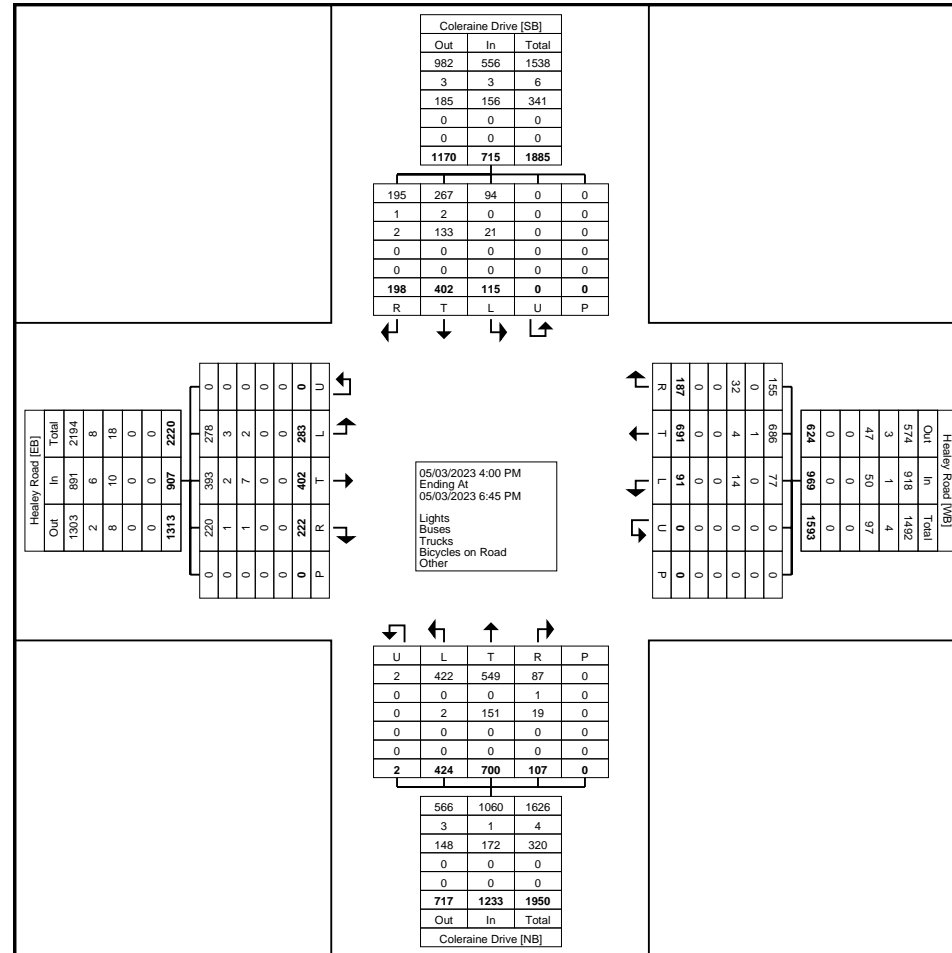

Turning Movement Data Plot



LEA Consulting Ltd.
625 Cochrane Drive

Markam, Ontario, Canada L3R 9R9
905-470-0015 x240 idinsmore@lea.ca

Count Name: 23347_Coleraine Dr & Healy Rd-
PM
Site Code: 23347
Start Date: 05/03/2023
Page No: 3

Turning Movement Peak Hour Data (5:15 PM)

Start Time	Coleraine Drive Southbound						Healey Road Westbound						Coleraine Drive Northbound						Healey Road Eastbound						Int. Total
	Right	Thru	Left	U-Turn	Peds	App. Total	Right	Thru	Left	U-Turn	Peds	App. Total	Right	Thru	Left	U-Turn	Peds	App. Total	Right	Thru	Left	U-Turn	Peds	App. Total	
5:15 PM	22	37	18	0	0	77	28	78	6	0	0	112	7	78	48	0	0	133	13	49	26	0	0	88	410
5:30 PM	16	32	10	0	0	58	24	73	15	0	0	112	11	82	89	0	0	182	36	36	24	0	0	96	448
5:45 PM	5	42	10	0	0	57	20	40	10	0	0	70	8	65	35	0	0	108	40	36	28	0	0	104	339
6:00 PM	26	46	9	0	0	81	13	65	12	0	0	90	14	84	82	0	0	180	35	27	23	0	0	85	436
Total	69	157	47	0	0	273	85	256	43	0	0	384	40	309	254	0	0	603	124	148	101	0	0	373	1633
Approach %	25.3	57.5	17.2	0.0	-	-	22.1	66.7	11.2	0.0	-	-	6.6	51.2	42.1	0.0	-	-	33.2	39.7	27.1	0.0	-	-	-
Total %	4.2	9.6	2.9	0.0	-	16.7	5.2	15.7	2.6	0.0	-	23.5	2.4	18.9	15.6	0.0	-	36.9	7.6	9.1	6.2	0.0	-	22.8	-
PHF	0.663	0.853	0.653	0.000	-	0.843	0.759	0.821	0.717	0.000	-	0.857	0.714	0.920	0.713	0.000	-	0.828	0.775	0.755	0.902	0.000	-	0.897	0.911
Lights	68	113	38	0	-	219	71	255	40	0	-	366	33	252	253	0	-	538	124	147	99	0	-	370	1493
% Lights	98.6	72.0	80.9	-	-	80.2	83.5	99.6	93.0	-	-	95.3	82.5	81.6	99.6	-	-	89.2	100.0	99.3	98.0	-	-	99.2	91.4
Buses	0	0	0	0	-	0	0	0	0	0	-	0	0	0	0	0	-	0	0	0	1	0	-	1	1
% Buses	0.0	0.0	0.0	-	-	0.0	0.0	0.0	0.0	-	-	0.0	0.0	0.0	0.0	-	-	0.0	0.0	0.0	1.0	-	-	0.3	0.1
Trucks	1	44	9	0	-	54	14	1	3	0	-	18	7	57	1	0	-	65	0	1	1	0	-	2	139
% Trucks	1.4	28.0	19.1	-	-	19.8	16.5	0.4	7.0	-	-	4.7	17.5	18.4	0.4	-	-	10.8	0.0	0.7	1.0	-	-	0.5	8.5
Bicycles on Road	0	0	0	0	-	0	0	0	0	0	-	0	0	0	0	0	-	0	0	0	0	0	-	0	0
% Bicycles on Road	0.0	0.0	0.0	-	-	0.0	0.0	0.0	0.0	-	-	0.0	0.0	0.0	0.0	-	-	0.0	0.0	0.0	0.0	-	-	0.0	0.0
Bicycles on Crosswalk	-	-	-	-	0	-	-	-	-	-	0	-	-	-	-	-	0	-	-	-	-	-	0	-	-
% Bicycles on Crosswalk	-	-	-	-	-	-	-	-	-	-	-	-	-	-	-	-	-	-	-	-	-	-	-	-	-
Pedestrians	-	-	-	-	0	-	-	-	-	-	0	-	-	-	-	-	0	-	-	-	-	-	0	-	-
% Pedestrians	-	-	-	-	-	-	-	-	-	-	-	-	-	-	-	-	-	-	-	-	-	-	-	-	-



LEA Consulting Ltd.
625 Cochrane Drive

Markam, Ontario, Canada L3R 9R9
905-470-0015 x240 idinsmore@lea.ca

Count Name: 23347_Coleraine Dr & Healy Rd-
PM
Site Code: 23347
Start Date: 05/03/2023
Page No: 4

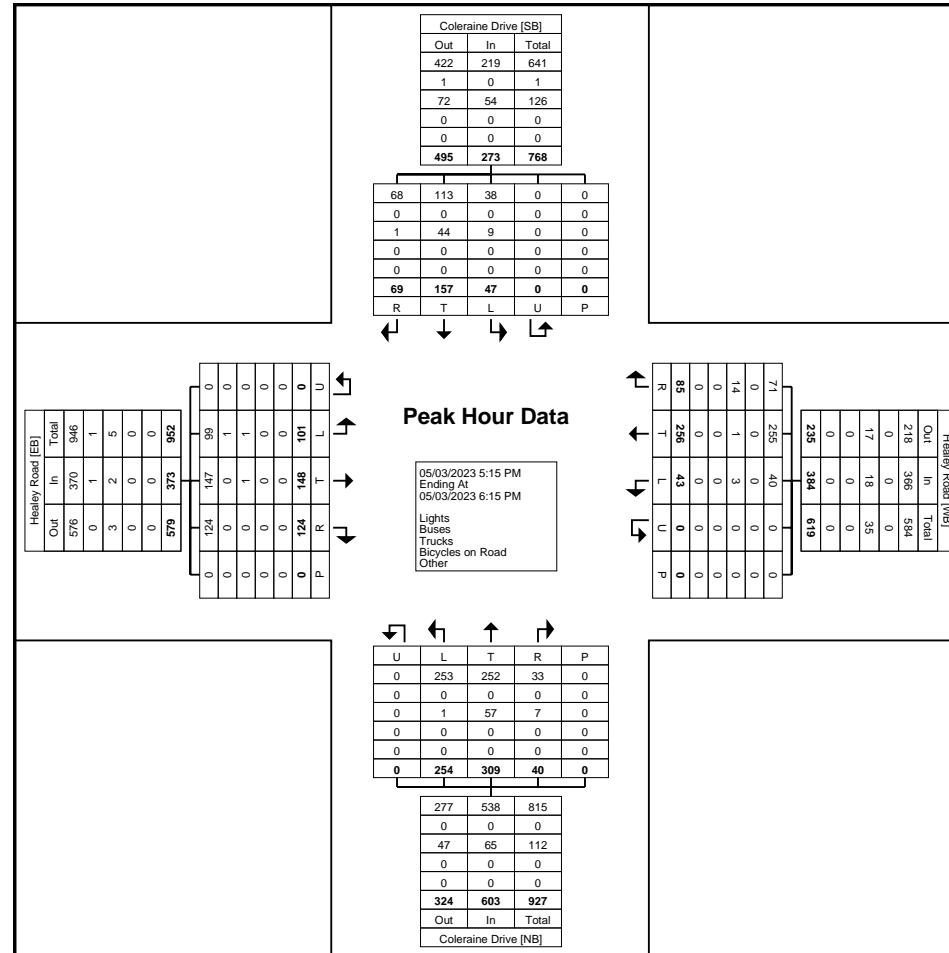

Turning Movement Peak Hour Data Plot (5:15 PM)

LEA Consulting Ltd.

625 Cochrane Drive, 5th Floor
Markham, ON L3R 9R9

Project No.: 23347
Intersection: Humber Station Rd & Healey
Weather: Rain
Surveyor(s): ID

File Name : Humber Station Rd & Healey Rd - AM
Site Code : 00023347
Start Date : 2023-05-03
Page No : 1

Groups Printed- Cars/lights - Trucks - Buses

Start Time	Humber Station Road Southbound					Healey Road Westbound					Humber Station Road Northbound					Healey Road Eastbound					Exclu. Total	Inclu. Total	Int. Total
	Left	Thru	Right	Peds	App. Total	Left	Thru	Right	Peds	App. Total	Left	Thru	Right	Peds	App. Total	Left	Thru	Right	Peds	App. Total			
07:00	15	34	0	[0]	49	23	46	0	[0]	69	0	3	4	[0]	7	2	131	2	[0]	135	0	260	260
07:15	21	46	2	[0]	69	18	60	0	[0]	78	2	7	8	[0]	17	1	129	3	[0]	133	0	297	297
07:30	15	43	1	[0]	59	21	60	2	[0]	83	2	2	10	[0]	14	0	117	10	[0]	127	0	283	283
07:45	21	39	1	[0]	61	11	44	2	[0]	57	2	4	9	[0]	15	1	122	4	[0]	127	0	260	260
Total	72	162	4	[0]	238	73	210	4	[0]	287	6	16	31	[0]	53	4	499	19	[0]	522	0	1100	1100
08:00	6	33	0	[0]	39	17	45	1	[0]	63	1	10	10	[0]	21	1	99	3	[0]	103	0	226	226
08:15	15	54	0	[0]	69	16	35	2	[0]	53	1	5	5	[0]	11	1	103	13	[0]	117	0	250	250
08:30	9	26	2	[0]	37	16	42	4	[0]	62	1	4	7	[0]	12	3	96	5	[0]	104	0	215	215
08:45	14	17	1	[0]	32	7	41	0	[0]	48	4	3	8	[0]	15	1	109	6	[0]	116	0	211	211
Total	44	130	3	[0]	177	56	163	7	[0]	226	7	22	30	[0]	59	6	407	27	[0]	440	0	902	902
09:00	10	22	0	[0]	32	3	31	2	[0]	36	0	9	8	[0]	17	4	79	2	[0]	85	0	170	170
09:15	10	24	1	[0]	35	8	40	1	[0]	49	4	7	5	[0]	16	1	71	5	[0]	77	0	177	177
Grand Total	136	338	8	[0]	482	140	444	14	[0]	598	17	54	74	[0]	145	15	1056	53	[0]	1124	0	2349	2349
Apprch %	28.2	70.1	1.7			23.4	74.2	2.3			11.7	37.2	51			1.3	94	4.7					
Total %	5.8	14.4	0.3		20.5	6	18.9	0.6		25.5	0.7	2.3	3.2		6.2	0.6	45	2.3		47.9	0	100	
Cars/lights	134	336	7		477	132	416	13		561	14	54	69		137	14	1041	53		1108	0	0	2283
% Cars/lights	98.5	99.4	87.5	0	99	94.3	93.7	92.9	0	93.8	82.4	100	93.2	0	94.5	93.3	98.6	100	0	98.6	0	0	97.2
Trucks	1	2	1		4	3	11	1		15	1	0	1		2	0	5	0		5	0	0	26
% Trucks	0.7	0.6	12.5	0	0.8	2.1	2.5	7.1	0	2.5	5.9	0	1.4	0	1.4	0	0.5	0	0	0.4	0	0	1.1
Buses	1	0	0		1	5	17	0		22	2	0	4		6	1	10	0		11	0	0	40
% Buses	0.7	0	0	0	0.2	3.6	3.8	0	0	3.7	11.8	0	5.4	0	4.1	6.7	0.9	0	0	1	0	0	1.7

LEA Consulting Ltd.

625 Cochrane Drive, 5th Floor
Markham, ON L3R 9R9

File Name : Humber Station Rd & Healey Rd - AM

Site Code : 00023347

Start Date : 2023-05-03

Page No : 2

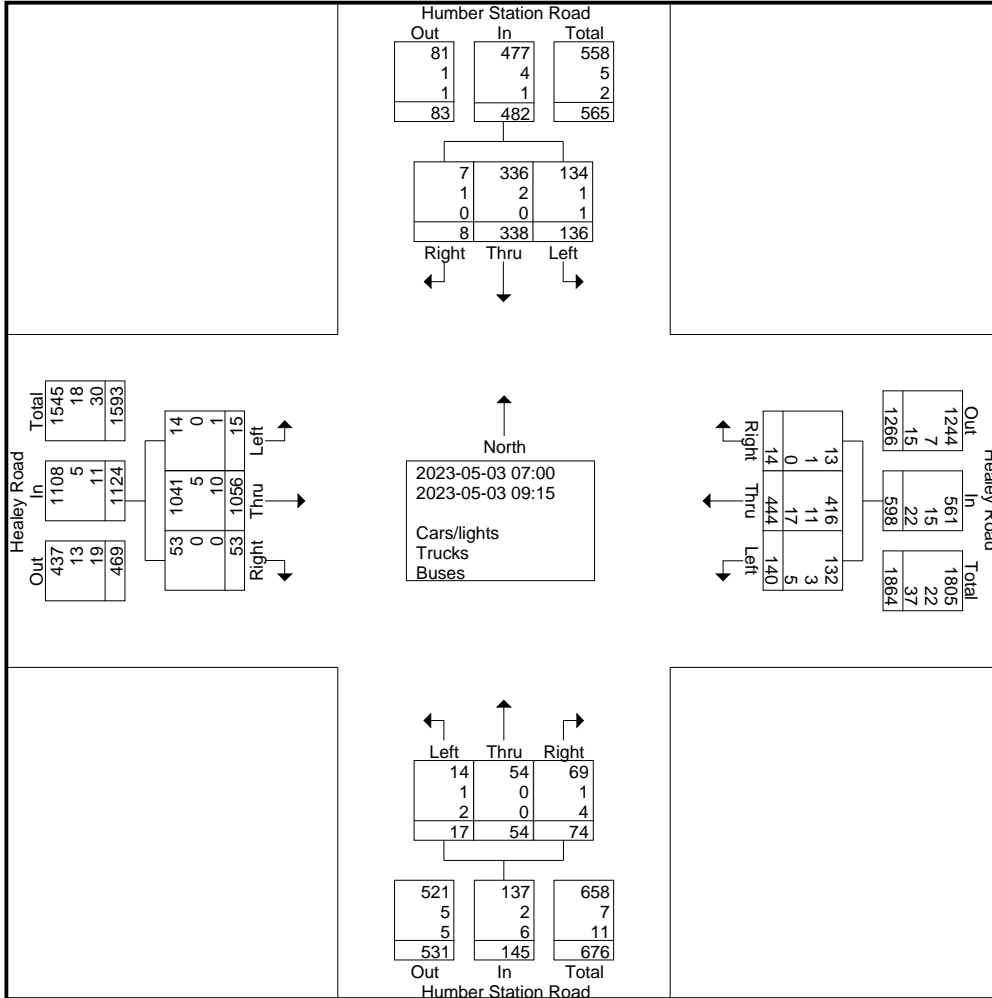

LEA Consulting Ltd.

625 Cochrane Drive, 5th Floor
Markham, ON L3R 9R9

File Name : Humber Station Rd & Healey Rd - AM
Site Code : 00023347
Start Date : 2023-05-03
Page No : 3

Start Time	Humber Station Road Southbound				Healey Road Westbound				Humber Station Road Northbound				Healey Road Eastbound				Int. Total
	Left	Thru	Right	App. Total	Left	Thru	Right	App. Total	Left	Thru	Right	App. Total	Left	Thru	Right	App. Total	
Peak Hour Analysis From 07:00 to 09:15 - Peak 1 of 1																	
Peak Hour for Entire Intersection Begins at 07:00																	
07:00	15	34	0	49	23	46	0	69	0	3	4	7	2	131	2	135	260
07:15	21	46	2	69	18	60	0	78	2	7	8	17	1	129	3	133	297
07:30	15	43	1	59	21	60	2	83	2	2	10	14	0	117	10	127	283
07:45	21	39	1	61	11	44	2	57	2	4	9	15	1	122	4	127	260
Total Volume	72	162	4	238	73	210	4	287	6	16	31	53	4	499	19	522	1100
% App. Total	30.3	68.1	1.7		25.4	73.2	1.4		11.3	30.2	58.5		0.8	95.6	3.6		
PHF	.857	.880	.500	.862	.793	.875	.500	.864	.750	.571	.775	.779	.500	.952	.475	.967	.926
Cars/lights	72	161	4	237	72	206	3	281	6	16	30	52	3	491	19	513	1083
% Cars/lights	100	99.4	100	99.6	98.6	98.1	75.0	97.9	100	100	96.8	98.1	75.0	98.4	100	98.3	98.5
Trucks	0	1	0	1	0	2	1	3	0	0	0	0	0	1	0	1	5
% Trucks	0	0.6	0	0.4	0	1.0	25.0	1.0	0	0	0	0	0	0.2	0	0.2	0.5
Buses	0	0	0	0	1	2	0	3	0	0	1	1	1	7	0	8	12
% Buses	0	0	0	0	1.4	1.0	0	1.0	0	0	3.2	1.9	25.0	1.4	0	1.5	1.1

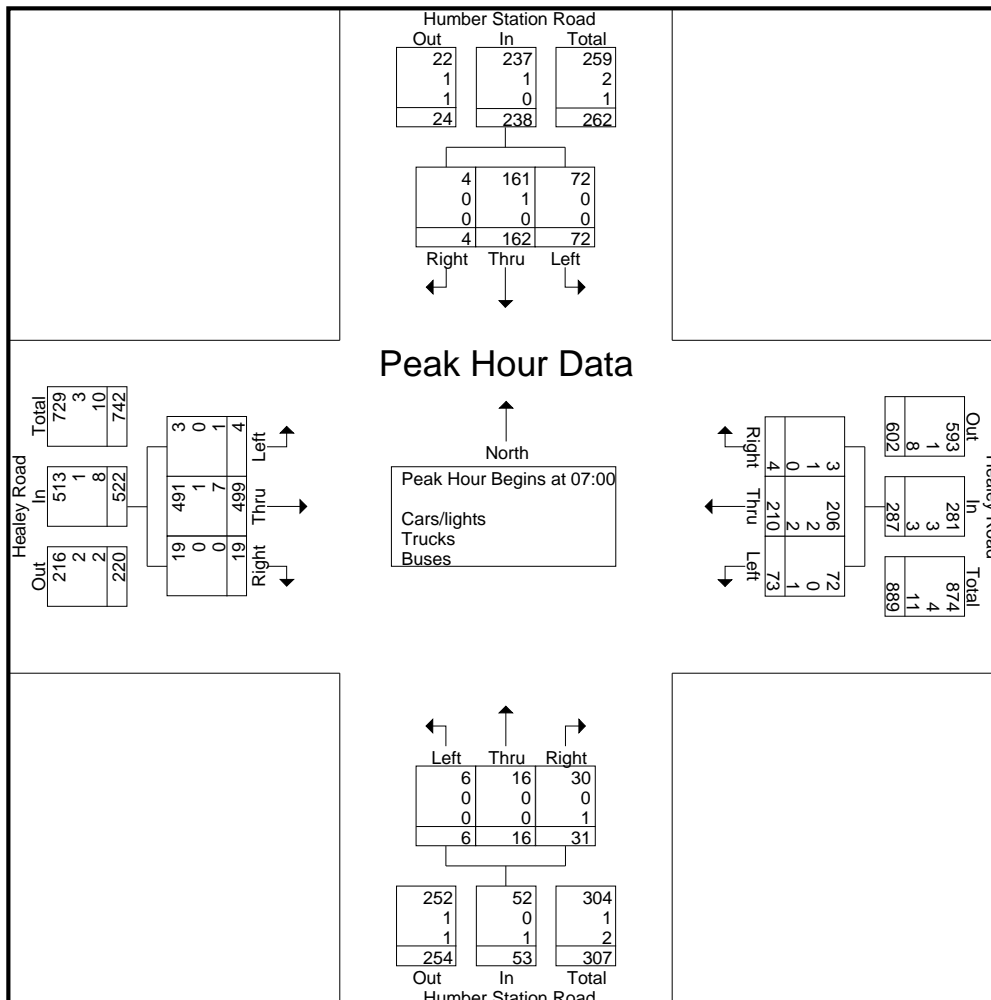

LEA Consulting Ltd.

625 Cochrane Drive, 5th Floor
Markham, ON L3R 9R9

LEA Consulting Ltd.

625 Cochrane Drive, 5th Floor
Markham, ON L3R 9R9

Project No.: 23347
Intersection: Humber Station Rd & Healey
Weather: Rain
Surveyor(s): ID

File Name : Humber Station Rd & Healey Rd - PM
Site Code : 00023347
Start Date : 2023-05-03
Page No : 1

Groups Printed- Cars/lights - Trucks - Buses

Start Time	Humber Station Road Southbound					Healey Road Westbound					Humber Station Road Northbound					Healey Road Eastbound					Exclu. Total	Inclu. Total	Int. Total
	Left	Thru	Right	Peds	App. Total	Left	Thru	Right	Peds	App. Total	Left	Thru	Right	Peds	App. Total	Left	Thru	Right	Peds	App. Total			
16:00	5	14	5	[0]	24	9	109	11	[0]	129	11	37	11	[0]	59	1	69	2	[0]	72	0	284	284
16:15	3	16	0	[0]	19	12	121	7	[0]	140	7	34	16	[0]	57	6	64	3	[0]	73	0	289	289
16:30	5	11	2	[0]	18	9	129	8	[0]	146	4	38	14	[0]	56	0	60	2	[0]	62	0	282	282
16:45	6	6	1	[0]	13	7	123	14	[0]	144	4	35	18	[0]	57	2	73	0	[0]	75	0	289	289
Total	19	47	8	[0]	74	37	482	40	[0]	559	26	144	59	[0]	229	9	266	7	[0]	282	0	1144	1144
17:00	4	14	3	[0]	21	10	124	6	[0]	140	5	53	20	[0]	78	9	51	1	[0]	61	0	300	300
17:15	6	13	3	[0]	22	5	132	6	[0]	143	1	44	15	[0]	60	1	64	1	[0]	66	0	291	291
17:30	8	7	0	[0]	15	10	123	5	[0]	138	6	35	13	[0]	54	4	62	2	[0]	68	0	275	275
17:45	4	8	0	[0]	12	9	117	5	[0]	131	4	55	17	[0]	76	7	70	2	[0]	79	0	298	298
Total	22	42	6	[0]	70	34	496	22	[0]	552	16	187	65	[0]	268	21	247	6	[0]	274	0	1164	1164
18:00	2	9	1	[0]	12	10	135	7	[0]	152	2	34	18	[0]	54	1	63	0	[0]	64	0	282	282
18:15	8	14	3	[0]	25	7	113	4	[0]	124	1	20	9	[0]	30	4	82	1	[0]	87	0	266	266
Grand Total	51	112	18	[0]	181	88	1226	73	[0]	1387	45	385	151	[0]	581	35	658	14	[0]	707	0	2856	2856
Apprch %	28.2	61.9	9.9			6.3	88.4	5.3			7.7	66.3	26			5	93.1	2					
Total %	1.8	3.9	0.6		6.3	3.1	42.9	2.6		48.6	1.6	13.5	5.3		20.3	1.2	23	0.5		24.8	0	100	
Cars/lights	51	109	18		178	87	1218	72		1377	45	382	148		575	35	649	14		698	0	0	2828
% Cars/lights	100	97.3	100	0	98.3	98.9	99.3	98.6	0	99.3	100	99.2	98	0	99	100	98.6	100	0	98.7	0	0	99
Trucks	0	3	0		3	1	7	1		9	0	3	2		5	0	6	0		6	0	0	23
% Trucks	0	2.7	0	0	1.7	1.1	0.6	1.4	0	0.6	0	0.8	1.3	0	0.9	0	0.9	0	0	0.8	0	0	0.8
Buses	0	0	0		0	0	1	0		1	0	0	1		1	0	3	0		3	0	0	5
% Buses	0	0	0	0	0	0	0.1	0	0	0.1	0	0	0.7	0	0.2	0	0.5	0	0	0.4	0	0	0.2

LEA Consulting Ltd.

625 Cochrane Drive, 5th Floor
Markham, ON L3R 9R9

File Name : Humber Station Rd & Healey Rd - PM

Site Code : 00023347

Start Date : 2023-05-03

Page No : 2

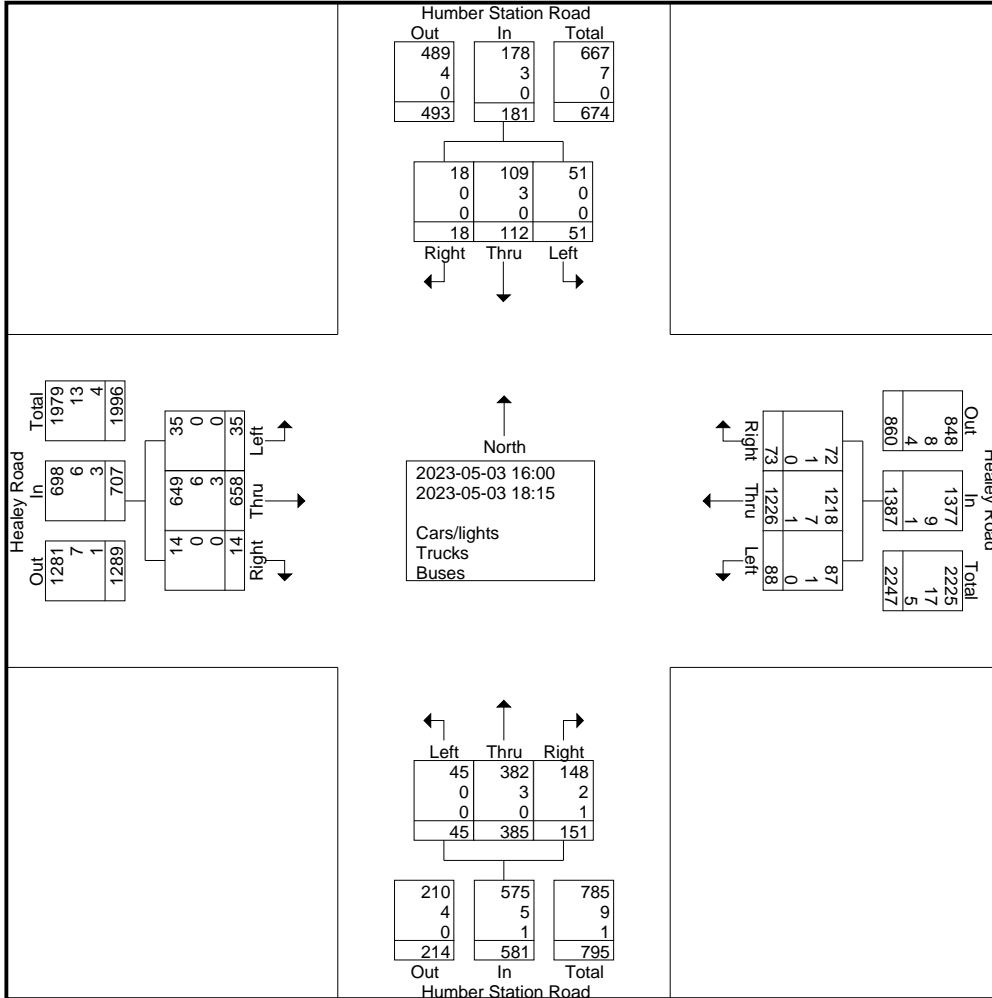

LEA Consulting Ltd.

625 Cochrane Drive, 5th Floor
Markham, ON L3R 9R9

File Name : Humber Station Rd & Healey Rd - PM
Site Code : 00023347
Start Date : 2023-05-03
Page No : 3

Start Time	Humber Station Road Southbound				Healey Road Westbound				Humber Station Road Northbound				Healey Road Eastbound				Int. Total
	Left	Thru	Right	App. Total	Left	Thru	Right	App. Total	Left	Thru	Right	App. Total	Left	Thru	Right	App. Total	
Peak Hour Analysis From 16:00 to 18:15 - Peak 1 of 1																	
Peak Hour for Entire Intersection Begins at 17:00																	
17:00	4	14	3	21	10	124	6	140	5	53	20	78	9	51	1	61	300
17:15	6	13	3	22	5	132	6	143	1	44	15	60	1	64	1	66	291
17:30	8	7	0	15	10	123	5	138	6	35	13	54	4	62	2	68	275
17:45	4	8	0	12	9	117	5	131	4	55	17	76	7	70	2	79	298
Total Volume	22	42	6	70	34	496	22	552	16	187	65	268	21	247	6	274	1164
% App. Total	31.4	60	8.6		6.2	89.9	4		6	69.8	24.3		7.7	90.1	2.2		
PHF	.688	.750	.500	.795	.850	.939	.917	.965	.667	.850	.813	.859	.583	.882	.750	.867	.970
Cars/lights	22	41	6	69	33	494	21	548	16	184	63	263	21	244	6	271	1151
% Cars/lights	100	97.6	100	98.6	97.1	99.6	95.5	99.3	100	98.4	96.9	98.1	100	98.8	100	98.9	98.9
Trucks	0	1	0	1	1	2	1	4	0	3	1	4	0	2	0	2	11
% Trucks	0	2.4	0	1.4	2.9	0.4	4.5	0.7	0	1.6	1.5	1.5	0	0.8	0	0.7	0.9
Buses	0	0	0	0	0	0	0	0	0	0	1	1	0	1	0	1	2
% Buses	0	0	0	0	0	0	0	0	0	0	1.5	0.4	0	0.4	0	0.4	0.2

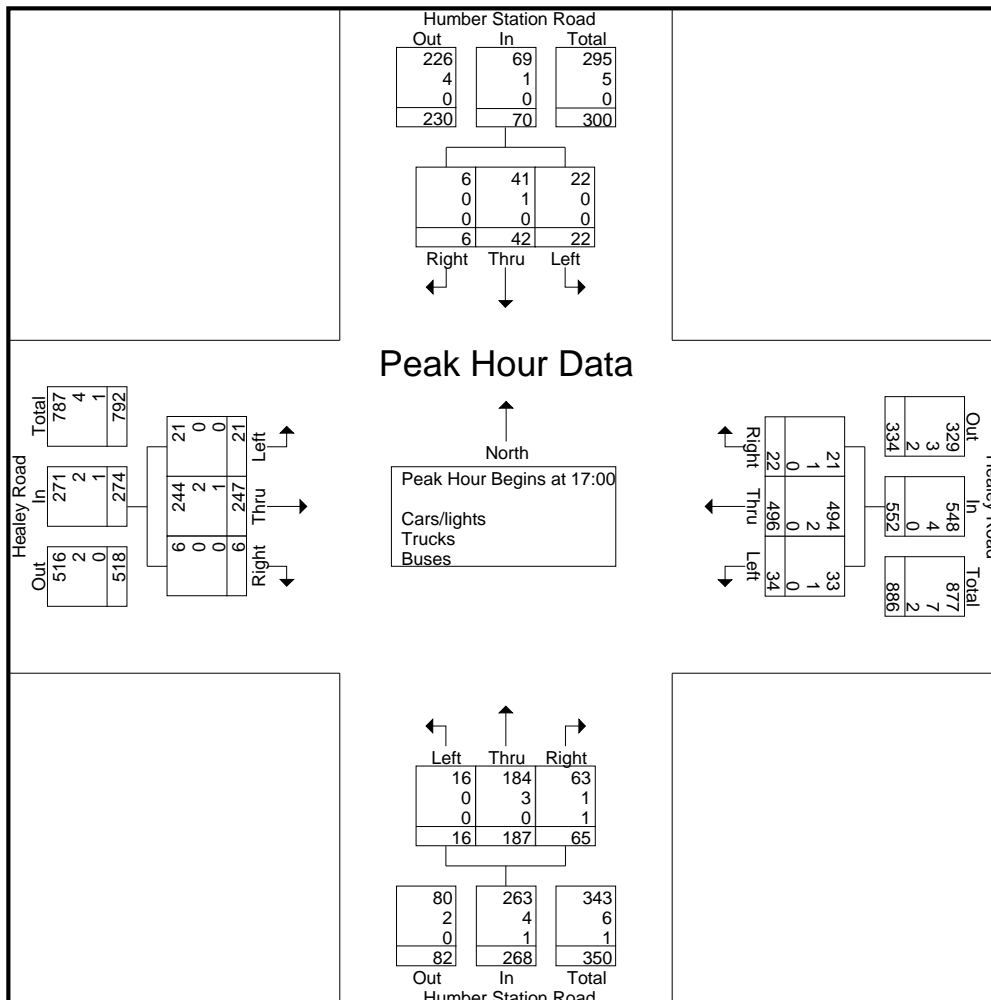

LEA Consulting Ltd.

625 Cochrane Drive, 5th Floor
Markham, ON L3R 9R9



LEA Consulting Ltd.
625 Cochrane Drive

Markam, Ontario, Canada L3R 9R9
905-470-0015 x240 idinsmore@lea.ca

Count Name: 23347_Humber Station Rd &
Mayfield Rd-AM
Site Code: 23347
Start Date: 05/03/2023
Page No: 1

Turning Movement Data

Start Time	Humber Station Road Southbound						Mayfield Road Westbound						Humber Station Road Northbound						Mayfield Road Eastbound						Int. Total
	Right	Thru	Left	U-Turn	Peds	App. Total	Right	Thru	Left	U-Turn	Peds	App. Total	Right	Thru	Left	U-Turn	Peds	App. Total	Right	Thru	Left	U-Turn	Peds	App. Total	
7:00 AM	5	55	1	0	0	61	1	104	23	0	0	128	41	9	2	0	0	52	4	131	0	0	0	135	376
7:15 AM	0	52	0	0	0	52	0	99	18	0	0	117	25	13	2	0	0	40	4	155	1	0	0	160	369
7:30 AM	1	77	0	0	0	78	1	88	13	0	0	102	21	13	5	0	0	39	10	98	2	0	0	110	329
7:45 AM	2	63	1	0	0	66	2	92	13	0	0	107	25	12	2	0	0	39	10	139	5	0	0	154	366
Hourly Total	8	247	2	0	0	257	4	383	67	0	0	454	112	47	11	0	0	170	28	523	8	0	0	559	1440
8:00 AM	4	51	0	0	0	55	0	75	19	0	0	94	17	16	4	0	0	37	17	140	2	0	0	159	345
8:15 AM	3	77	0	0	0	80	0	82	11	0	0	93	15	11	2	0	0	28	16	129	1	0	0	146	347
8:30 AM	5	53	0	0	0	58	4	71	28	0	0	103	22	17	3	0	0	42	12	110	0	0	0	122	325
8:45 AM	2	27	3	0	0	32	0	77	15	0	0	92	24	7	3	0	0	34	11	128	1	0	0	140	298
Hourly Total	14	208	3	0	0	225	4	305	73	0	0	382	78	51	12	0	0	141	56	507	4	0	0	567	1315
9:00 AM	1	28	0	0	0	29	1	80	5	0	0	86	17	17	7	0	0	41	6	127	2	0	0	135	291
9:15 AM	2	35	1	0	0	38	2	56	6	0	0	64	7	7	1	0	0	15	6	107	5	0	0	118	235
9:30 AM	0	0	0	0	0	0	0	0	0	0	0	0	0	0	0	0	0	0	0	0	0	0	0	0	0
Grand Total	25	518	6	0	0	549	11	824	151	0	0	986	214	122	31	0	0	367	96	1264	19	0	0	1379	3281
Approach %	4.6	94.4	1.1	0.0	-	-	1.1	83.6	15.3	0.0	-	-	58.3	33.2	8.4	0.0	-	-	7.0	91.7	1.4	0.0	-	-	-
Total %	0.8	15.8	0.2	0.0	-	16.7	0.3	25.1	4.6	0.0	-	30.1	6.5	3.7	0.9	0.0	-	11.2	2.9	38.5	0.6	0.0	-	42.0	-
Lights	20	515	4	0	-	539	8	606	138	0	-	752	208	117	23	0	-	348	84	1017	18	0	-	1119	2758
% Lights	80.0	99.4	66.7	-	-	98.2	72.7	73.5	91.4	-	-	76.3	97.2	95.9	74.2	-	-	94.8	87.5	80.5	94.7	-	-	81.1	84.1
Buses	2	1	1	0	-	4	1	3	1	0	-	5	0	3	3	0	-	6	0	11	1	0	-	12	27
% Buses	8.0	0.2	16.7	-	-	0.7	9.1	0.4	0.7	-	-	0.5	0.0	2.5	9.7	-	-	1.6	0.0	0.9	5.3	-	-	0.9	0.8
Trucks	3	2	1	0	-	6	2	215	12	0	-	229	6	2	5	0	-	13	12	236	0	0	-	248	496
% Trucks	12.0	0.4	16.7	-	-	1.1	18.2	26.1	7.9	-	-	23.2	2.8	1.6	16.1	-	-	3.5	12.5	18.7	0.0	-	-	18.0	15.1
Bicycles on Road	0	0	0	0	-	0	0	0	0	0	-	0	0	0	0	0	-	0	0	0	0	0	-	0	0
% Bicycles on Road	0.0	0.0	0.0	-	-	0.0	0.0	0.0	0.0	-	-	0.0	0.0	0.0	0.0	-	-	0.0	0.0	0.0	0.0	-	-	0.0	0.0
Bicycles on Crosswalk	-	-	-	-	0	-	-	-	-	-	0	-	-	-	-	-	0	-	-	-	-	-	0	-	-
% Bicycles on Crosswalk	-	-	-	-	-	-	-	-	-	-	-	-	-	-	-	-	-	-	-	-	-	-	-	-	-
Pedestrians	-	-	-	-	0	-	-	-	-	-	0	-	-	-	-	-	0	-	-	-	-	-	0	-	-
% Pedestrians	-	-	-	-	-	-	-	-	-	-	-	-	-	-	-	-	-	-	-	-	-	-	-	-	-



LEA Consulting Ltd.
625 Cochrane Drive

Markam, Ontario, Canada L3R 9R9
905-470-0015 x240 idinsmore@lea.ca

Count Name: 23347_Humber Station Rd &
Mayfield Rd-AM
Site Code: 23347
Start Date: 05/03/2023
Page No: 2

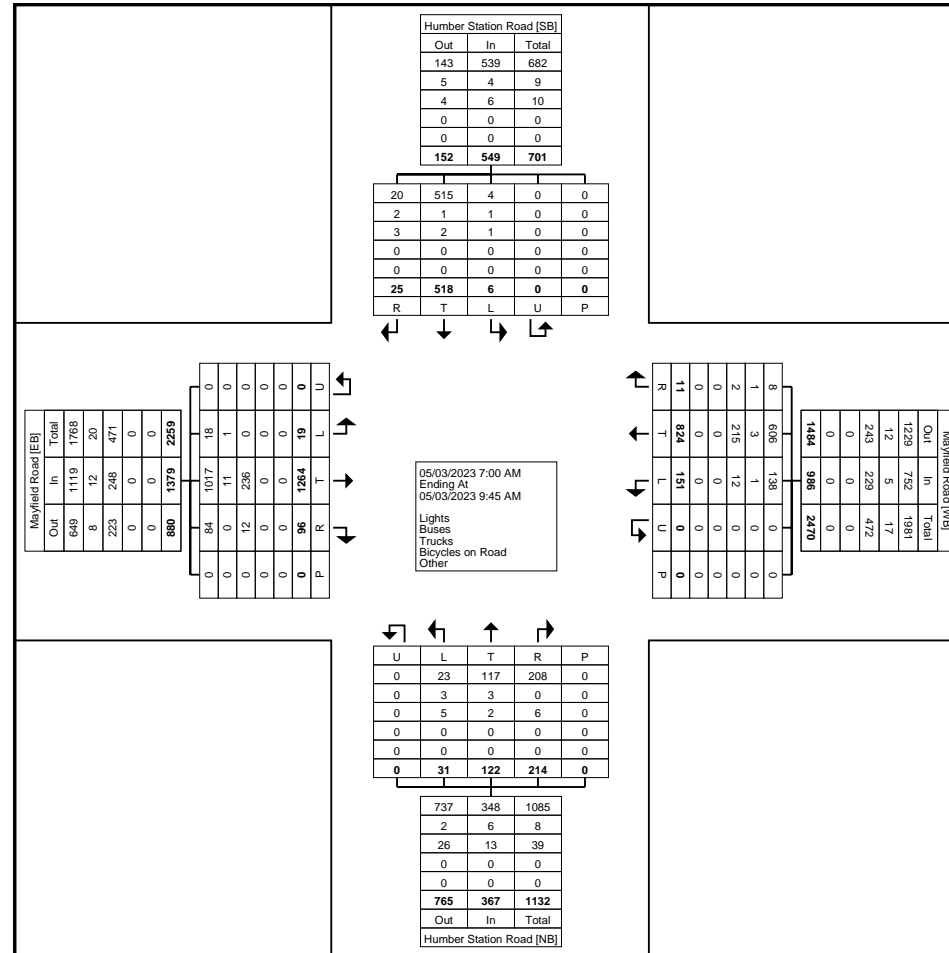

Turning Movement Data Plot



LEA Consulting Ltd.
625 Cochrane Drive

Markam, Ontario, Canada L3R 9R9
905-470-0015 x240 idinsmore@lea.ca

Count Name: 23347_Humber Station Rd &
Mayfield Rd-AM
Site Code: 23347
Start Date: 05/03/2023
Page No: 3

Turning Movement Peak Hour Data (7:00 AM)

Start Time	Humber Station Road Southbound						Mayfield Road Westbound						Humber Station Road Northbound						Mayfield Road Eastbound						Int. Total
	Right	Thru	Left	U-Turn	Peds	App. Total	Right	Thru	Left	U-Turn	Peds	App. Total	Right	Thru	Left	U-Turn	Peds	App. Total	Right	Thru	Left	U-Turn	Peds	App. Total	
7:00 AM	5	55	1	0	0	61	1	104	23	0	0	128	41	9	2	0	0	52	4	131	0	0	0	135	376
7:15 AM	0	52	0	0	0	52	0	99	18	0	0	117	25	13	2	0	0	40	4	155	1	0	0	160	369
7:30 AM	1	77	0	0	0	78	1	88	13	0	0	102	21	13	5	0	0	39	10	98	2	0	0	110	329
7:45 AM	2	63	1	0	0	66	2	92	13	0	0	107	25	12	2	0	0	39	10	139	5	0	0	154	366
Total	8	247	2	0	0	257	4	383	67	0	0	454	112	47	11	0	0	170	28	523	8	0	0	559	1440
Approach %	3.1	96.1	0.8	0.0	-	-	0.9	84.4	14.8	0.0	-	-	65.9	27.6	6.5	0.0	-	-	5.0	93.6	1.4	0.0	-	-	-
Total %	0.6	17.2	0.1	0.0	-	17.8	0.3	26.6	4.7	0.0	-	31.5	7.8	3.3	0.8	0.0	-	11.8	1.9	36.3	0.6	0.0	-	38.8	-
PHF	0.400	0.802	0.500	0.000	-	0.824	0.500	0.921	0.728	0.000	-	0.887	0.683	0.904	0.550	0.000	-	0.817	0.700	0.844	0.400	0.000	-	0.873	0.957
Lights	8	245	1	0	-	254	4	288	64	0	-	356	109	46	9	0	-	164	21	418	7	0	-	446	1220
% Lights	100.0	99.2	50.0	-	-	98.8	100.0	75.2	95.5	-	-	78.4	97.3	97.9	81.8	-	-	96.5	75.0	79.9	87.5	-	-	79.8	84.7
Buses	0	0	1	0	-	1	0	1	0	0	-	1	0	1	2	0	-	3	0	9	1	0	-	10	15
% Buses	0.0	0.0	50.0	-	-	0.4	0.0	0.3	0.0	-	-	0.2	0.0	2.1	18.2	-	-	1.8	0.0	1.7	12.5	-	-	1.8	1.0
Trucks	0	2	0	0	-	2	0	94	3	0	-	97	3	0	0	0	-	3	7	96	0	0	-	103	205
% Trucks	0.0	0.8	0.0	-	-	0.8	0.0	24.5	4.5	-	-	21.4	2.7	0.0	0.0	-	-	1.8	25.0	18.4	0.0	-	-	18.4	14.2
Bicycles on Road	0	0	0	0	-	0	0	0	0	0	-	0	0	0	0	0	-	0	0	0	0	0	-	0	0
% Bicycles on Road	0.0	0.0	0.0	-	-	0.0	0.0	0.0	0.0	-	-	0.0	0.0	0.0	0.0	-	-	0.0	0.0	0.0	0.0	-	-	0.0	0.0
Bicycles on Crosswalk	-	-	-	-	0	-	-	-	-	-	0	-	-	-	-	-	0	-	-	-	-	-	0	-	-
% Bicycles on Crosswalk	-	-	-	-	-	-	-	-	-	-	-	-	-	-	-	-	-	-	-	-	-	-	-	-	-
Pedestrians	-	-	-	-	0	-	-	-	-	-	0	-	-	-	-	-	0	-	-	-	-	-	0	-	-
% Pedestrians	-	-	-	-	-	-	-	-	-	-	-	-	-	-	-	-	-	-	-	-	-	-	-	-	-



LEA Consulting Ltd.
625 Cochrane Drive

Markam, Ontario, Canada L3R 9R9
905-470-0015 x240 idinsmore@lea.ca

Count Name: 23347_Humber Station Rd &
Mayfield Rd-AM
Site Code: 23347
Start Date: 05/03/2023
Page No: 4

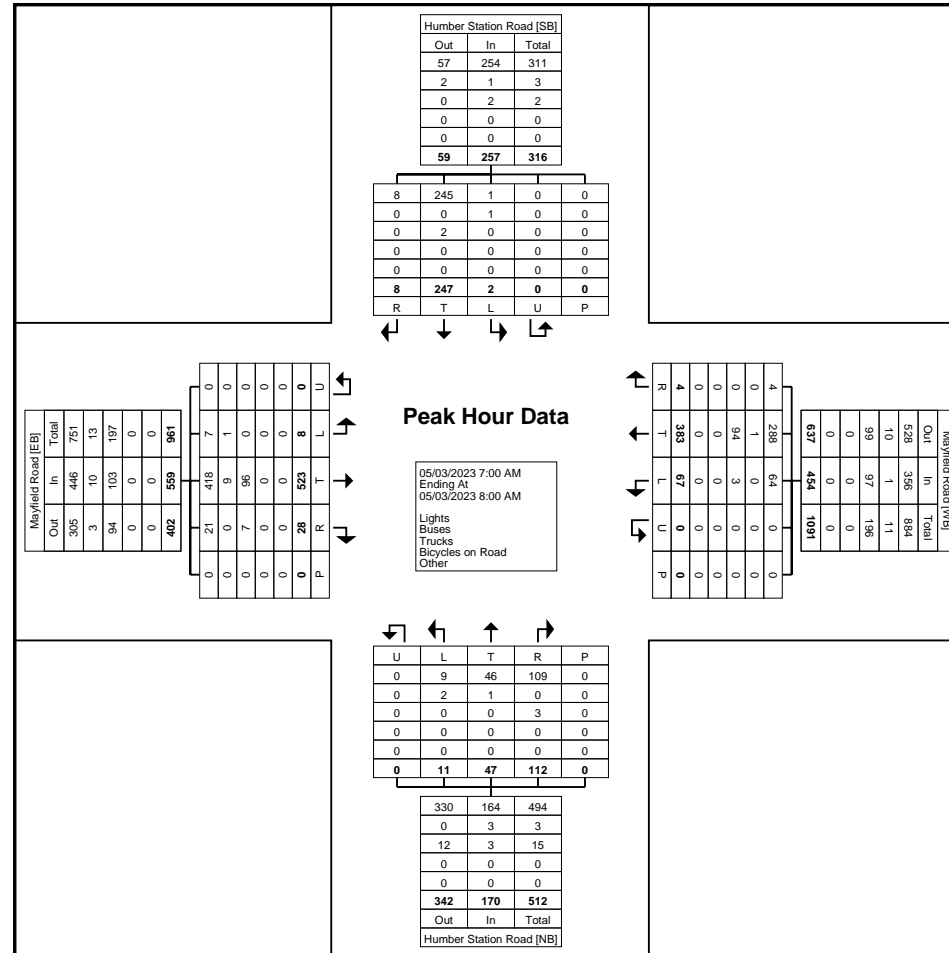

Turning Movement Peak Hour Data Plot (7:00 AM)



LEA Consulting Ltd.
625 Cochrane Drive

Markam, Ontario, Canada L3R 9R9
905-470-0015 x240 idinsmore@lea.ca

Count Name: 23347_Humber Station Rd &
Mayfield Rd-PM
Site Code: 23347
Start Date: 05/03/2023
Page No: 1

Turning Movement Data

Start Time	Humber Station Road Southbound						Mayfield Road Westbound						Humber Station Road Northbound						Mayfield Road Eastbound						Int. Total
	Right	Thru	Left	U-Turn	Peds	App. Total	Right	Thru	Left	U-Turn	Peds	App. Total	Right	Thru	Left	U-Turn	Peds	App. Total	Right	Thru	Left	U-Turn	Peds	App. Total	
4:00 PM	4	26	0	0	0	30	1	112	8	0	0	121	30	60	10	0	0	100	3	87	1	0	0	91	342
4:15 PM	2	26	2	0	0	30	1	122	11	0	0	134	20	50	7	0	0	77	7	99	0	0	0	106	347
4:30 PM	2	20	1	0	0	23	0	72	16	0	0	88	20	58	8	0	0	86	7	108	0	0	0	115	312
4:45 PM	2	12	1	0	0	15	0	93	20	0	0	113	24	63	16	0	0	103	6	112	0	0	0	118	349
Hourly Total	10	84	4	0	0	98	2	399	55	0	0	456	94	231	41	0	0	366	23	406	1	0	0	430	1350
5:00 PM	1	15	0	0	0	16	0	79	17	0	0	96	34	73	13	0	0	120	6	110	1	0	0	117	349
5:15 PM	5	18	0	0	0	23	0	115	19	0	0	134	31	48	15	0	0	94	4	108	2	0	0	114	365
5:30 PM	4	18	0	0	0	22	3	108	6	0	0	117	25	69	22	0	0	116	5	99	1	0	0	105	360
5:45 PM	2	11	0	0	0	13	1	127	10	0	0	138	19	55	9	0	0	83	4	131	6	0	0	141	375
Hourly Total	12	62	0	0	0	74	4	429	52	0	0	485	109	245	59	0	0	413	19	448	10	0	0	477	1449
6:00 PM	2	16	1	0	0	19	2	94	17	0	0	113	29	61	10	0	0	100	3	108	2	0	0	113	345
6:15 PM	5	20	2	0	0	27	3	128	22	0	0	153	31	28	9	0	0	68	4	108	1	0	0	113	361
6:30 PM	0	0	0	0	0	0	0	0	0	0	0	0	0	0	0	0	0	0	0	0	0	0	0	0	0
Grand Total	29	182	7	0	0	218	11	1050	146	0	0	1207	263	565	119	0	0	947	49	1070	14	0	0	1133	3505
Approach %	13.3	83.5	3.2	0.0	-	-	0.9	87.0	12.1	0.0	-	-	27.8	59.7	12.6	0.0	-	-	4.3	94.4	1.2	0.0	-	-	-
Total %	0.8	5.2	0.2	0.0	-	6.2	0.3	30.0	4.2	0.0	-	34.4	7.5	16.1	3.4	0.0	-	27.0	1.4	30.5	0.4	0.0	-	32.3	-
Lights	29	179	7	0	-	215	9	875	137	0	-	1021	254	560	99	0	-	913	42	895	11	0	-	948	3097
% Lights	100.0	98.4	100.0	-	-	98.6	81.8	83.3	93.8	-	-	84.6	96.6	99.1	83.2	-	-	96.4	85.7	83.6	78.6	-	-	83.7	88.4
Buses	0	2	0	0	-	2	1	4	0	0	-	5	0	0	0	0	-	0	1	3	1	0	-	5	12
% Buses	0.0	1.1	0.0	-	-	0.9	9.1	0.4	0.0	-	-	0.4	0.0	0.0	0.0	-	-	0.0	2.0	0.3	7.1	-	-	0.4	0.3
Trucks	0	1	0	0	-	1	1	171	9	0	-	181	9	5	20	0	-	34	6	172	2	0	-	180	396
% Trucks	0.0	0.5	0.0	-	-	0.5	9.1	16.3	6.2	-	-	15.0	3.4	0.9	16.8	-	-	3.6	12.2	16.1	14.3	-	-	15.9	11.3
Bicycles on Road	0	0	0	0	-	0	0	0	0	0	-	0	0	0	0	0	-	0	0	0	0	0	-	0	0
% Bicycles on Road	0.0	0.0	0.0	-	-	0.0	0.0	0.0	0.0	-	-	0.0	0.0	0.0	0.0	-	-	0.0	0.0	0.0	0.0	-	-	0.0	0.0
Bicycles on Crosswalk	-	-	-	-	0	-	-	-	-	-	0	-	-	-	-	-	0	-	-	-	-	-	0	-	-
% Bicycles on Crosswalk	-	-	-	-	-	-	-	-	-	-	-	-	-	-	-	-	-	-	-	-	-	-	-	-	-
Pedestrians	-	-	-	-	0	-	-	-	-	-	0	-	-	-	-	-	0	-	-	-	-	-	0	-	-
% Pedestrians	-	-	-	-	-	-	-	-	-	-	-	-	-	-	-	-	-	-	-	-	-	-	-	-	-



LEA Consulting Ltd.
625 Cochrane Drive

Markam, Ontario, Canada L3R 9R9
905-470-0015 x240 idinsmore@lea.ca

Count Name: 23347_Humber Station Rd &
Mayfield Rd-PM
Site Code: 23347
Start Date: 05/03/2023
Page No: 2

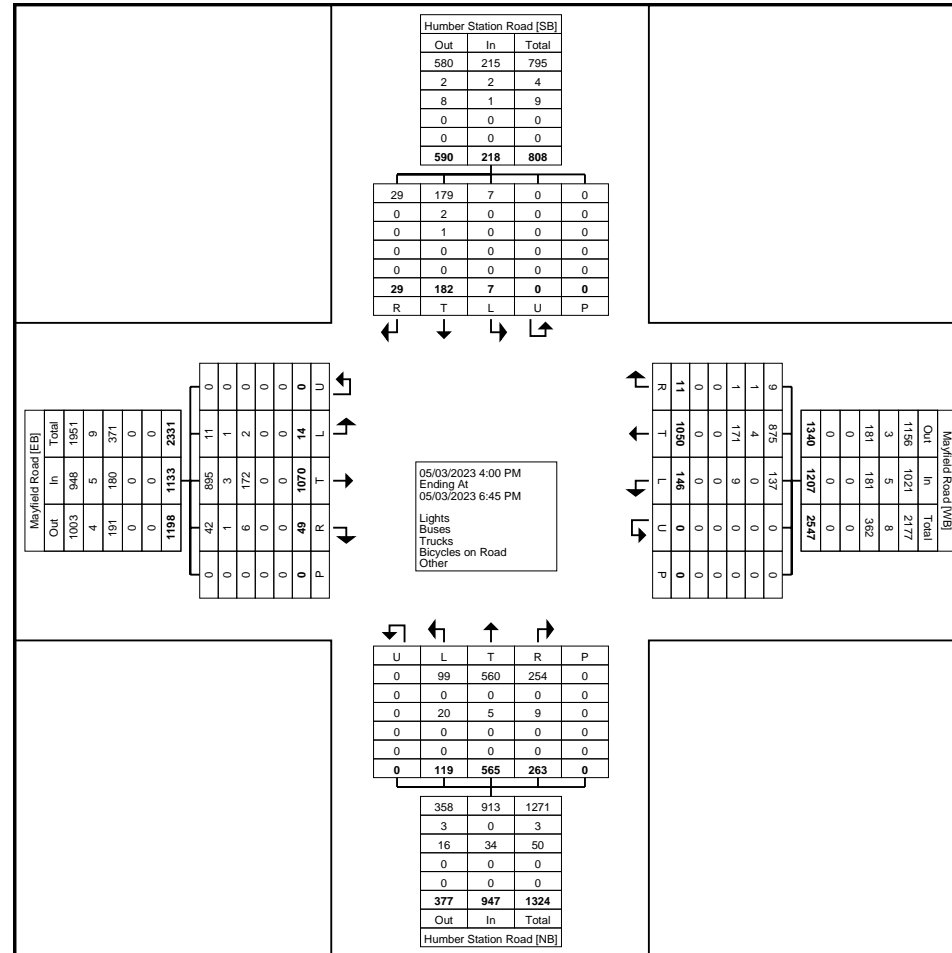

Turning Movement Data Plot



LEA Consulting Ltd.
625 Cochrane Drive

Markam, Ontario, Canada L3R 9R9
905-470-0015 x240 idinsmore@lea.ca

Count Name: 23347_Humber Station Rd &
Mayfield Rd-PM
Site Code: 23347
Start Date: 05/03/2023
Page No: 3

Turning Movement Peak Hour Data (5:00 PM)

Start Time	Humber Station Road Southbound						Mayfield Road Westbound						Humber Station Road Northbound						Mayfield Road Eastbound						Int. Total
	Right	Thru	Left	U-Turn	Peds	App. Total	Right	Thru	Left	U-Turn	Peds	App. Total	Right	Thru	Left	U-Turn	Peds	App. Total	Right	Thru	Left	U-Turn	Peds	App. Total	
5:00 PM	1	15	0	0	0	16	0	79	17	0	0	96	34	73	13	0	0	120	6	110	1	0	0	117	349
5:15 PM	5	18	0	0	0	23	0	115	19	0	0	134	31	48	15	0	0	94	4	108	2	0	0	114	365
5:30 PM	4	18	0	0	0	22	3	108	6	0	0	117	25	69	22	0	0	116	5	99	1	0	0	105	360
5:45 PM	2	11	0	0	0	13	1	127	10	0	0	138	19	55	9	0	0	83	4	131	6	0	0	141	375
Total	12	62	0	0	0	74	4	429	52	0	0	485	109	245	59	0	0	413	19	448	10	0	0	477	1449
Approach %	16.2	83.8	0.0	0.0	-	-	0.8	88.5	10.7	0.0	-	-	26.4	59.3	14.3	0.0	-	-	4.0	93.9	2.1	0.0	-	-	-
Total %	0.8	4.3	0.0	0.0	-	5.1	0.3	29.6	3.6	0.0	-	33.5	7.5	16.9	4.1	0.0	-	28.5	1.3	30.9	0.7	0.0	-	32.9	-
PHF	0.600	0.861	0.000	0.000	-	0.804	0.333	0.844	0.684	0.000	-	0.879	0.801	0.839	0.670	0.000	-	0.860	0.792	0.855	0.417	0.000	-	0.846	0.966
Lights	12	61	0	0	-	73	4	358	51	0	-	413	108	241	52	0	-	401	17	379	8	0	-	404	1291
% Lights	100.0	98.4	-	-	-	98.6	100.0	83.4	98.1	-	-	85.2	99.1	98.4	88.1	-	-	97.1	89.5	84.6	80.0	-	-	84.7	89.1
Buses	0	0	0	0	-	0	0	0	0	0	-	0	0	0	0	0	-	0	0	0	1	0	-	1	1
% Buses	0.0	0.0	-	-	-	0.0	0.0	0.0	0.0	-	-	0.0	0.0	0.0	0.0	-	-	0.0	0.0	0.0	10.0	-	-	0.2	0.1
Trucks	0	1	0	0	-	1	0	71	1	0	-	72	1	4	7	0	-	12	2	69	1	0	-	72	157
% Trucks	0.0	1.6	-	-	-	1.4	0.0	16.6	1.9	-	-	14.8	0.9	1.6	11.9	-	-	2.9	10.5	15.4	10.0	-	-	15.1	10.8
Bicycles on Road	0	0	0	0	-	0	0	0	0	0	-	0	0	0	0	0	-	0	0	0	0	0	-	0	0
% Bicycles on Road	0.0	0.0	-	-	-	0.0	0.0	0.0	0.0	-	-	0.0	0.0	0.0	0.0	-	-	0.0	0.0	0.0	0.0	-	-	0.0	0.0
Bicycles on Crosswalk	-	-	-	-	0	-	-	-	-	-	0	-	-	-	-	-	0	-	-	-	-	-	0	-	-
% Bicycles on Crosswalk	-	-	-	-	-	-	-	-	-	-	-	-	-	-	-	-	-	-	-	-	-	-	-	-	-
Pedestrians	-	-	-	-	0	-	-	-	-	-	0	-	-	-	-	-	0	-	-	-	-	-	0	-	-
% Pedestrians	-	-	-	-	-	-	-	-	-	-	-	-	-	-	-	-	-	-	-	-	-	-	-	-	-



LEA Consulting Ltd.
625 Cochrane Drive

Markam, Ontario, Canada L3R 9R9
905-470-0015 x240 idinsmore@lea.ca

Count Name: 23347_Humber Station Rd &
Mayfield Rd-PM
Site Code: 23347
Start Date: 05/03/2023
Page No: 4

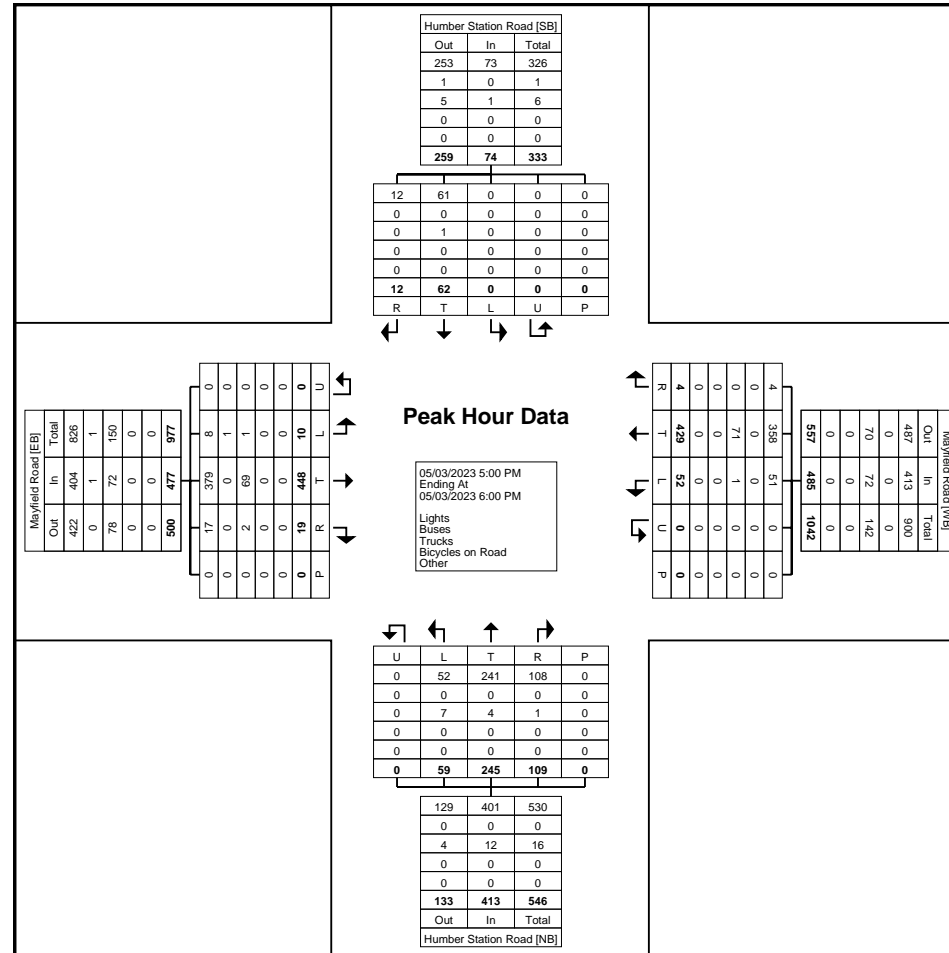

Turning Movement Peak Hour Data Plot (5:00 PM)



LEA Consulting Ltd.
625 Cochrane Drive

Markam, Ontario, Canada L3R 9R9
905-470-0015 x240 idinsmore@lea.ca

Count Name: 23347_Coleraine Dr & George
Bolton Pkwy-AM
Site Code: 23347
Start Date: 05/03/2023
Page No: 1

Turning Movement Data

Start Time	Coleraine Drive Southbound						George Bolton Parkway Westbound						Coleraine Drive Northbound						George Bolton Parkway Eastbound						Int. Total
	Right	Thru	Left	U-Turn	Peds	App. Total	Right	Thru	Left	U-Turn	Peds	App. Total	Right	Thru	Left	U-Turn	Peds	App. Total	Right	Thru	Left	U-Turn	Peds	App. Total	
7:00 AM	1	74	23	0	0	98	52	4	14	0	0	70	28	87	4	0	0	119	7	5	2	0	0	14	301
7:15 AM	4	60	21	0	0	85	42	4	19	0	0	65	19	117	6	0	0	142	3	3	1	0	0	7	299
7:30 AM	1	68	23	0	0	92	23	7	22	0	0	52	20	40	10	0	0	70	1	1	0	0	0	2	216
7:45 AM	5	78	17	0	0	100	24	8	8	0	0	40	29	34	10	0	0	73	2	3	1	0	0	6	219
Hourly Total	11	280	84	0	0	375	141	23	63	0	0	227	96	278	30	0	0	404	13	12	4	0	0	29	1035
8:00 AM	2	57	23	0	0	82	20	4	6	0	0	30	32	50	7	0	0	89	2	7	0	0	0	9	210
8:15 AM	0	71	19	0	0	90	16	6	13	0	0	35	33	51	4	0	0	88	2	3	0	0	0	5	218
8:30 AM	1	61	20	0	0	82	22	4	12	0	0	38	25	28	5	0	0	58	3	2	3	0	0	8	186
8:45 AM	4	62	16	0	0	82	20	4	11	0	0	35	22	38	8	0	0	68	4	6	2	0	0	12	197
Hourly Total	7	251	78	0	0	336	78	18	42	0	0	138	112	167	24	0	0	303	11	18	5	0	0	34	811
9:00 AM	1	57	15	0	0	73	20	13	17	0	0	50	20	39	10	0	0	69	1	4	0	0	0	5	197
9:15 AM	2	56	15	0	0	73	25	3	17	0	0	45	22	28	2	0	0	52	4	3	0	0	0	7	177
9:30 AM	0	0	0	0	0	0	0	0	0	0	0	0	0	0	0	0	0	0	0	0	0	0	0	0	0
Grand Total	21	644	192	0	0	857	264	57	139	0	0	460	250	512	66	0	0	828	29	37	9	0	0	75	2220
Approach %	2.5	75.1	22.4	0.0	-	-	57.4	12.4	30.2	0.0	-	-	30.2	61.8	8.0	0.0	-	-	38.7	49.3	12.0	0.0	-	-	-
Total %	0.9	29.0	8.6	0.0	-	38.6	11.9	2.6	6.3	0.0	-	20.7	11.3	23.1	3.0	0.0	-	37.3	1.3	1.7	0.4	0.0	-	3.4	-
Lights	18	476	173	0	-	667	228	41	106	0	-	375	197	358	47	0	-	602	15	22	6	0	-	43	1687
% Lights	85.7	73.9	90.1	-	-	77.8	86.4	71.9	76.3	-	-	81.5	78.8	69.9	71.2	-	-	72.7	51.7	59.5	66.7	-	-	57.3	76.0
Buses	0	5	1	0	-	6	1	0	1	0	-	2	2	3	0	0	-	5	0	0	0	0	-	0	13
% Buses	0.0	0.8	0.5	-	-	0.7	0.4	0.0	0.7	-	-	0.4	0.8	0.6	0.0	-	-	0.6	0.0	0.0	0.0	-	-	0.0	0.6
Trucks	3	163	18	0	-	184	35	16	32	0	-	83	51	151	19	0	-	221	14	15	3	0	-	32	520
% Trucks	14.3	25.3	9.4	-	-	21.5	13.3	28.1	23.0	-	-	18.0	20.4	29.5	28.8	-	-	26.7	48.3	40.5	33.3	-	-	42.7	23.4
Bicycles on Road	0	0	0	0	-	0	0	0	0	0	-	0	0	0	0	0	-	0	0	0	0	0	-	0	0
% Bicycles on Road	0.0	0.0	0.0	-	-	0.0	0.0	0.0	0.0	-	-	0.0	0.0	0.0	0.0	-	-	0.0	0.0	0.0	0.0	-	-	0.0	0.0
Bicycles on Crosswalk	-	-	-	-	0	-	-	-	-	-	0	-	-	-	-	-	0	-	-	-	-	-	0	-	-
% Bicycles on Crosswalk	-	-	-	-	-	-	-	-	-	-	-	-	-	-	-	-	-	-	-	-	-	-	-	-	-
Pedestrians	-	-	-	-	0	-	-	-	-	-	0	-	-	-	-	-	0	-	-	-	-	-	0	-	-
% Pedestrians	-	-	-	-	-	-	-	-	-	-	-	-	-	-	-	-	-	-	-	-	-	-	-	-	-



LEA Consulting Ltd.
625 Cochrane Drive

Markam, Ontario, Canada L3R 9R9
905-470-0015 x240 idinsmore@lea.ca

Count Name: 23347_Coleraine Dr & George
Bolton Pkwy-AM
Site Code: 23347
Start Date: 05/03/2023
Page No: 3

Turning Movement Peak Hour Data (7:00 AM)

Start Time	Coleraine Drive Southbound						George Bolton Parkway Westbound						Coleraine Drive Northbound						George Bolton Parkway Eastbound						Int. Total
	Right	Thru	Left	U-Turn	Peds	App. Total	Right	Thru	Left	U-Turn	Peds	App. Total	Right	Thru	Left	U-Turn	Peds	App. Total	Right	Thru	Left	U-Turn	Peds	App. Total	
7:00 AM	1	74	23	0	0	98	52	4	14	0	0	70	28	87	4	0	0	119	7	5	2	0	0	14	301
7:15 AM	4	60	21	0	0	85	42	4	19	0	0	65	19	117	6	0	0	142	3	3	1	0	0	7	299
7:30 AM	1	68	23	0	0	92	23	7	22	0	0	52	20	40	10	0	0	70	1	1	0	0	0	2	216
7:45 AM	5	78	17	0	0	100	24	8	8	0	0	40	29	34	10	0	0	73	2	3	1	0	0	6	219
Total	11	280	84	0	0	375	141	23	63	0	0	227	96	278	30	0	0	404	13	12	4	0	0	29	1035
Approach %	2.9	74.7	22.4	0.0	-	-	62.1	10.1	27.8	0.0	-	-	23.8	68.8	7.4	0.0	-	-	44.8	41.4	13.8	0.0	-	-	-
Total %	1.1	27.1	8.1	0.0	-	36.2	13.6	2.2	6.1	0.0	-	21.9	9.3	26.9	2.9	0.0	-	39.0	1.3	1.2	0.4	0.0	-	2.8	-
PHF	0.550	0.897	0.913	0.000	-	0.938	0.678	0.719	0.716	0.000	-	0.811	0.828	0.594	0.750	0.000	-	0.711	0.464	0.600	0.500	0.000	-	0.518	0.860
Lights	10	220	79	0	-	309	126	13	42	0	-	181	78	227	23	0	-	328	9	7	4	0	-	20	838
% Lights	90.9	78.6	94.0	-	-	82.4	89.4	56.5	66.7	-	-	79.7	81.3	81.7	76.7	-	-	81.2	69.2	58.3	100.0	-	-	69.0	81.0
Buses	0	0	0	0	-	0	1	0	0	0	-	1	0	2	0	0	-	2	0	0	0	0	-	0	3
% Buses	0.0	0.0	0.0	-	-	0.0	0.7	0.0	0.0	-	-	0.4	0.0	0.7	0.0	-	-	0.5	0.0	0.0	0.0	-	-	0.0	0.3
Trucks	1	60	5	0	-	66	14	10	21	0	-	45	18	49	7	0	-	74	4	5	0	0	-	9	194
% Trucks	9.1	21.4	6.0	-	-	17.6	9.9	43.5	33.3	-	-	19.8	18.8	17.6	23.3	-	-	18.3	30.8	41.7	0.0	-	-	31.0	18.7
Bicycles on Road	0	0	0	0	-	0	0	0	0	0	-	0	0	0	0	0	-	0	0	0	0	0	-	0	0
% Bicycles on Road	0.0	0.0	0.0	-	-	0.0	0.0	0.0	0.0	-	-	0.0	0.0	0.0	0.0	-	-	0.0	0.0	0.0	0.0	-	-	0.0	0.0
Bicycles on Crosswalk	-	-	-	-	0	-	-	-	-	-	0	-	-	-	-	-	0	-	-	-	-	-	0	-	-
% Bicycles on Crosswalk	-	-	-	-	-	-	-	-	-	-	-	-	-	-	-	-	-	-	-	-	-	-	-	-	-
Pedestrians	-	-	-	-	0	-	-	-	-	-	0	-	-	-	-	-	0	-	-	-	-	-	0	-	-
% Pedestrians	-	-	-	-	-	-	-	-	-	-	-	-	-	-	-	-	-	-	-	-	-	-	-	-	-



LEA Consulting Ltd.
625 Cochrane Drive

Markam, Ontario, Canada L3R 9R9
905-470-0015 x240 idinsmore@lea.ca

Count Name: 23347_Coleraine Dr & George
Bolton Pkwy-AM
Site Code: 23347
Start Date: 05/03/2023
Page No: 4

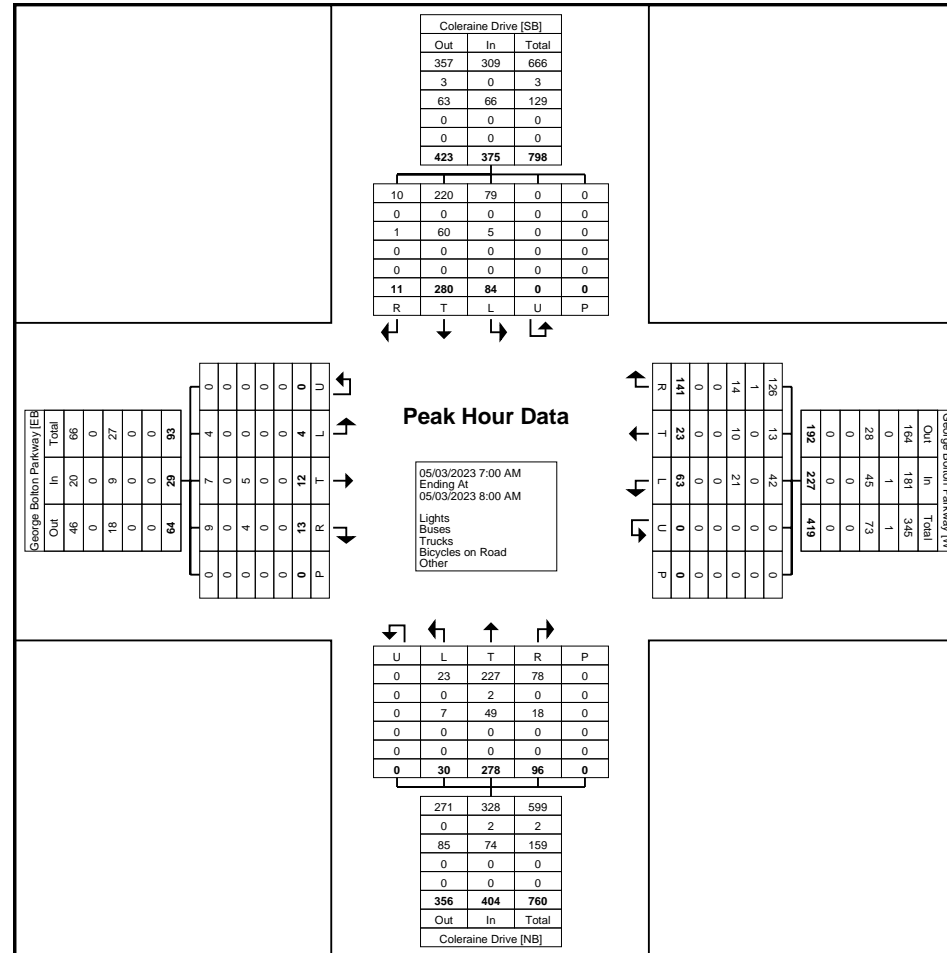

Turning Movement Peak Hour Data Plot (7:00 AM)



LEA Consulting Ltd.
625 Cochrane Drive

Markam, Ontario, Canada L3R 9R9
905-470-0015 x240 idinsmore@lea.ca

Count Name: 23347_Coleraine Dr & George
Bolton Pkwy-PM
Site Code: 23347
Start Date: 05/03/2023
Page No: 1

Turning Movement Data

Start Time	Coleraine Drive Southbound						George Bolton Parkway Westbound						Coleraine Drive Northbound						George Bolton Parkway Eastbound						Int. Total
	Right	Thru	Left	U-Turn	Peds	App. Total	Right	Thru	Left	U-Turn	Peds	App. Total	Right	Thru	Left	U-Turn	Peds	App. Total	Right	Thru	Left	U-Turn	Peds	App. Total	
4:00 PM	0	111	21	0	0	132	32	2	28	0	0	62	25	55	1	0	0	81	5	5	1	0	0	11	286
4:15 PM	2	66	16	0	0	84	27	1	22	0	0	50	24	58	1	0	0	83	5	1	0	0	0	6	223
4:30 PM	0	47	20	0	0	67	31	1	29	0	0	61	24	58	1	0	0	83	9	7	2	0	0	18	229
4:45 PM	0	41	19	0	0	60	42	0	20	0	0	62	26	63	1	0	0	90	5	5	4	0	0	14	226
Hourly Total	2	265	76	0	0	343	132	4	99	0	0	235	99	234	4	0	0	337	24	18	7	0	0	49	964
5:00 PM	1	57	17	0	0	75	53	0	33	0	0	86	20	90	0	0	0	110	3	3	3	0	0	9	280
5:15 PM	0	62	17	0	0	79	45	1	19	0	0	65	20	96	3	0	0	119	2	8	2	0	0	12	275
5:30 PM	0	144	45	0	0	189	38	2	7	0	0	47	17	108	0	0	0	125	6	4	0	0	0	10	371
5:45 PM	1	70	35	0	0	106	32	3	24	0	0	59	11	96	2	0	0	109	11	11	5	0	0	27	301
Hourly Total	2	333	114	0	0	449	168	6	83	0	0	257	68	390	5	0	0	463	22	26	10	0	0	58	1227
6:00 PM	0	155	48	0	0	203	40	3	11	0	0	54	22	122	1	0	0	145	3	3	0	0	0	6	408
6:15 PM	1	66	16	0	0	83	40	2	12	0	0	54	15	113	1	0	0	129	1	1	1	0	0	3	269
6:30 PM	0	0	1	0	0	1	0	0	0	0	0	0	0	0	0	0	0	0	0	0	0	0	0	0	1
Grand Total	5	819	255	0	0	1079	380	15	205	0	0	600	204	859	11	0	0	1074	50	48	18	0	0	116	2869
Approach %	0.5	75.9	23.6	0.0	-	-	63.3	2.5	34.2	0.0	-	-	19.0	80.0	1.0	0.0	-	-	43.1	41.4	15.5	0.0	-	-	-
Total %	0.2	28.5	8.9	0.0	-	37.6	13.2	0.5	7.1	0.0	-	20.9	7.1	29.9	0.4	0.0	-	37.4	1.7	1.7	0.6	0.0	-	4.0	-
Lights	3	663	237	0	-	903	343	11	187	0	-	541	159	695	5	0	-	859	39	39	16	0	-	94	2397
% Lights	60.0	81.0	92.9	-	-	83.7	90.3	73.3	91.2	-	-	90.2	77.9	80.9	45.5	-	-	80.0	78.0	81.3	88.9	-	-	81.0	83.5
Buses	0	2	0	0	-	2	2	0	0	0	-	2	2	0	0	0	-	2	0	0	0	0	-	0	6
% Buses	0.0	0.2	0.0	-	-	0.2	0.5	0.0	0.0	-	-	0.3	1.0	0.0	0.0	-	-	0.2	0.0	0.0	0.0	-	-	0.0	0.2
Trucks	2	154	18	0	-	174	35	4	18	0	-	57	43	164	6	0	-	213	11	9	2	0	-	22	466
% Trucks	40.0	18.8	7.1	-	-	16.1	9.2	26.7	8.8	-	-	9.5	21.1	19.1	54.5	-	-	19.8	22.0	18.8	11.1	-	-	19.0	16.2
Bicycles on Road	0	0	0	0	-	0	0	0	0	0	-	0	0	0	0	0	-	0	0	0	0	0	-	0	0
% Bicycles on Road	0.0	0.0	0.0	-	-	0.0	0.0	0.0	0.0	-	-	0.0	0.0	0.0	0.0	-	-	0.0	0.0	0.0	0.0	-	-	0.0	0.0
Bicycles on Crosswalk	-	-	-	-	0	-	-	-	-	-	0	-	-	-	-	-	0	-	-	-	-	-	0	-	-
% Bicycles on Crosswalk	-	-	-	-	-	-	-	-	-	-	-	-	-	-	-	-	-	-	-	-	-	-	-	-	-
Pedestrians	-	-	-	-	0	-	-	-	-	-	0	-	-	-	-	-	0	-	-	-	-	-	0	-	-
% Pedestrians	-	-	-	-	-	-	-	-	-	-	-	-	-	-	-	-	-	-	-	-	-	-	-	-	-



LEA Consulting Ltd.
625 Cochrane Drive

Markam, Ontario, Canada L3R 9R9
905-470-0015 x240 idinsmore@lea.ca

Count Name: 23347_Coleraine Dr & George
Bolton Pkwy-PM
Site Code: 23347
Start Date: 05/03/2023
Page No: 3

Turning Movement Peak Hour Data (5:15 PM)

Start Time	Coleraine Drive Southbound						George Bolton Parkway Westbound						Coleraine Drive Northbound						George Bolton Parkway Eastbound						Int. Total
	Right	Thru	Left	U-Turn	Peds	App. Total	Right	Thru	Left	U-Turn	Peds	App. Total	Right	Thru	Left	U-Turn	Peds	App. Total	Right	Thru	Left	U-Turn	Peds	App. Total	
5:15 PM	0	62	17	0	0	79	45	1	19	0	0	65	20	96	3	0	0	119	2	8	2	0	0	12	275
5:30 PM	0	144	45	0	0	189	38	2	7	0	0	47	17	108	0	0	0	125	6	4	0	0	0	10	371
5:45 PM	1	70	35	0	0	106	32	3	24	0	0	59	11	96	2	0	0	109	11	11	5	0	0	27	301
6:00 PM	0	155	48	0	0	203	40	3	11	0	0	54	22	122	1	0	0	145	3	3	0	0	0	6	408
Total	1	431	145	0	0	577	155	9	61	0	0	225	70	422	6	0	0	498	22	26	7	0	0	55	1355
Approach %	0.2	74.7	25.1	0.0	-	-	68.9	4.0	27.1	0.0	-	-	14.1	84.7	1.2	0.0	-	-	40.0	47.3	12.7	0.0	-	-	-
Total %	0.1	31.8	10.7	0.0	-	42.6	11.4	0.7	4.5	0.0	-	16.6	5.2	31.1	0.4	0.0	-	36.8	1.6	1.9	0.5	0.0	-	4.1	-
PHF	0.250	0.695	0.755	0.000	-	0.711	0.861	0.750	0.635	0.000	-	0.865	0.795	0.865	0.500	0.000	-	0.859	0.500	0.591	0.350	0.000	-	0.509	0.830
Lights	1	378	138	0	-	517	142	8	53	0	-	203	60	364	3	0	-	427	19	25	7	0	-	51	1198
% Lights	100.0	87.7	95.2	-	-	89.6	91.6	88.9	86.9	-	-	90.2	85.7	86.3	50.0	-	-	85.7	86.4	96.2	100.0	-	-	92.7	88.4
Buses	0	0	0	0	-	0	0	0	0	0	-	0	0	0	0	0	-	0	0	0	0	0	-	0	0
% Buses	0.0	0.0	0.0	-	-	0.0	0.0	0.0	0.0	-	-	0.0	0.0	0.0	0.0	-	-	0.0	0.0	0.0	0.0	-	-	0.0	0.0
Trucks	0	53	7	0	-	60	13	1	8	0	-	22	10	58	3	0	-	71	3	1	0	0	-	4	157
% Trucks	0.0	12.3	4.8	-	-	10.4	8.4	11.1	13.1	-	-	9.8	14.3	13.7	50.0	-	-	14.3	13.6	3.8	0.0	-	-	7.3	11.6
Bicycles on Road	0	0	0	0	-	0	0	0	0	0	-	0	0	0	0	0	-	0	0	0	0	0	-	0	0
% Bicycles on Road	0.0	0.0	0.0	-	-	0.0	0.0	0.0	0.0	-	-	0.0	0.0	0.0	0.0	-	-	0.0	0.0	0.0	0.0	-	-	0.0	0.0
Bicycles on Crosswalk	-	-	-	-	0	-	-	-	-	-	0	-	-	-	-	-	0	-	-	-	-	-	0	-	-
% Bicycles on Crosswalk	-	-	-	-	-	-	-	-	-	-	-	-	-	-	-	-	-	-	-	-	-	-	-	-	-
Pedestrians	-	-	-	-	0	-	-	-	-	-	0	-	-	-	-	-	0	-	-	-	-	-	0	-	-
% Pedestrians	-	-	-	-	-	-	-	-	-	-	-	-	-	-	-	-	-	-	-	-	-	-	-	-	-



LEA Consulting Ltd.
625 Cochrane Drive

Markam, Ontario, Canada L3R 9R9
905-470-0015 x240 idinsmore@lea.ca

Count Name: 23347_Coleraine Dr & George
Bolton Pkwy-PM
Site Code: 23347
Start Date: 05/03/2023
Page No: 4

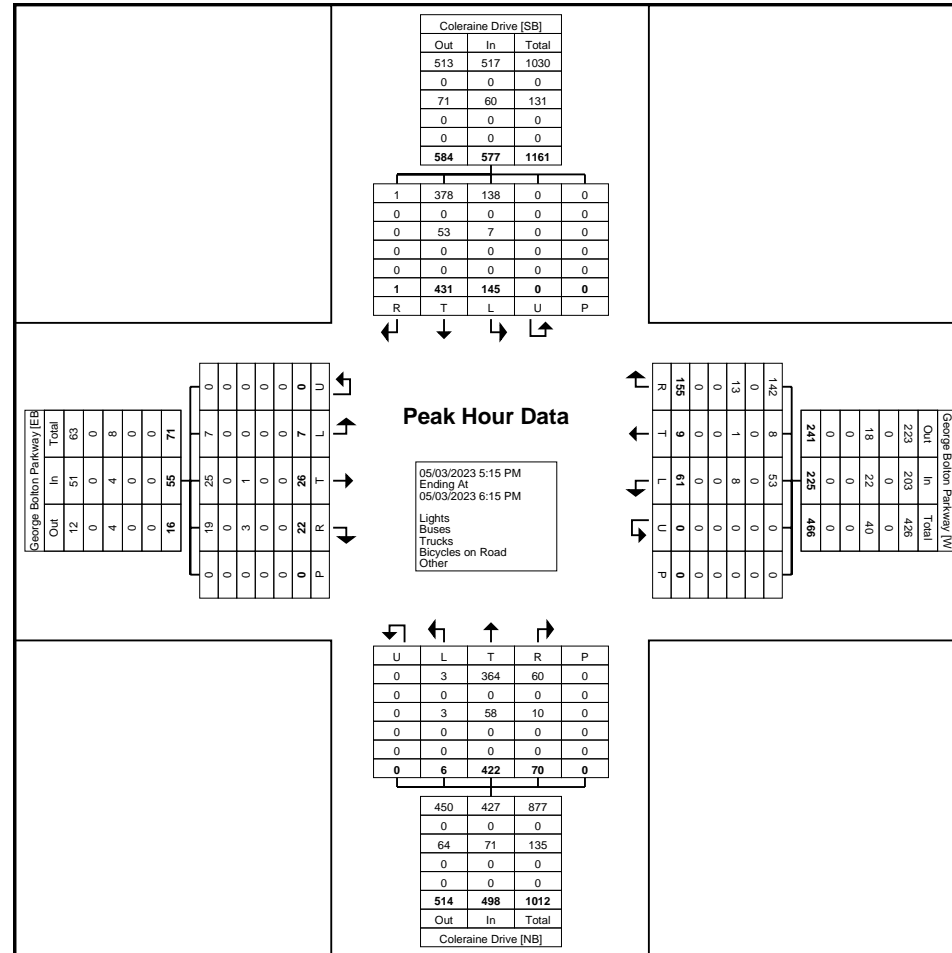

Turning Movement Peak Hour Data Plot (5:15 PM)



LEA Consulting Ltd.
625 Cochrane Drive

Markam, Ontario, Canada L3R 9R9
905-470-0015 x240 idinsmore@lea.ca

Count Name: 23347_Highway 50 & George
Bolton Pkwy-AM
Site Code: 23347
Start Date: 05/03/2023
Page No: 1

Turning Movement Data

Start Time	Highway 50 Southbound						Private Access Westbound						Highway 50 Northbound						George Bolton Parkway Eastbound						Int. Total
	Right	Thru	Left	U-Turn	Peds	App. Total	Right	Thru	Left	U-Turn	Peds	App. Total	Right	Thru	Left	U-Turn	Peds	App. Total	Right	Thru	Left	U-Turn	Peds	App. Total	
7:00 AM	25	264	1	0	0	290	0	0	0	0	0	0	0	156	52	0	0	208	42	0	18	0	0	60	558
7:15 AM	41	254	0	0	0	295	0	0	0	0	0	0	0	170	41	0	0	211	20	0	16	0	0	36	542
7:30 AM	36	266	0	0	0	302	0	0	0	0	0	0	0	159	40	0	0	199	37	0	14	0	1	51	552
7:45 AM	38	291	1	0	0	330	0	0	0	0	0	0	0	234	44	0	0	278	11	0	14	0	0	25	633
Hourly Total	140	1075	2	0	0	1217	0	0	0	0	0	0	0	719	177	0	0	896	110	0	62	0	1	172	2285
8:00 AM	36	291	1	0	0	328	0	0	0	0	0	0	0	214	38	0	0	252	36	0	15	0	0	51	631
8:15 AM	31	282	0	0	0	313	0	0	0	0	0	0	0	196	27	0	0	223	24	0	31	0	0	55	591
8:30 AM	33	261	1	0	0	295	1	0	0	0	0	1	0	200	37	0	0	237	33	0	16	0	0	49	582
8:45 AM	39	278	1	0	0	318	0	0	0	0	0	0	0	217	34	0	0	251	24	0	26	0	0	50	619
Hourly Total	139	1112	3	0	0	1254	1	0	0	0	0	1	0	827	136	0	0	963	117	0	88	0	0	205	2423
9:00 AM	33	240	0	0	0	273	0	0	0	0	0	0	0	191	50	0	0	241	21	0	15	0	0	36	550
9:15 AM	36	219	0	0	1	255	0	0	1	0	1	1	1	170	21	0	0	192	26	0	36	0	0	62	510
9:30 AM	0	1	0	0	0	1	0	0	0	0	0	0	0	1	0	0	0	1	0	0	0	0	0	0	2
Grand Total	348	2647	5	0	1	3000	1	0	1	0	1	2	1	1908	384	0	0	2293	274	0	201	0	1	475	5770
Approach %	11.6	88.2	0.2	0.0	-	-	50.0	0.0	50.0	0.0	-	-	0.0	83.2	16.7	0.0	-	-	57.7	0.0	42.3	0.0	-	-	-
Total %	6.0	45.9	0.1	0.0	-	52.0	0.0	0.0	0.0	0.0	-	0.0	0.0	33.1	6.7	0.0	-	39.7	4.7	0.0	3.5	0.0	-	8.2	-
Lights	332	2425	5	0	-	2762	1	0	1	0	-	2	1	1789	300	0	-	2090	169	0	173	0	-	342	5196
% Lights	95.4	91.6	100.0	-	-	92.1	100.0	-	100.0	-	-	100.0	100.0	93.8	78.1	-	-	91.1	61.7	-	86.1	-	-	72.0	90.1
Buses	0	14	0	0	-	14	0	0	0	0	-	0	0	5	0	0	-	5	2	0	1	0	-	3	22
% Buses	0.0	0.5	0.0	-	-	0.5	0.0	-	0.0	-	-	0.0	0.0	0.3	0.0	-	-	0.2	0.7	-	0.5	-	-	0.6	0.4
Trucks	16	208	0	0	-	224	0	0	0	0	-	0	0	114	84	0	-	198	103	0	27	0	-	130	552
% Trucks	4.6	7.9	0.0	-	-	7.5	0.0	-	0.0	-	-	0.0	0.0	6.0	21.9	-	-	8.6	37.6	-	13.4	-	-	27.4	9.6
Bicycles on Road	0	0	0	0	-	0	0	0	0	0	-	0	0	0	0	0	-	0	0	0	0	0	-	0	0
% Bicycles on Road	0.0	0.0	0.0	-	-	0.0	0.0	-	0.0	-	-	0.0	0.0	0.0	0.0	-	-	0.0	0.0	-	0.0	-	-	0.0	0.0
Bicycles on Crosswalk	-	-	-	-	0	-	-	-	-	-	0	-	-	-	-	-	0	-	-	-	-	-	0	-	-
% Bicycles on Crosswalk	-	-	-	-	0.0	-	-	-	-	-	0.0	-	-	-	-	-	-	-	-	-	-	-	0.0	-	-
Pedestrians	-	-	-	-	1	-	-	-	-	-	1	-	-	-	-	-	0	-	-	-	-	-	1	-	-
% Pedestrians	-	-	-	-	100.0	-	-	-	-	-	100.0	-	-	-	-	-	-	-	-	-	-	-	100.0	-	-



LEA Consulting Ltd.
625 Cochrane Drive

Markam, Ontario, Canada L3R 9R9
905-470-0015 x240 idinsmore@lea.ca

Count Name: 23347_Highway 50 & George
Bolton Pkwy-AM
Site Code: 23347
Start Date: 05/03/2023
Page No: 2

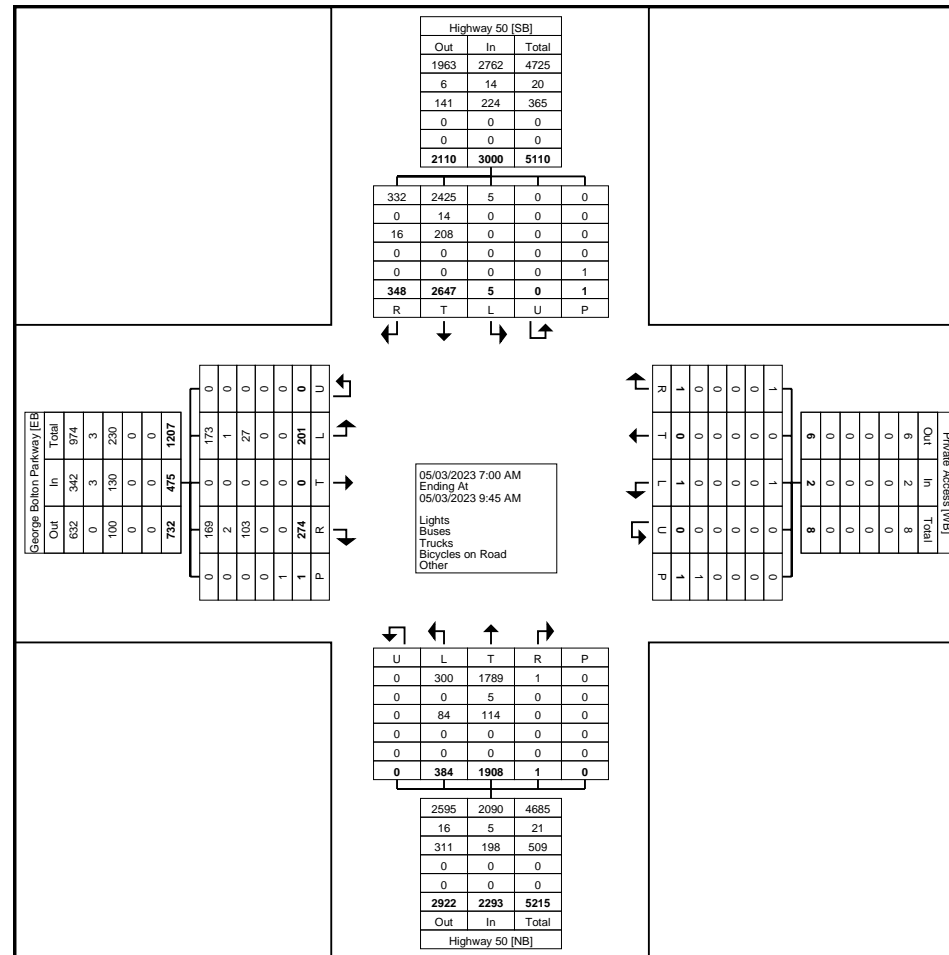

Turning Movement Data Plot



LEA Consulting Ltd.
625 Cochrane Drive

Markam, Ontario, Canada L3R 9R9
905-470-0015 x240 idinsmore@lea.ca

Count Name: 23347_Highway 50 & George
Bolton Pkwy-AM
Site Code: 23347
Start Date: 05/03/2023
Page No: 4

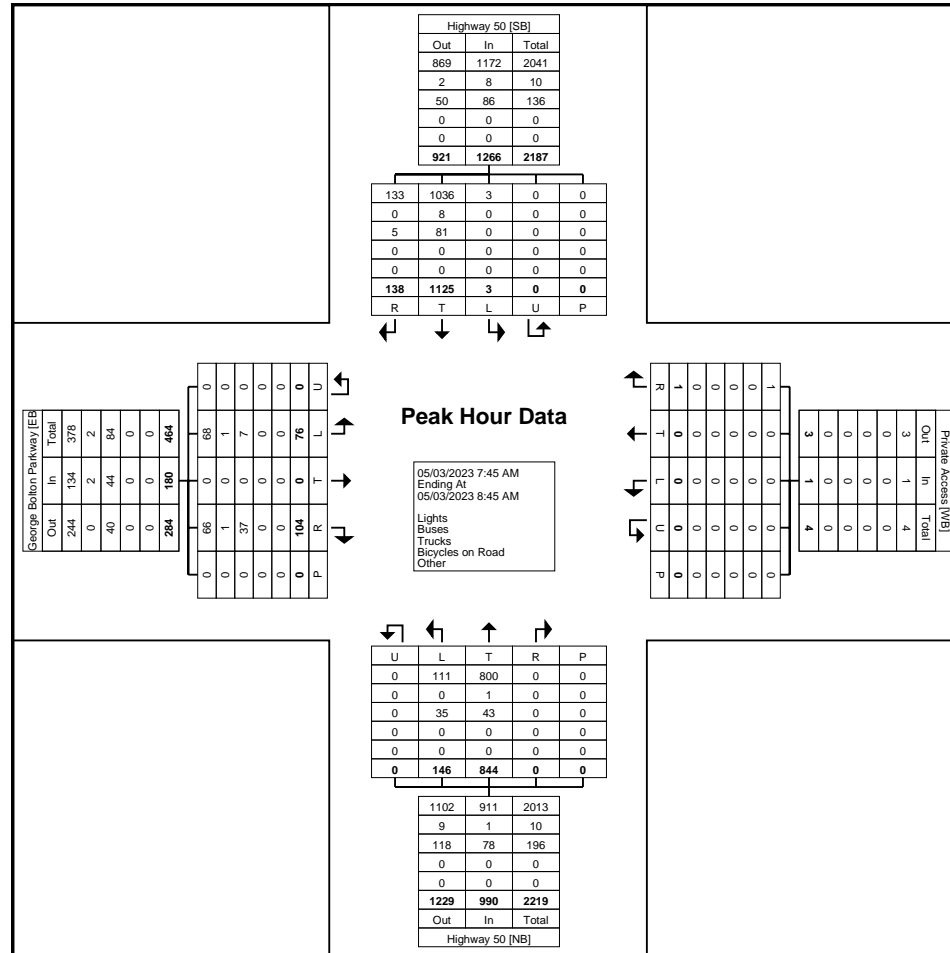

Turning Movement Peak Hour Data Plot (7:45 AM)



LEA Consulting Ltd.
625 Cochrane Drive

Markam, Ontario, Canada L3R 9R9
905-470-0015 x240 idinsmore@lea.ca

Count Name: 23347_Highway 50 & George
Bolton Pkwy-PM
Site Code: 23347
Start Date: 05/03/2023
Page No: 1

Turning Movement Data

Start Time	Highway 50 Southbound						Private Access Westbound						Highway 50 Northbound						George Bolton Parkway Eastbound						Int. Total
	Right	Thru	Left	U-Turn	Peds	App. Total	Right	Thru	Left	U-Turn	Peds	App. Total	Right	Thru	Left	U-Turn	Peds	App. Total	Right	Thru	Left	U-Turn	Peds	App. Total	
4:00 PM	63	213	0	0	0	276	1	0	1	0	0	2	0	296	19	0	0	315	61	0	68	0	1	129	722
4:15 PM	40	235	0	0	0	275	0	0	0	0	0	0	0	251	30	0	0	281	50	0	32	0	1	82	638
4:30 PM	35	240	0	0	0	275	0	0	0	0	0	0	0	273	25	0	0	298	35	0	47	0	1	82	655
4:45 PM	36	225	1	0	0	262	6	0	0	0	0	6	0	317	36	0	0	353	44	0	43	0	0	87	708
Hourly Total	174	913	1	0	0	1088	7	0	1	0	0	8	0	1137	110	0	0	1247	190	0	190	0	3	380	2723
5:00 PM	45	234	0	0	0	279	1	0	0	0	0	1	0	323	24	0	2	347	53	0	59	0	0	112	739
5:15 PM	40	209	0	0	0	249	0	0	0	0	0	0	0	323	31	0	0	354	40	0	60	0	1	100	703
5:30 PM	48	205	0	0	0	253	0	0	0	0	0	0	0	294	38	0	0	332	56	0	47	0	0	103	688
5:45 PM	28	168	0	0	0	196	0	0	0	0	0	0	0	315	32	0	0	347	43	0	51	0	0	94	637
Hourly Total	161	816	0	0	0	977	1	0	0	0	0	1	0	1255	125	0	2	1380	192	0	217	0	1	409	2767
6:00 PM	22	176	0	0	0	198	0	0	0	0	0	0	0	272	39	0	0	311	58	0	36	0	0	94	603
6:15 PM	35	166	0	0	0	201	1	0	0	0	0	1	0	208	41	0	0	249	33	0	25	0	0	58	509
6:30 PM	0	0	0	0	0	0	0	0	0	0	0	0	0	0	0	0	0	0	0	0	0	0	0	0	0
Grand Total	392	2071	1	0	0	2464	9	0	1	0	0	10	0	2872	315	0	2	3187	473	0	468	0	4	941	6602
Approach %	15.9	84.1	0.0	0.0	-	-	90.0	0.0	10.0	0.0	-	-	0.0	90.1	9.9	0.0	-	-	50.3	0.0	49.7	0.0	-	-	-
Total %	5.9	31.4	0.0	0.0	-	37.3	0.1	0.0	0.0	0.0	-	0.2	0.0	43.5	4.8	0.0	-	48.3	7.2	0.0	7.1	0.0	-	14.3	-
Lights	383	1980	1	0	-	2364	9	0	1	0	-	10	0	2724	225	0	-	2949	427	0	463	0	-	890	6213
% Lights	97.7	95.6	100.0	-	-	95.9	100.0	-	100.0	-	-	100.0	-	94.8	71.4	-	-	92.5	90.3	-	98.9	-	-	94.6	94.1
Buses	0	3	0	0	-	3	0	0	0	0	-	0	0	5	2	0	-	7	0	0	1	0	-	1	11
% Buses	0.0	0.1	0.0	-	-	0.1	0.0	-	0.0	-	-	0.0	-	0.2	0.6	-	-	0.2	0.0	-	0.2	-	-	0.1	0.2
Trucks	9	88	0	0	-	97	0	0	0	0	-	0	0	143	88	0	-	231	46	0	4	0	-	50	378
% Trucks	2.3	4.2	0.0	-	-	3.9	0.0	-	0.0	-	-	0.0	-	5.0	27.9	-	-	7.2	9.7	-	0.9	-	-	5.3	5.7
Bicycles on Road	0	0	0	0	-	0	0	0	0	0	-	0	0	0	0	0	-	0	0	0	0	0	-	0	0
% Bicycles on Road	0.0	0.0	0.0	-	-	0.0	0.0	-	0.0	-	-	0.0	-	0.0	0.0	-	-	0.0	0.0	-	0.0	-	-	0.0	0.0
Bicycles on Crosswalk	-	-	-	-	0	-	-	-	-	-	0	-	-	-	-	-	0	-	-	-	-	-	1	-	-
% Bicycles on Crosswalk	-	-	-	-	-	-	-	-	-	-	-	-	-	-	-	-	0.0	-	-	-	-	-	25.0	-	-
Pedestrians	-	-	-	-	0	-	-	-	-	-	0	-	-	-	-	-	2	-	-	-	-	-	3	-	-
% Pedestrians	-	-	-	-	-	-	-	-	-	-	-	-	-	-	-	-	100.0	-	-	-	-	-	75.0	-	-



LEA Consulting Ltd.
625 Cochrane Drive

Markam, Ontario, Canada L3R 9R9
905-470-0015 x240 idinsmore@lea.ca

Count Name: 23347_Highway 50 & George
Bolton Pkwy-PM
Site Code: 23347
Start Date: 05/03/2023
Page No: 2

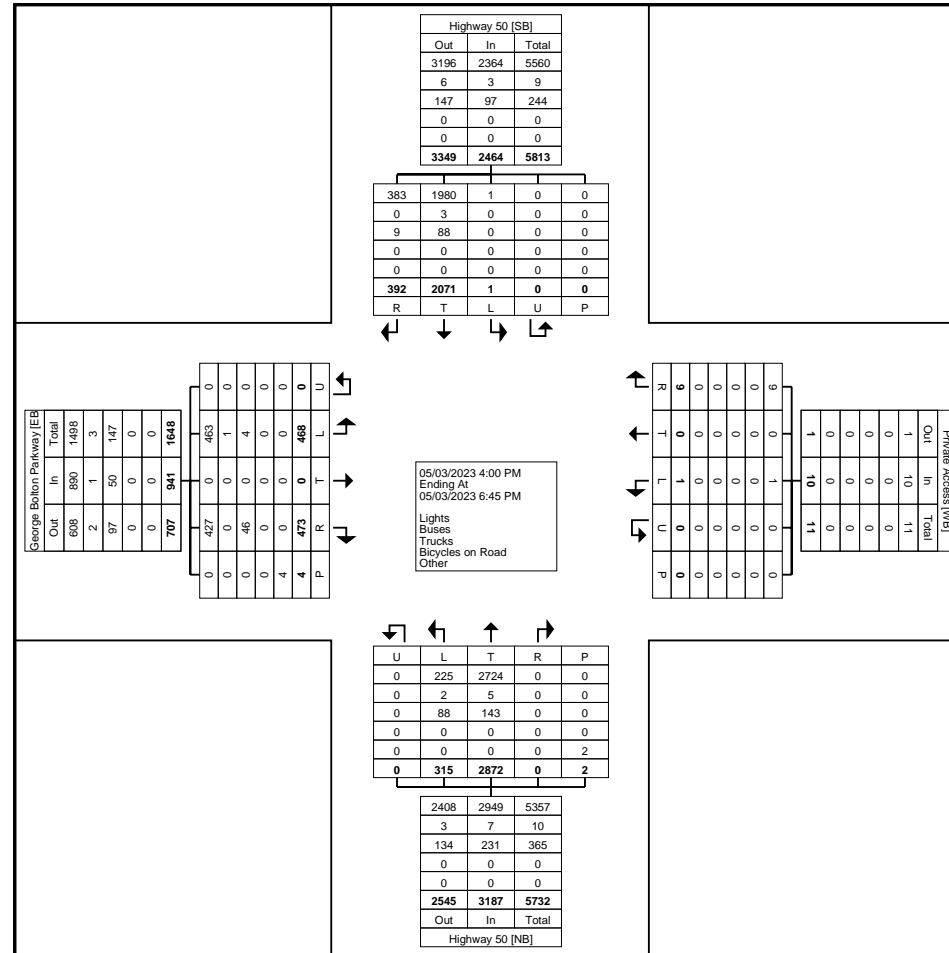

Turning Movement Data Plot



LEA Consulting Ltd.
625 Cochrane Drive

Markam, Ontario, Canada L3R 9R9
905-470-0015 x240 idinsmore@lea.ca

Count Name: 23347_Highway 50 & George
Bolton Pkwy-PM
Site Code: 23347
Start Date: 05/03/2023
Page No: 3

Turning Movement Peak Hour Data (4:45 PM)

Start Time	Highway 50 Southbound						Private Access Westbound						Highway 50 Northbound						George Bolton Parkway Eastbound						Int. Total	
	Right	Thru	Left	U-Turn	Peds	App. Total	Right	Thru	Left	U-Turn	Peds	App. Total	Right	Thru	Left	U-Turn	Peds	App. Total	Right	Thru	Left	U-Turn	Peds	App. Total		
4:45 PM	36	225	1	0	0	262	6	0	0	0	0	6	0	317	36	0	0	0	353	44	0	43	0	0	87	708
5:00 PM	45	234	0	0	0	279	1	0	0	0	0	1	0	323	24	0	2	347	53	0	59	0	0	112	739	
5:15 PM	40	209	0	0	0	249	0	0	0	0	0	0	0	323	31	0	0	354	40	0	60	0	1	100	703	
5:30 PM	48	205	0	0	0	253	0	0	0	0	0	0	0	294	38	0	0	332	56	0	47	0	0	103	688	
Total	169	873	1	0	0	1043	7	0	0	0	0	7	0	1257	129	0	2	1386	193	0	209	0	1	402	2838	
Approach %	16.2	83.7	0.1	0.0	-	-	100.0	0.0	0.0	0.0	0.0	-	0.0	90.7	9.3	0.0	-	-	48.0	0.0	52.0	0.0	-	-	-	
Total %	6.0	30.8	0.0	0.0	-	36.8	0.2	0.0	0.0	0.0	-	0.2	0.0	44.3	4.5	0.0	-	48.8	6.8	0.0	7.4	0.0	-	14.2	-	
PHF	0.880	0.933	0.250	0.000	-	0.935	0.292	0.000	0.000	0.000	-	0.292	0.000	0.973	0.849	0.000	-	0.979	0.862	0.000	0.871	0.000	-	0.897	0.960	
Lights	166	844	1	0	-	1011	7	0	0	0	-	7	0	1196	102	0	-	1298	170	0	208	0	-	378	2694	
% Lights	98.2	96.7	100.0	-	-	96.9	100.0	-	-	-	-	100.0	-	95.1	79.1	-	-	93.7	88.1	-	99.5	-	-	94.0	94.9	
Buses	0	1	0	0	-	1	0	0	0	0	-	0	0	2	1	0	-	3	0	0	0	0	-	0	4	
% Buses	0.0	0.1	0.0	-	-	0.1	0.0	-	-	-	-	0.0	-	0.2	0.8	-	-	0.2	0.0	-	0.0	-	-	0.0	0.1	
Trucks	3	28	0	0	-	31	0	0	0	0	-	0	0	59	26	0	-	85	23	0	1	0	-	24	140	
% Trucks	1.8	3.2	0.0	-	-	3.0	0.0	-	-	-	-	0.0	-	4.7	20.2	-	-	6.1	11.9	-	0.5	-	-	6.0	4.9	
Bicycles on Road	0	0	0	0	-	0	0	0	0	0	-	0	0	0	0	0	-	0	0	0	0	0	-	0	0	
% Bicycles on Road	0.0	0.0	0.0	-	-	0.0	0.0	-	-	-	-	0.0	-	0.0	0.0	-	-	0.0	0.0	-	0.0	-	-	0.0	0.0	
Bicycles on Crosswalk	-	-	-	-	0	-	-	-	-	0	-	-	-	-	-	-	0	-	-	-	-	-	0	-	-	
% Bicycles on Crosswalk	-	-	-	-	-	-	-	-	-	-	-	-	-	-	-	-	0.0	-	-	-	-	0.0	-	-	-	
Pedestrians	-	-	-	-	0	-	-	-	-	0	-	-	-	-	-	-	2	-	-	-	-	-	1	-	-	
% Pedestrians	-	-	-	-	-	-	-	-	-	-	-	-	-	-	-	-	100.0	-	-	-	-	-	100.0	-	-	



LEA Consulting Ltd.
625 Cochrane Drive

Markam, Ontario, Canada L3R 9R9
905-470-0015 x240 idinsmore@lea.ca

Count Name: 23347_Highway 50 & George
Bolton Pkwy-PM
Site Code: 23347
Start Date: 05/03/2023
Page No: 4

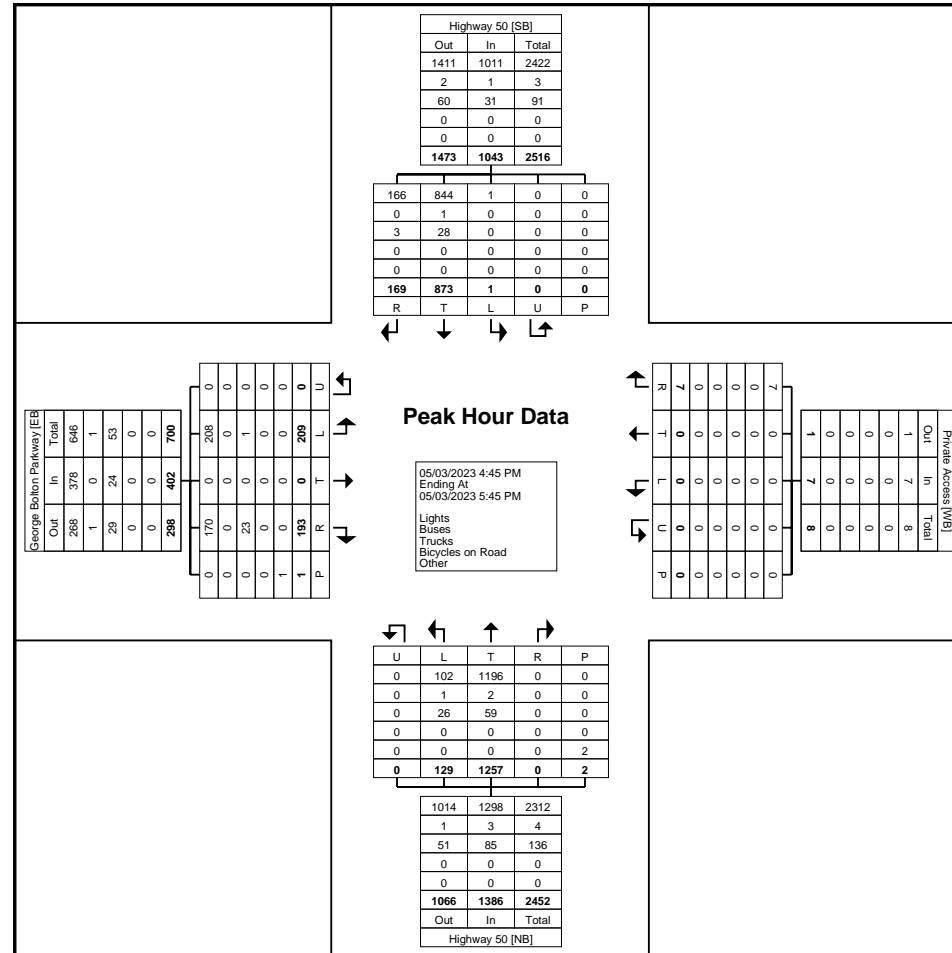

Turning Movement Peak Hour Data Plot (4:45 PM)

MG8 ENG

Morning Peak Diagram

Specified Period

From: 7:00:00

To: 9:00:00

One Hour Peak

From: 7:00:00

To: 8:00:00

Municipality: Region of Peel
Site #: 0001401354
Intersection: Mayfield Road & Coleraine Drive
TFR File #: 1
Count date: 7-May-2013

Weather conditions:
Person(s) who counted:
 PREDO

** Signalized Intersection **

Major Road: Mayfield Road runs W/E

North Leg Total: 850
 North Entering: 488
 North Peds: 0
 Peds Cross:

Cyclists	0	1	0	1
Trucks	26	8	7	41
Cars	108	330	8	446
Totals	134	339	15	

Cyclists 1
 Trucks 30
 Cars 331
 Totals 362

East Leg Total: 808
 East Entering: 467
 East Peds: 0
 Peds Cross:

Cyclists	Trucks	Cars	Totals
3	71	483	557

Mayfield Road

Cyclists	Trucks	Cars	Totals
1	17	216	234
0	38	279	317
1	1	48	50
2	56	543	

Coleraine Drive

Cars	Trucks	Cyclists	Totals
12	8	0	20
357	43	3	403
44	0	0	44
413	51	3	

W E
 S

Mayfield Road

Coleraine Drive

Peds Cross:
 West Peds: 0
 West Entering: 601
 West Leg Total: 1158

Cars	422	Cars	18	103	8	129
Trucks	9	Trucks	2	5	1	8
Cyclists	2	Cyclists	0	0	0	0
Totals	433	Totals	20	108	9	

Peds Cross:
 South Peds: 0
 South Entering: 137
 South Leg Total: 570

Comments

MG8 ENG

Afternoon Peak Diagram

Specified Period

From: 15:00:00
To: 18:00:00

One Hour Peak

From: 17:00:00
To: 18:00:00

Municipality: Region of Peel
Site #: 0001401354
Intersection: Mayfield Road & Coleraine Drive
TFR File #: 1
Count date: 7-May-2013

Weather conditions:
Person(s) who counted:
PREDO

**** Signalized Intersection ****

Major Road: Mayfield Road runs W/E

North Leg Total: 865
North Entering: 401
North Peds: 0
Peds Cross: \times

Cyclists	1	0	0	1
Trucks	27	2	9	38
Cars	191	155	16	362
Totals	219	157	25	



Cyclists 1
Trucks 45
Cars 418
Totals 464

East Leg Total: 1013
East Entering: 509
East Peds: 0
Peds Cross: \times

Cyclists	Trucks	Cars	Totals
3	75	651	729



Coleraine Drive

Cars	Trucks	Cyclists	Totals
26	12	0	38
408	48	2	458
12	1	0	13
446	61	2	



Mayfield Road

Cyclists	Trucks	Cars	Totals
1	32	135	168
2	48	408	458
0	0	29	29
3	80	572	

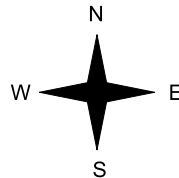

Mayfield Road



Cars	Trucks	Cyclists	Totals
445	57	2	504

Peds Cross: \times
West Peds: 0
West Entering: 655
West Leg Total: 1384

Cars	196	Cars	52	257	21	330
Trucks	3	Trucks	0	1	0	1
Cyclists	0	Cyclists	0	0	0	0
Totals	199	Totals	52	258	21	

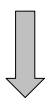

Peds Cross: \times
South Peds: 0
South Entering: 331
South Leg Total: 530

Comments

REGIONAL MUNICIPALITY OF PEEL

Traffic Signal Timing Parameters

Database Date	August 31, 2020		Prepared Date	July 4, 2023
Database Rev	-		Completed By	TF
Timing Card / Field rev	1		Checked By	MH

Location **Coleraine Drive at George Bolton Parkway**

Phase #	Street Name - Direction	Vehicle Minimum (s)	Pedestrian Minimum (s)		Amber (s)	All Red (s)	TIME PERIOD (s)		
			WALK	FDWALK			AM SPLITS	OFF SPLITS	PM SPLITS
1	Not In Use	-	-	-	-	-	-	-	-
2	Coleraine Drive - SB	12.0	8.0	19.0	4.2	2.5	55.0	65.7	55.0
3	Not In Use	-	-	-	-	-	-	-	-
4	George Bolton Parkway - WB	12.0	8.0	17.0	4.0	3.5	45.0	19.5 (min), 47.5 (max)	45.0
5	Not In Use	-	-	-	-	-	-	-	-
6	Coleraine Drive - NB	12.0	8.0	19.0	4.2	2.5	55.0	65.7	55.0
7	Not In Use	-	-	-	-	-	-	-	-
8	George Bolton Parkway - EB	12.0	8.0	17.0	4.0	3.5	45.0	19.5 (min), 47.5 (max)	45.0

System Control Yes		TIME (M-F)	PEAK	CYCLE LENGTH (s)	OFFSET (s)
		06:00 - 09:00	AM	100	0
Semi-Actuated Mode Yes		09:00 - 15:00 19:00 - 00:00	OFF	0	0
		15:00 - 19:00	PM	100	0

REGIONAL MUNICIPALITY OF PEEL

Traffic Signal Timing Parameters

Database Date	June 27, 2023		Prepared Date	June 30, 2023
Database Rev	iNET		Completed By	TF
Timing Card / Field rev	8		Checked By	MH

Location **Coleraine Drive at Healey Road**

Phase #	Street Name - Direction	Vehicle Minimum (s)	Pedestrian Minimum (s)		Amber (s)	All Red (s)	TIME PERIOD (s)		
			WALK	FDWALK			AM SPLITS	OFF SPLITS	PM SPLITS
			1	Not In Use			-	-	-
2	Coleraine Drive - SB	8.0	8.0	25.0	4.2	2.4	37.0	37.0	37.0
3	Healey Road - EB Prot. Perm. LT	5.0	0.0	0.0	3.0	0.0	10.0	10.0	10.0
4	Healey Road - WB	8.0	8.0	25.0	4.0	2.8	33.0	33.0	33.0
5	Not In Use	-	-	-	-	-	-	-	-
6	Coleraine Drive - NB	8.0	8.0	25.0	4.2	2.4	37.0	37.0	37.0
7	Not In Use	-	-	-	-	-	-	-	-
8	Healey Road - EB	8.0	8.0	25.0	4.0	2.8	43.0	43.0	43.0

System Control Yes		TIME (M-F)	PEAK	CYCLE LENGTH (s)	OFFSET (s)
		06:00 - 09:00	AM	80	6
Semi-Actuated Mode		09:00 - 15:00	OFF	80	3
Yes		15:00 - 19:00	PM	80	12

REGIONAL MUNICIPALITY OF PEEL

Traffic Signal Timing Parameters

Database Date	June 27, 2023		Prepared Date	June 30, 2023
Database Rev	iNET		Completed By	TF
Timing Card / Field rev	6		Checked By	MH

Location Highway 50 at George Bolton Parkway

Phase #	Street Name - Direction	Vehicle Minimum (s)	Pedestrian Minimum (s)		Amber (s)	All Red (s)	TIME PERIOD (s)		
			WALK	FDWALK			AM SPLITS	OFF SPLITS	PM SPLITS
			1	Highway 50 - NB Prot. Perm. LT			5.0	0.0	0.0
2	Highway 50 - SB	12.0	8.0	13.0	4.0	2.3	75.0	65.0	75.0
3	Not In Use	-	-	-	-	-	-	-	-
4	George Bolton Parkway - WB	8.0	8.0	18.0	4.0	2.6	35.0	35.0	35.0
5	Not In Use	-	-	-	-	-	-	-	-
6	Highway 50 - NB	12.0	8.0	13.0	4.0	2.3	85.0	75.0	85.0
7	Not In Use	-	-	-	-	-	-	-	-
8	George Bolton Parkway - EB	8.0	8.0	18.0	4.0	2.6	35.0	35.0	35.0

<p>System Control Yes</p> <p>Semi-Actuated Mode Yes</p>	<table border="1" style="width: 100%; border-collapse: collapse;"> <thead> <tr style="background-color: #e1f5fe;"> <th>TIME (M-F)</th> <th>PEAK</th> <th>CYCLE LENGTH (s)</th> <th>OFFSET (s)</th> </tr> </thead> <tbody> <tr> <td>06:00 - 09:00</td> <td>AM</td> <td>120</td> <td>113</td> </tr> <tr> <td>09:00 - 15:00</td> <td>OFF</td> <td>110</td> <td>73</td> </tr> <tr style="background-color: #e1f5fe;"> <td>15:00 - 19:00</td> <td>PM</td> <td>120</td> <td>116</td> </tr> </tbody> </table>	TIME (M-F)	PEAK	CYCLE LENGTH (s)	OFFSET (s)	06:00 - 09:00	AM	120	113	09:00 - 15:00	OFF	110	73	15:00 - 19:00	PM	120	116
TIME (M-F)	PEAK	CYCLE LENGTH (s)	OFFSET (s)														
06:00 - 09:00	AM	120	113														
09:00 - 15:00	OFF	110	73														
15:00 - 19:00	PM	120	116														

REGIONAL MUNICIPALITY OF PEEL

Traffic Signal Timing Parameters

Database Date	June 27, 2023		Prepared Date	June 30, 2023
Database Rev	Maxview		Completed By	TF
Timing Card / Field rev	-		Checked By	MH

Location	Mayfield Road at Clarkway Drive / Humber Station Road
----------	---

Phase #	Street Name - Direction	Vehicle Minimum (s)	Pedestrian Minimum (s)		Amber (s)	All Red (s)	TIME PERIOD (s)		
			WALK	FDWALK			AM SPLITS	OFF SPLITS	PM SPLITS
			1	Not In Use			-	-	-
2	Mayfield Road - EB	12.0	12.0	8.0	4.6	2.7	70.0	50.0	55.0
3	Humber Station Road - SB	8.0	12.0	7.0	4.2	2.8	30.0	20.0	20.0
4	Clarkway Drive - NB	8.0	12.0	7.0	4.2	2.8	20.0	30.0	45.0
5	Not In Use	-	-	-	-	-	-	-	-
6	Mayfield Road - WB	12.0	12.0	8.0	4.6	2.7	70.0	50.0	55.0
7	Not In Use	-	-	-	-	-	-	-	-
8	Computer Phase	8.0	12.0	7.0	4.2	2.8	50.0	50.0	65.0

System Control Yes		TIME (M-F)	PEAK	CYCLE LENGTH (s)	OFFSET (s)
		06:30 - 09:00	AM	120	31
Semi-Actuated Mode		09:00 - 15:00	OFF	100	45
No		15:00 - 19:30	PM	120	43

REGIONAL MUNICIPALITY OF PEEL

Traffic Signal Timing Parameters

Database Date	February 3, 2023		Prepared Date	June 30, 2023
Database Rev	Maxview		Completed By	TF
Timing Card / Field rev	-		Checked By	MH

Location: Mayfield Road at Coleraine Drive									
Phase #	Street Name - Direction	Vehicle Minimum (s)	Pedestrian Minimum (s)		Amber (s)	All Red (s)	TIME PERIOD (s)		
			WALK	FDWALK			AM SPLITS	OFF SPLITS	PM SPLITS
1	Not In Use	-	-	-	-	-	-	-	-
2	Mayfield Road - EB	12.0	12.0	18.0	4.6	2.4	80.0	62.0	80.0
3	Coleraine Drive SB Prot. Perm. LT	5.0	0.0	0.0	3.0	0.0	18.0	10.0	14.0
4	Coleraine Drive - NB	12.0	12.0	18.0	4.2	2.8	32.0	38.0	36.0
5	Mayfield Road - EB Prot. Perm. LT	5.0	0.0	0.0	3.0	0.0	15.0	9.0	12.0
6	Mayfield Road - WB	12.0	12.0	18.0	4.6	2.4	65.0	53.0	68.0
7	Not In Use	-	-	-	-	-	-	-	-
8	Coleriane Drive - SB	12.0	12.0	18.0	4.2	2.8	50.0	48.0	50.0

System Control Yes		TIME (M-F)	PEAK	CYCLE LENGTH (s)	OFFSET (s)	
		06:30 - 09:00	AM	130	92	
	Semi-Actuated Mode		09:00 - 15:00 19:30 - 22:00	OFF	110	48
		Yes	15:00 - 19:30	PM	130	116



APPENDIX C

Background Developments



Background Development Excerpts

Table 5-1 Trip Generation Summary

Land Use	Size	Weekday A.M. Peak Hour			Weekday P.M. Peak Hour		
		In	Out	Total	In	Out	Total
Gasoline Station with Convenience Market and Car Wash	8 Positions	43	42	85	53	54	107
Auto Body Shop / Shopping Center	278.7 m ² / 3,000 s.f.	12	7	19	30	32	62
Office	460.7 m ² / 4960 s.f.	15	2	17	14	70	84
Pass-by Trips		31	31	62	40	40	80
Primary New Trips		39	20	59	57	116	173

In order to analyze the future total conditions, the estimated new peak hour vehicular trips summarized in Table 5-1 were assigned to the site driveways and study intersections. The directional route distribution of site generated traffic was based on the access configuration.

Based on the abovementioned trip distribution the estimated new trips associated with the proposed development summarized in Table 5-1 were assigned at the site driveways and study intersections accordingly. The total new assigned peak hour site generated traffic volumes with pass-by reduction are shown in Figure 5-1.

Figure 5-1 Total Peak Hour Proposed Site Development Related Trips

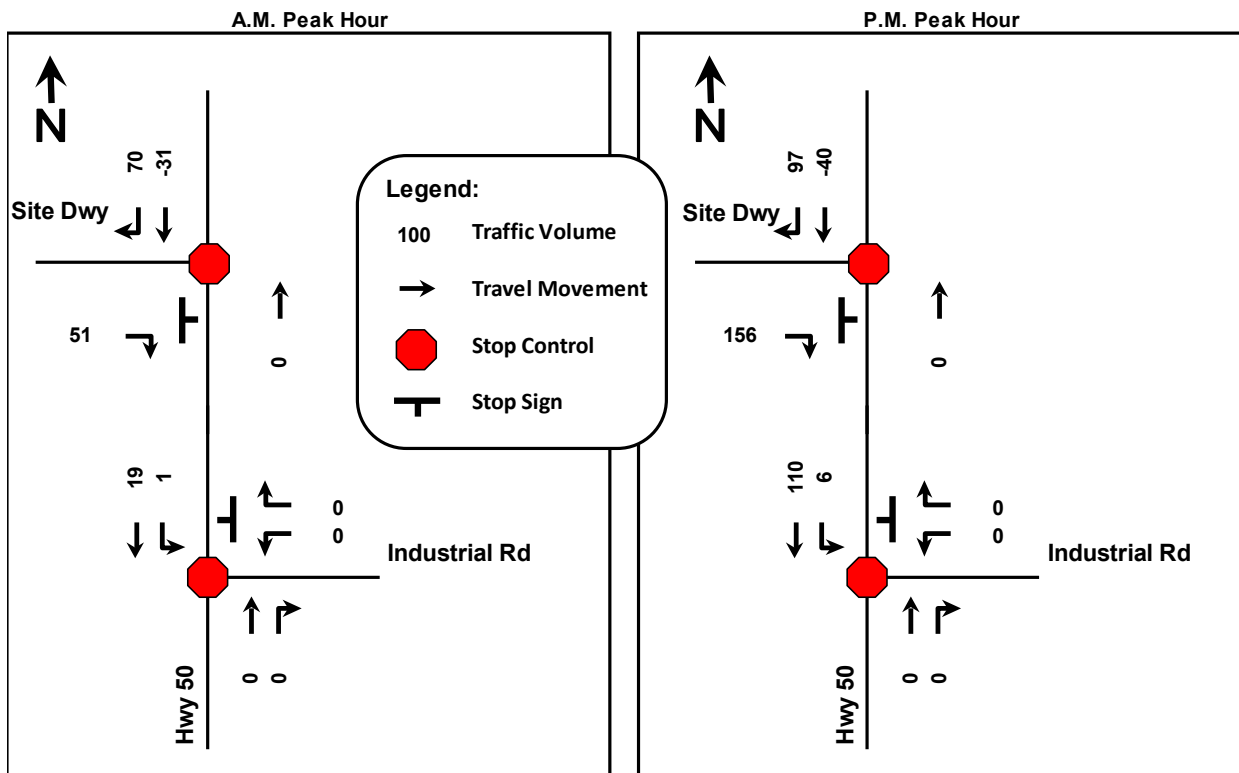

Date Plotted: January 10, 2022 File name: P:\80\76\01\Graphics\CAD\Fig21+01-Phase1TST.dwg

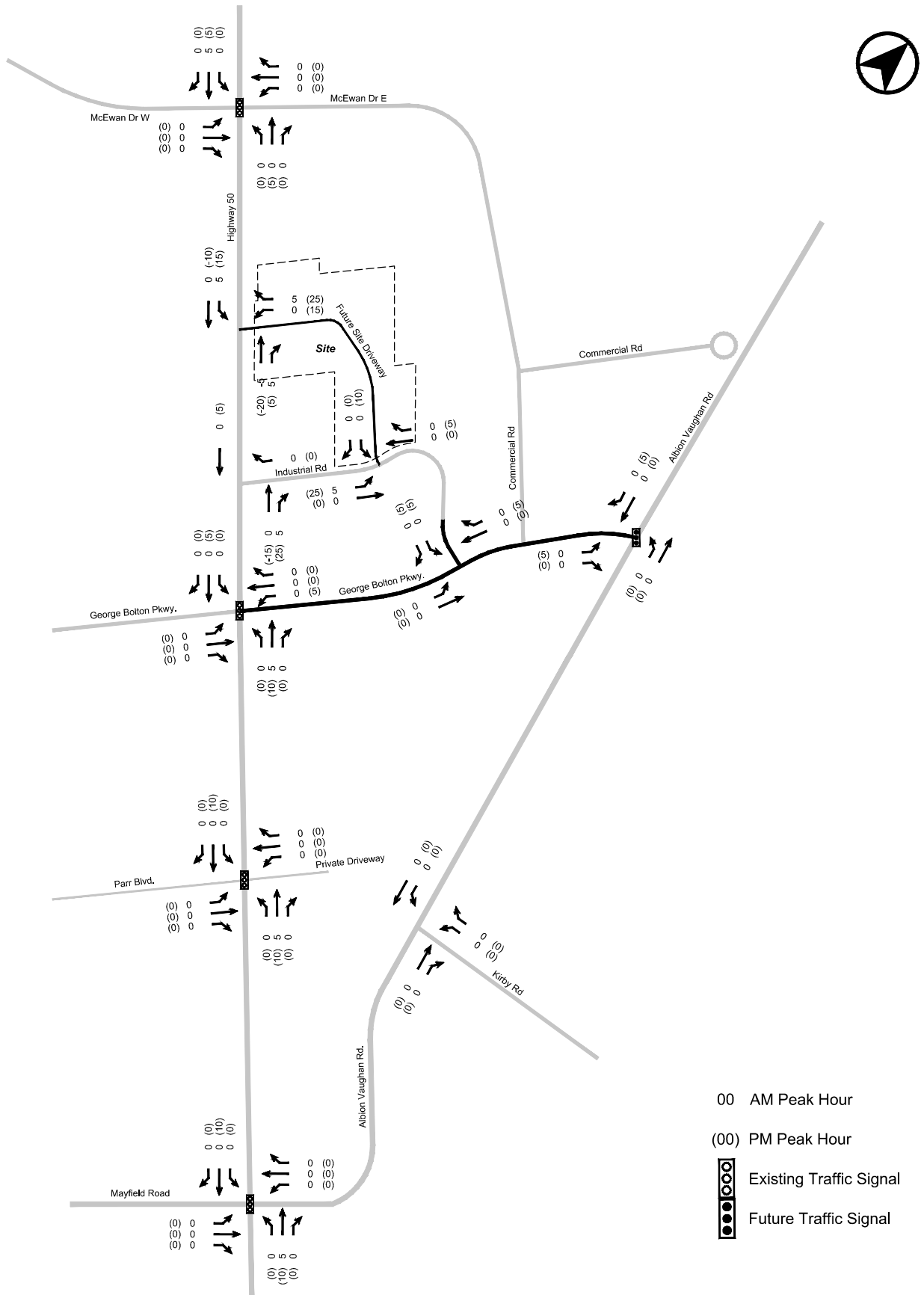

FIGURE 21 PHASE 1 TOTAL SITE TRAFFIC VOLUMES

Date Plotted: January 10, 2022 File name: P:\80\76\01\Graphics\CAD\Fig24-01-FullTST.dwg

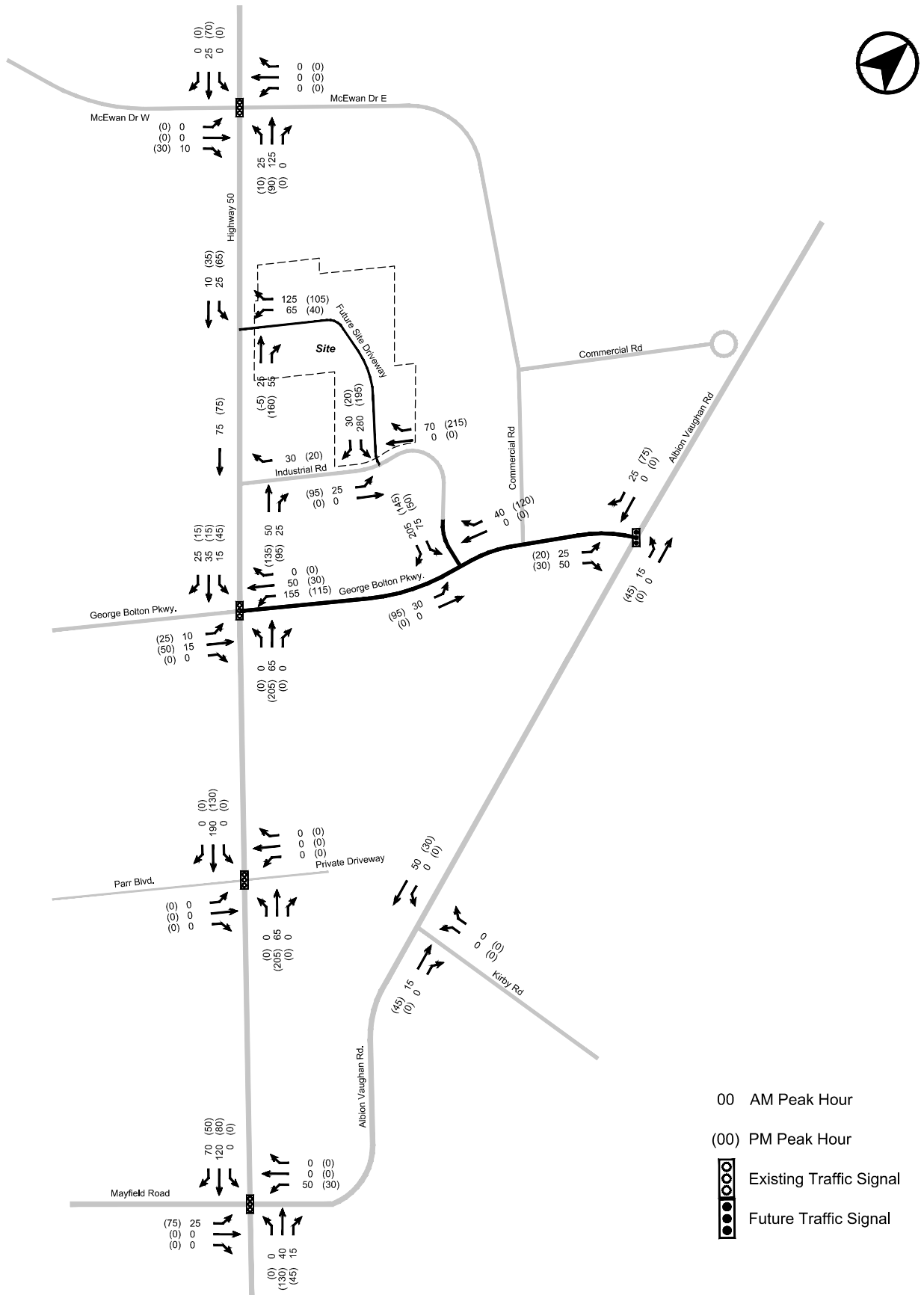
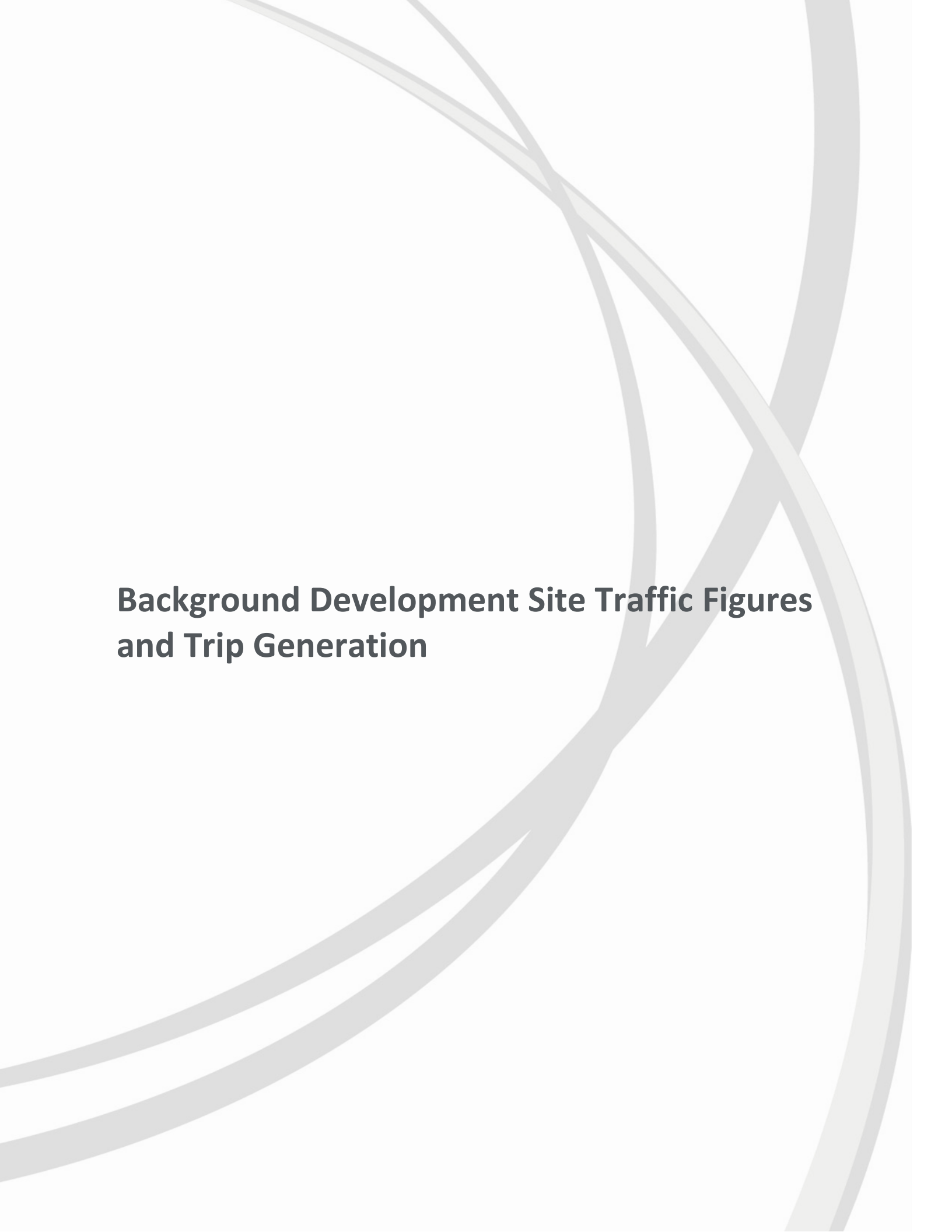

FIGURE 24 FULL BUILD-OUT TOTAL SITE TRAFFIC VOLUMES



**Background Development Site Traffic Figures
and Trip Generation**



12544 Highway 50 Background Development Trips (2028 & 2033)

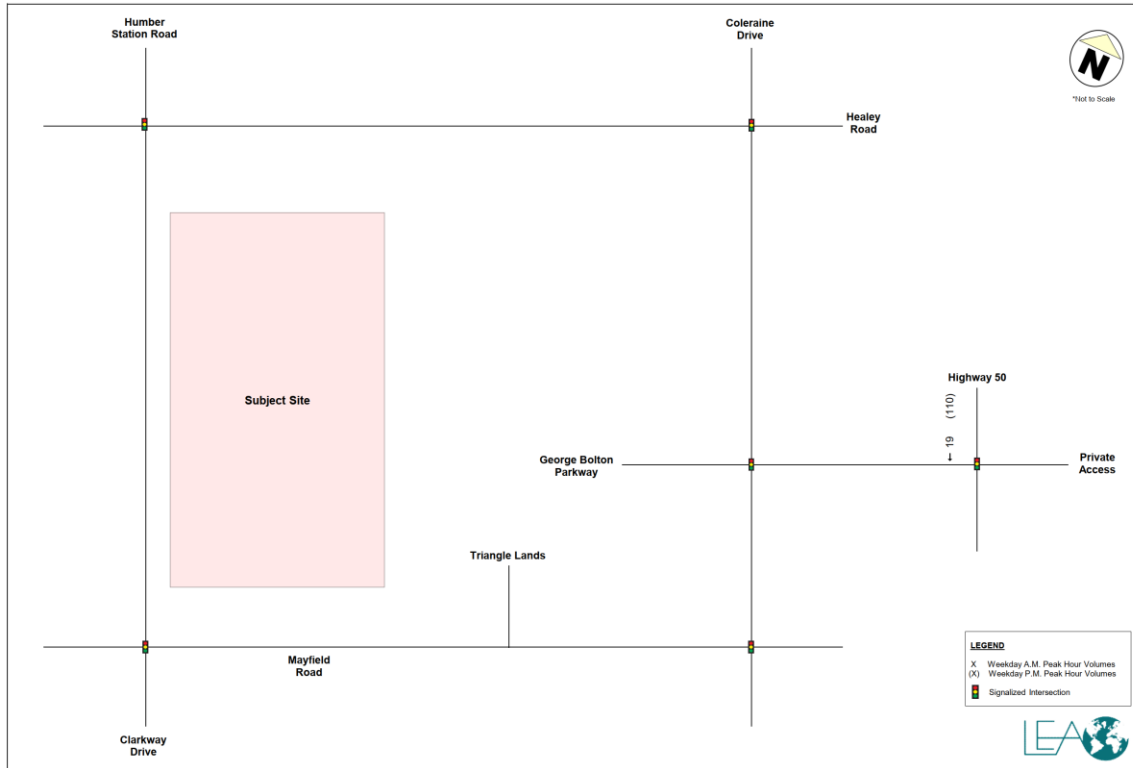

12544 Highway 50 Background Development Trips (2043)

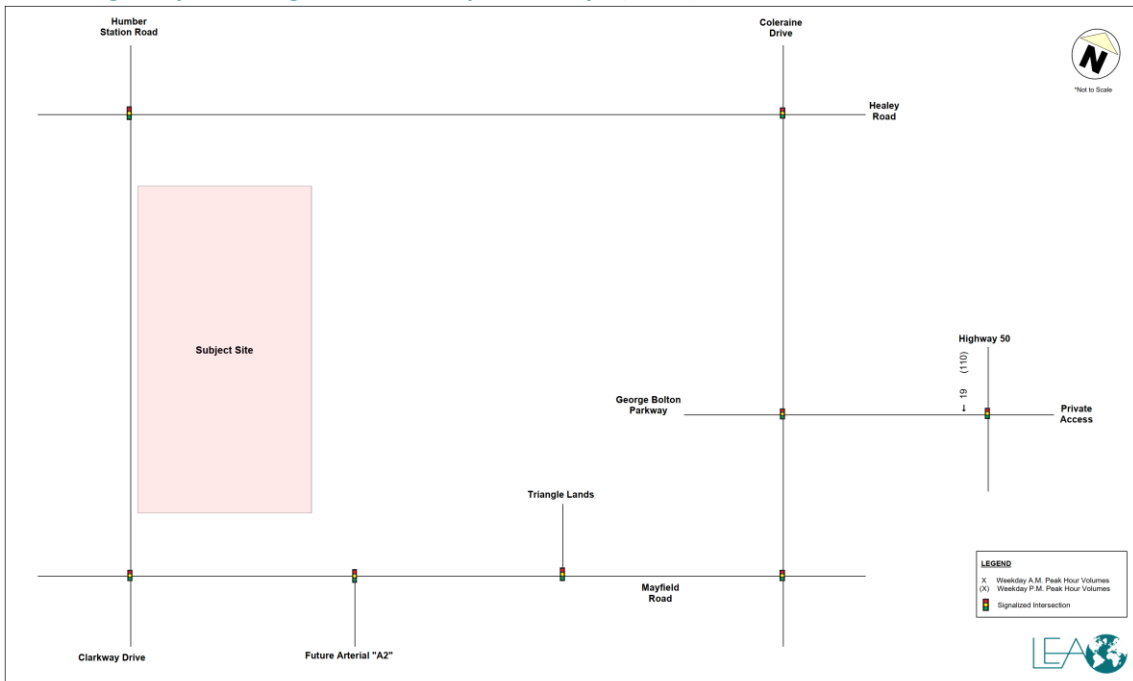



Triangle Lands Vehicle and Truck Trip Generation

Land Use	Description	Weekday AM Peak Hour			Weekday PM Peak Hour		
		In	Out	Total	In	Out	Total
Triangle Lands (Vehicle)							
ITE LUC 140 – Manufacturing 1066 Employees	Auto Trip Rate (/employee)	0.23	0.09	0.32	0.11	0.20	0.31
	Total ITE Auto Trips	249	92	341	122	208	330
	External Auto Trips (100%)	249	92	341	122	208	330
Triangle Lands (Truck)							
ITE LUC 140 – Manufacturing 1066 Employees	Truck Trip Rate (/employee)	0.02	0.01	0.03	0.02	0.03	0.05
	Total ITE Auto Trips	19	13	32	20	34	54
	External Truck Trips (100%)	19	13	32	20	34	54

Triangle Lands Background Development Vehicle Trips (2028 & 2033)

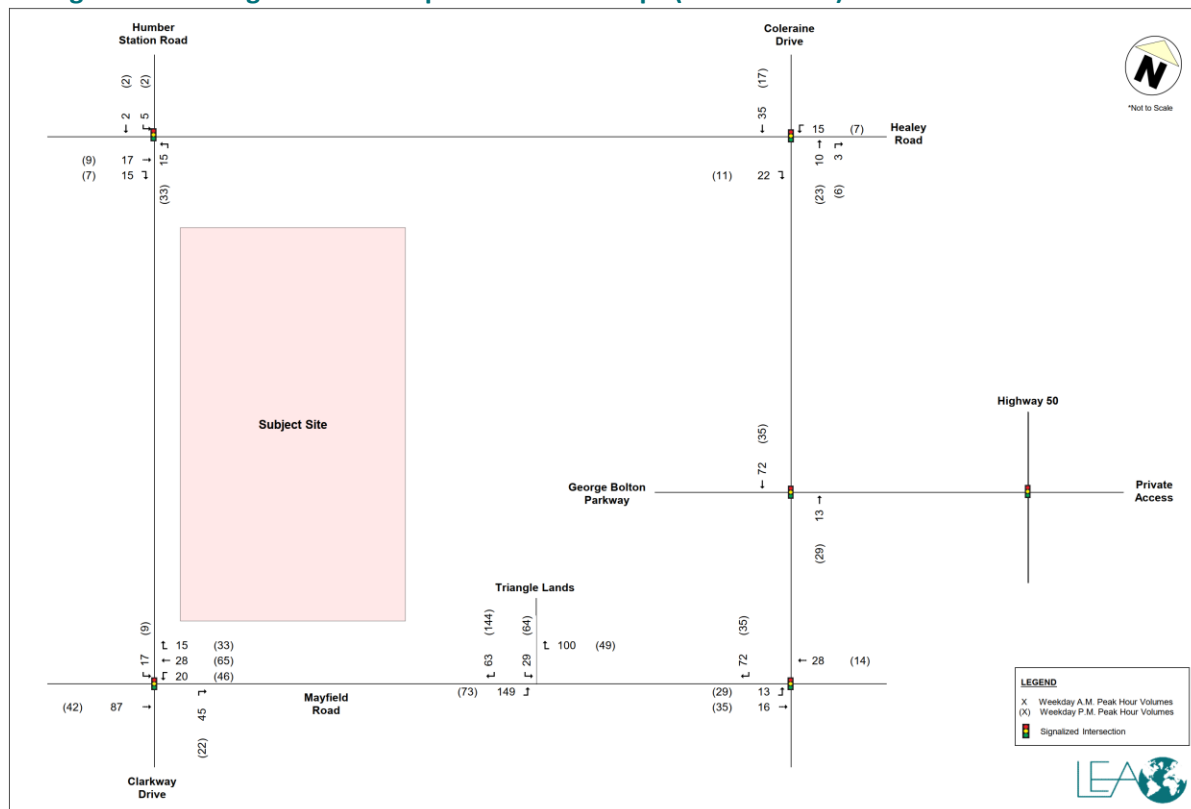



Triangle Lands Background Development Truck Trips (2028 & 2033)

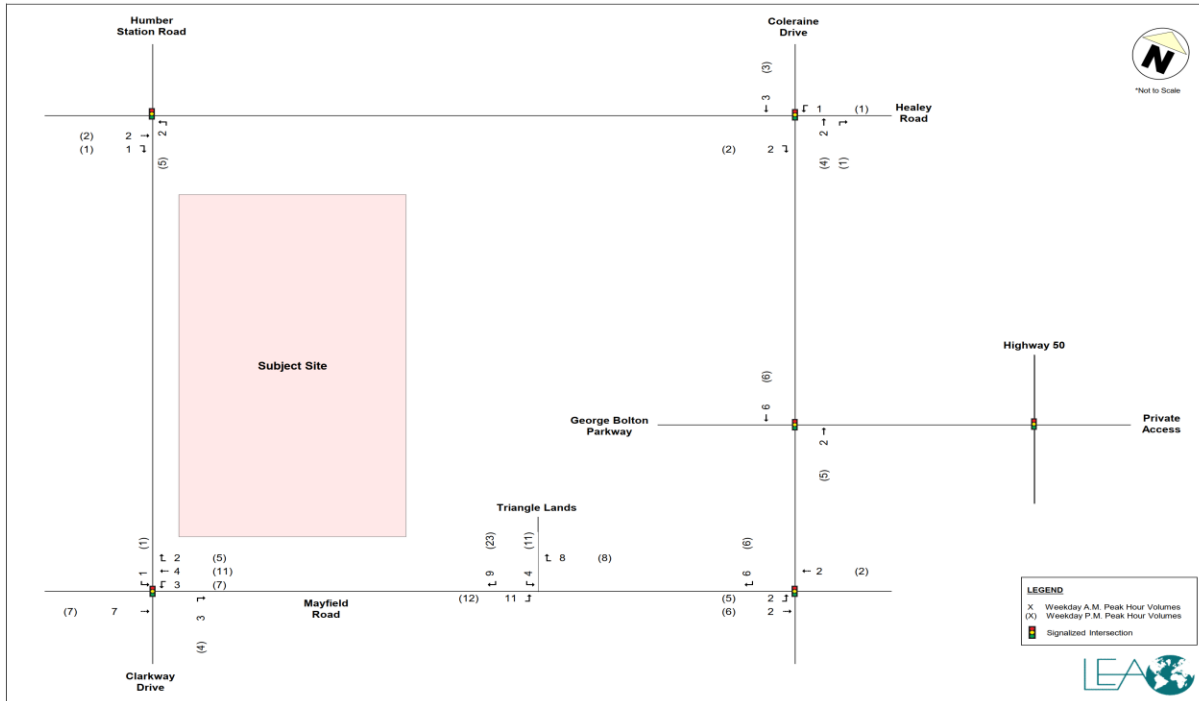

Triangle Lands Background Development Vehicle Trips (2043)

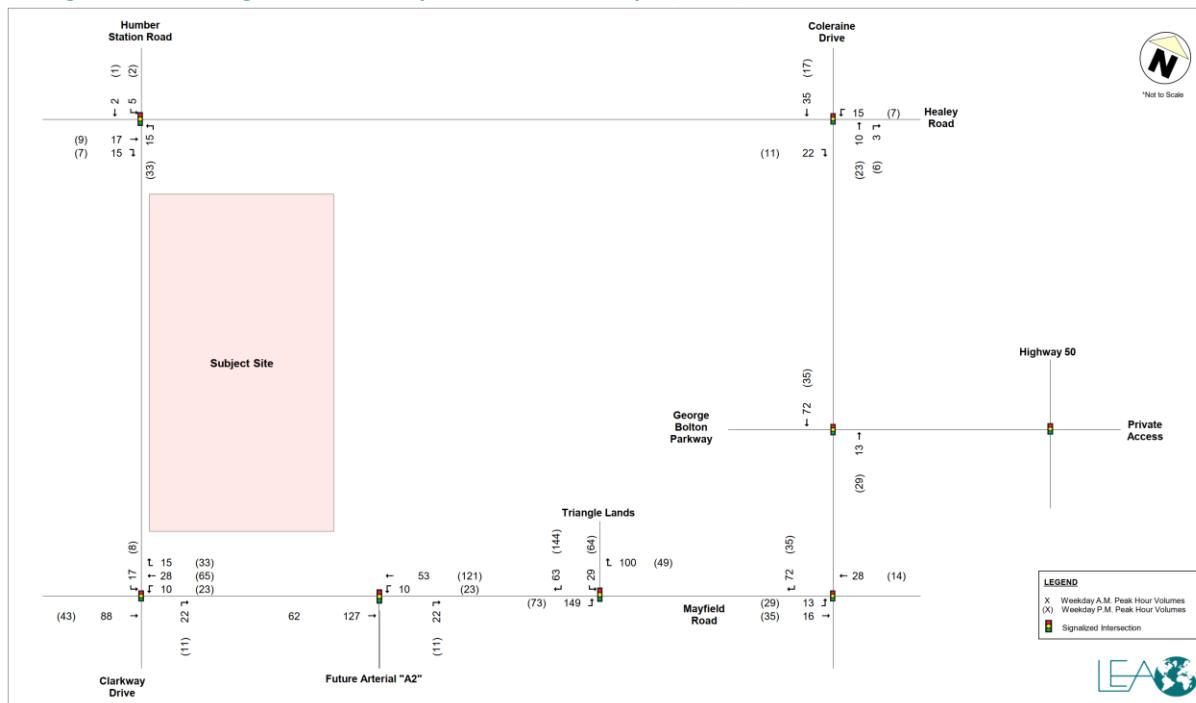



Triangle Lands Background Development Truck Trips (2043)

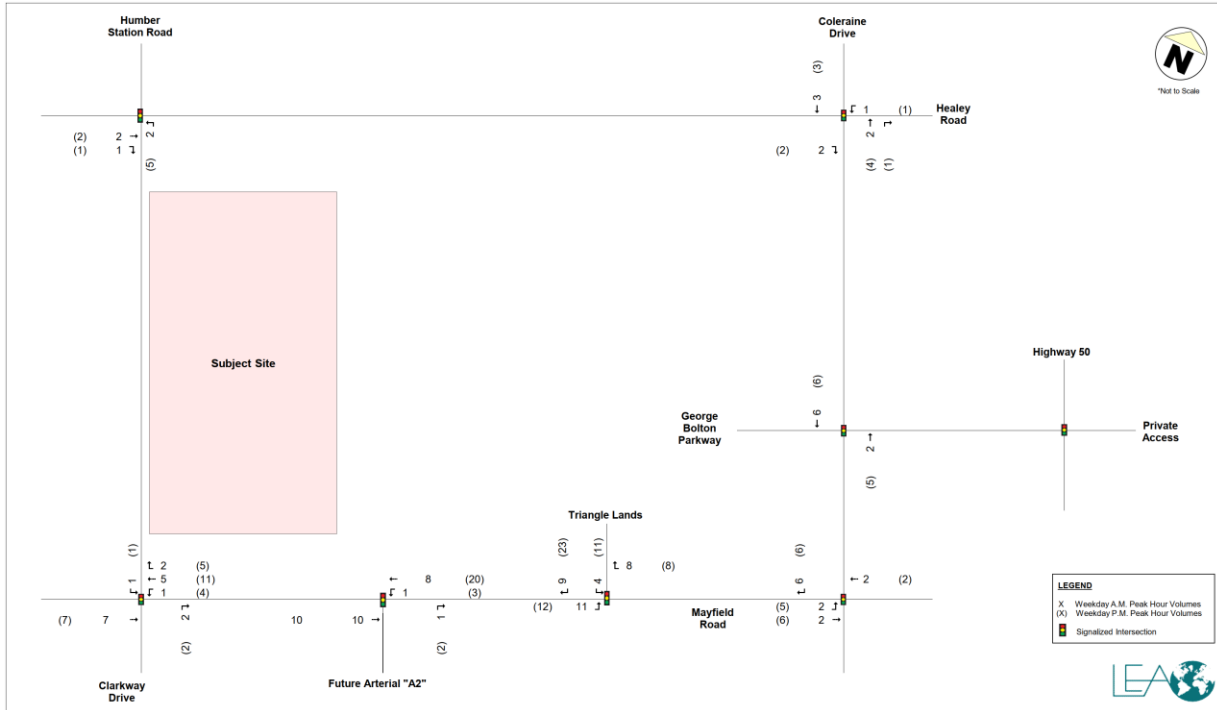



12563 & 12599 Highway 50 Background Development Trips (Phase 1 2033)

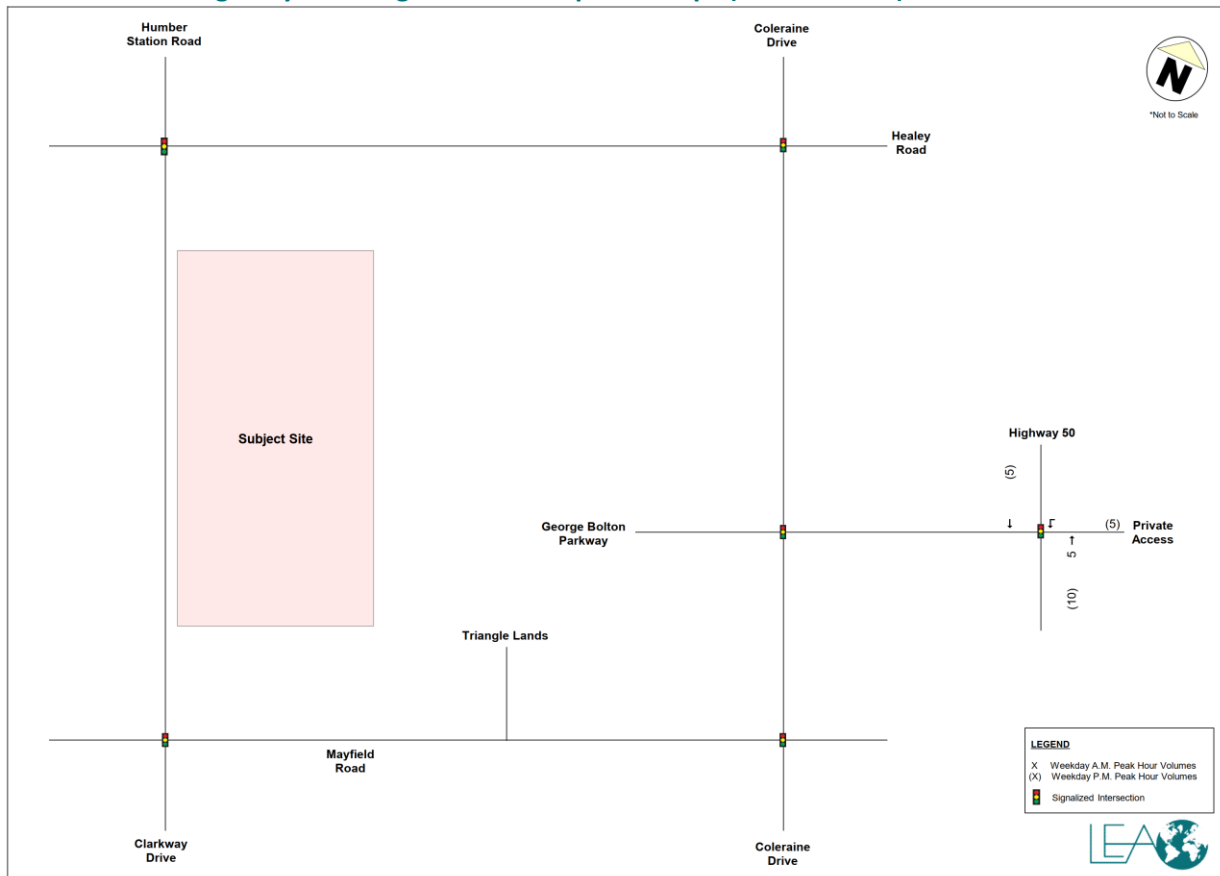



12563 & 12599 Highway 50 Background Development Trips (FBO 2036)

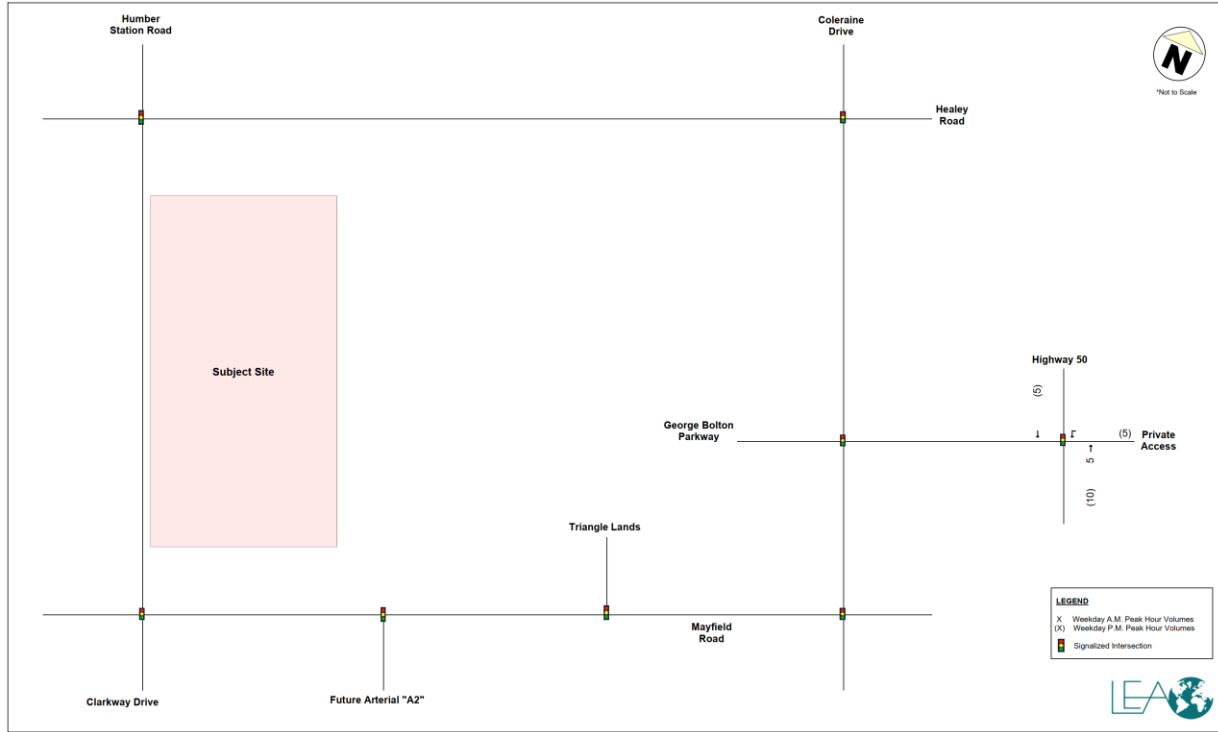



Coleraine Drive & Mayfield Road Block Plan Vehicle and Truck Trip Generation

Land Use	Description	Weekday AM Peak Hour			Weekday PM Peak Hour		
		In	Out	Total	In	Out	Total
Coleraine Drive and Mayfield Road Block Plan (Vehicle)							
ITE LUC 140 – Manufacturing 1066 Employees	Truck Trip Rate (/employee)	0.02	0.01	0.03	0.02	0.03	0.05
	Total ITE Auto Trips	19	13	32	20	34	54
	External Truck Trips (100%)	19	13	32	20	34	54
Coleraine Drive and Mayfield Road Block Plan (Truck)							
ITE LUC 140 – Manufacturing 598 Employees	Truck Trip Rate (/employee)	0.02	0.01	0.03	0.02	0.03	0.05
	Total ITE Auto Trips	11	7	18	11	19	30
	External Truck Trips (100%)	11	7	18	11	19	30

Coleraine Drive & Mayfield Road Block Plan Background Development Vehicle Trips (2028 & 2033)

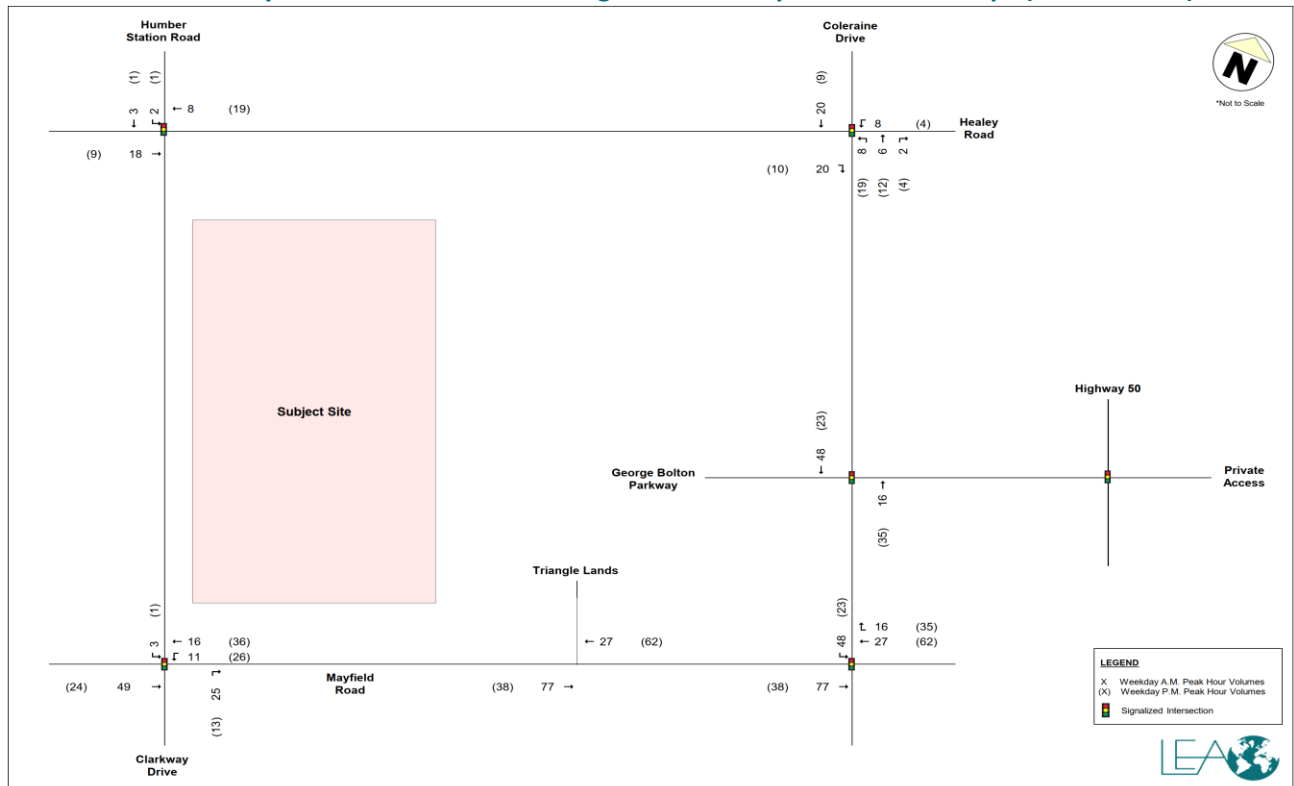



Coleraine Drive & Mayfield Road Block Plan Background Development Truck Trips (2028 & 2033)

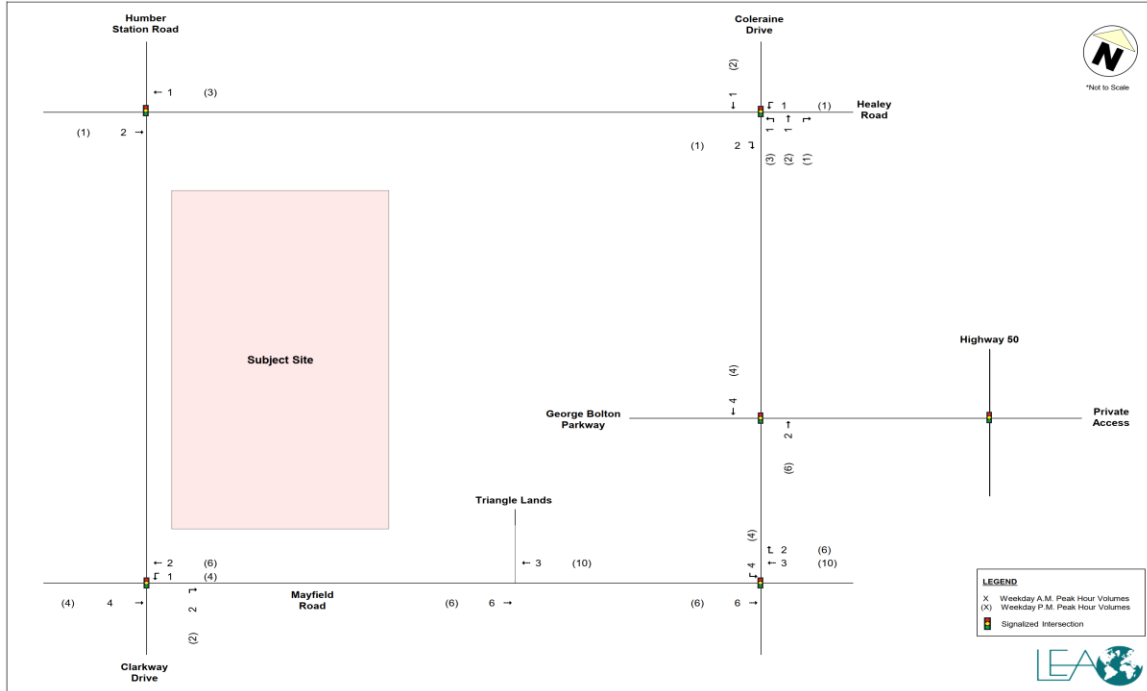

Coleraine Drive & Mayfield Road Block Plan Background Development Vehicle Trips (2043)

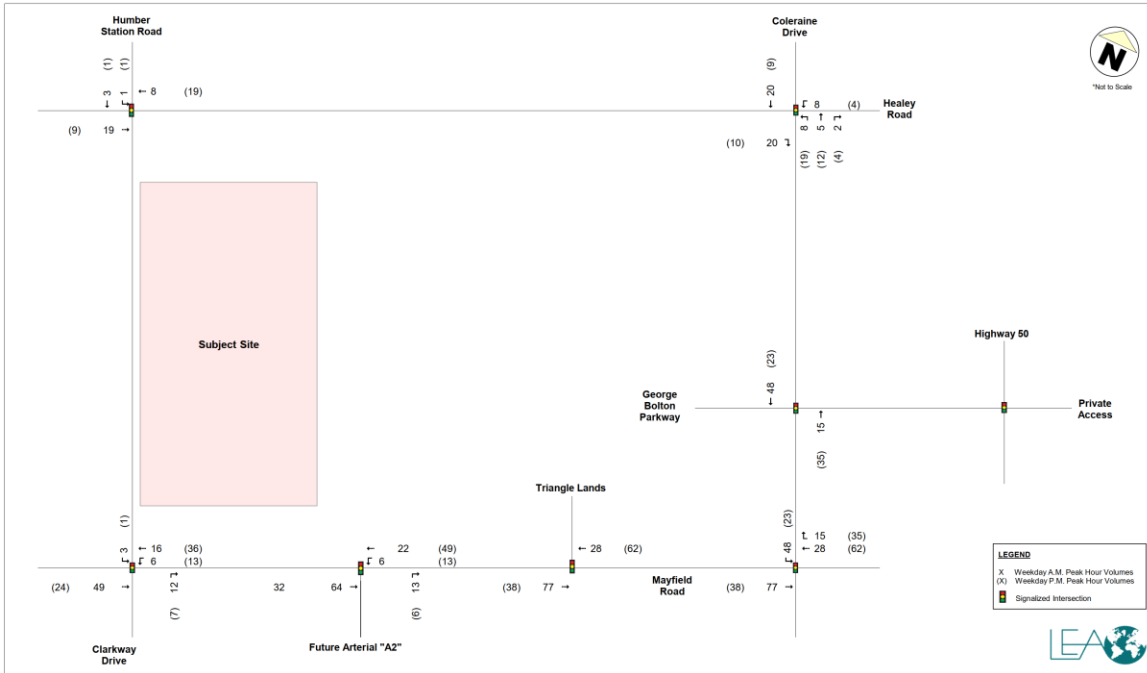



Coleraine Drive & Mayfield Road Block Plan Background Development Truck Trips (2043)

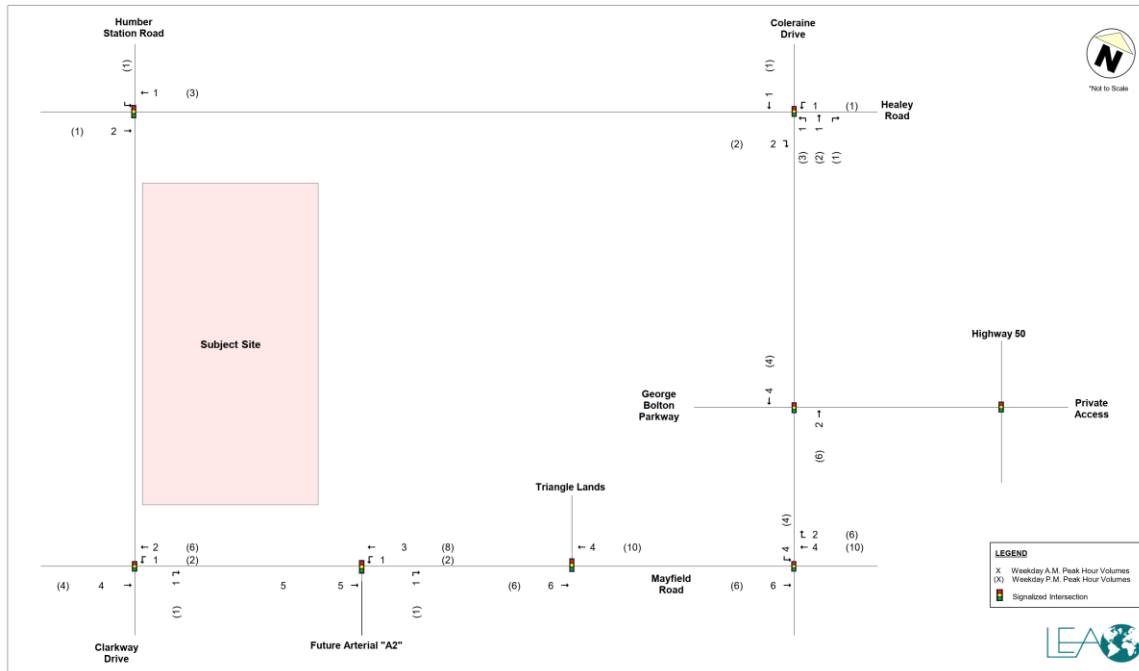



APPENDIX D

Corridor Growth Calculations

Intersection A

Intersection	Index	Movement	2021		2041	
			AM Peak	AM Corridor	AM Peak	AM Corridor
			1	2	NB	30
3	4	NB	0	0	0	0
5	6	SB	542	542	730	730
7	8	EB	0	0	0	0
9	10	WB	0	0	0	0
11	12	WB	0	0	0	0

AM							Growth	
Year	NB	SB	EB	WB	Overall	Street Name	NB	SB
2021	30	542	0	0	572	Number Station Rd (Screening by Bradford Rd)	0	0
2041	101	730	0	0	831		0	0

Calculated Growth Rates: 3.51% 1.29% #DIV/0! #DIV/0! 1.56%

Applied Growth Rates: 3.5% 0.0% 0.0% 0.0% 1.0%

Intersection	Index	Movement	2021		2041	
			AM Peak	AM Corridor	AM Peak	AM Corridor
			1	2	NB	30
3	4	NB	0	0	0	0
5	6	SB	659	659	585	585
7	8	EB	0	0	0	0
9	10	WB	0	0	0	0
11	12	WB	0	0	0	0

AM							Growth	
Year	NB	SB	EB	WB	Overall	Street Name	NB	SB
2021	30	659	0	0	689	Number Station Rd (Screening North of Bradley Rd)	0	0
2041	35	585	0	0	620		0	0

Calculated Growth Rates: 0.71% -0.63% #DIV/0! #DIV/0! -0.56%

Applied Growth Rates: 1.0% 0.0% 0.0% 0.0% 1.0%

Intersection	Index	Movement	2021		2041	
			AM Peak	AM Corridor	AM Peak	AM Corridor
			1	2	NB	0
3	4	SB	0	0	0	0
5	6	EB	193	193	616	616
7	8	WB	4	4	21	21
9	10	WB	0	0	0	0
11	12	WB	0	0	0	0

AM							Growth	
Year	NB	SB	EB	WB	Overall	Street Name	EB	WB
2021	0	0	193	4	197	Healey Rd (Screening west of Number Station Rd)	0	0
2041	0	0	616	21	637		0	0

Calculated Growth Rates: #DIV/0! #DIV/0! 3.43% 4.05% 3.45%

Applied Growth Rates: 0.0% 0.0% 0.0% 0.0% 0.0%

Intersection	Index	Movement	2021		2041	
			AM Peak	AM Corridor	AM Peak	AM Corridor
			1	2	NB	0
3	4	SB	0	0	0	0
5	6	EB	310	310	650	650
7	8	WB	5	5	21	21
9	10	WB	0	0	0	0
11	12	WB	0	0	0	0

AM							Growth	
Year	NB	SB	EB	WB	Overall	Street Name	EB	WB
2021	0	0	310	5	315	Healey Rd (Screening East of Number Station Rd)	0	0
2041	0	0	650	21	671		0	0

Calculated Growth Rates: #DIV/0! #DIV/0! 2.62% 3.91% 2.65%

Applied Growth Rates: 0.0% 0.0% 0.0% 0.0% 0.0%

Intersection	Index	Movement	2021		2041	
			AM Peak	AM Corridor	AM Peak	AM Corridor
			1	2	NB	0
3	4	SB	0	0	0	0
5	6	EB	797	797	0	0
7	8	WB	12	12	7	7
9	10	WB	0	0	0	0
11	12	WB	0	0	0	0

AM							Growth	
Year	NB	SB	EB	WB	Overall	Street Name	EB	WB
2021	0	0	797	12	809	George Bolton Pkwy (Screening by Coleraine Dr)	0	0
2041	0	0	0	7	7		0	0

Calculated Growth Rates: #DIV/0! #DIV/0! #DIV/0! 3.57% 572.86%

Applied Growth Rates: 0.0% 0.0% 0.0% 0.0% 0.0%

Intersection	Index	Movement	2021		2041	
			AM Peak	AM Corridor	AM Peak	AM Corridor
			1	2	NB	0
3	4	SB	0	0	0	0
5	6	EB	2	2	0	0
7	8	WB	12	12	0	0
9	10	WB	0	0	0	0
11	12	WB	0	0	0	0

AM							Growth	
Year	NB	SB	EB	WB	Overall	Street Name	EB	WB
2021	0	0	2	12	14	George Bolton Pkwy (Screening by Hwy 50)	0	0
2041	0	0	0	0	0		0	0

Calculated Growth Rates: #DIV/0! #DIV/0! #DIV/0! #DIV/0! #DIV/0!

Applied Growth Rates: 0.0% 0.0% 0.0% 0.0% 0.0%

Intersection	Index	Movement	2021		2041	
			AM Peak	AM Corridor	AM Peak	AM Corridor
			1	2	NB	0
3	4	SB	0	0	0	0
5	6	EB	0	0	34	34
7	8	WB	0	0	53	53
9	10	WB	0	0	0	0
11	12	WB	0	0	0	0

AM							Growth	
Year	NB	SB	EB	WB	Overall	Street Name	EB	WB
2021	0	0	0	0	0	George Bolton Pkwy (Screening at internal roads)	0	0
2041	0	0	34	53	87		0	0

Calculated Growth Rates: #DIV/0! #DIV/0! 5.00% 5.00% 5.00%

Applied Growth Rates: 0.0% 0.0% 0.0% 0.0% 0.0%

*Assuming no growth along George Bolton Pkwy

Intersection	Index	Movement	2021		2041	
			AM Peak	AM Corridor	AM Peak	AM Corridor
			1	2	NB	1089
3	4	SB	1126	1126	1164	1164
5	6	EB	0	0	0	0
7	8	WB	0	0	0	0
9	10	WB	0	0	0	0
11	12	WB	0	0	0	0

AM							Growth	
Year	NB	SB	EB	WB	Overall	Street Name	NB	SB
2021	1089	1126	0	0	2215	Hwy 50 (Screening South of George Bolton Pkwy)	0	0
2041	1452	1164	0	0	2616		0	0

Calculated Growth Rates: 1.25% 0.10% #DIV/0! #DIV/0! 0.77%

Applied Growth Rates: 1.0% 0.5% 0.0% 0.0% 0.0%

Intersection	Index	Movement	2021		2041	
			AM Peak	AM Corridor	AM Peak	AM Corridor
			1	2	NB	1087
3	4	SB	1135	1135	1217	1217
5	6	EB	0	0	0	0
7	8	WB	0	0	0	0
9	10	WB	0	0	0	0
11	12	WB	0	0	0	0

AM							Growth	
Year	NB	SB	EB	WB	Overall	Street Name	NB	SB
2021	1087	1135	0	0	2222	Hwy 50 (Screening North of George Bolton Pkwy)	0	0
2041	1486	1217	0	0	2703		0	0

Calculated Growth Rates: 1.34% 0.34% #DIV/0! #DIV/0! 0.89%

Applied Growth Rates: 1.0% 0.5% 0.0% 0.0% 0.0%

Intersection	Index	Movement	2021		2041	
			AM Peak	AM Corridor	AM Peak	AM Corridor
			1	2	NB	1029
3	4	SB	1226	1226	1084	1084
5	6	EB	0	0	0	0
7	8	WB	0	0	0	0
9	10	WB	0	0	0	0
11	12	WB	0	0	0	0

AM							Growth	
Year	NB	SB	EB	WB	Overall	Street Name	NB	SB
2021	1029	1226	0	0	2255	Coleraine Dr (Screening South of George Bolton Pkwy)	0	0
2041	693	1084	0	0	1777		0	0

Calculated Growth Rates: 1.00% 0.00%

Applied Growth Rates: 1.0% 0.0%

Intersection	Index	Movement	2021		2041	
			AM Peak	AM Corridor	AM Peak	AM Corridor
			1	2	NB	242
3	4	SB	1225	1225	1112	1112
5	6	EB	0	0	0	0
7	8	WB	0	0	0	0
9	10	WB	0	0	0	0
11	12	WB	0	0	0	0

AM							Growth	
Year	NB	SB	EB	WB	Overall	Street Name	NB	SB
2021	242	1225	0	0	1467	Coleraine Dr (Screening North of George Bolton Pkwy)	0	0
2041	747	1112	0	0	1859		0	0

Calculated Growth Rates: 1.00% 0.00%

Applied Growth Rates: 1.0% 0.0%

Calculated Growth Rates: 2.42% 0.65% #DIV/0! #DIV/0! -1.34%
 Applied Growth Rates: 1.0% 0.5% 0.0% 0.0% 0.0%

Intersection	Index	Movement	2021		2041	
			AM Peak	AM Corridor	AM Peak	AM Corridor
1 Coleman Dr (Screenline South of Healey Rd)	1					
	2	NB	248	248	1075	1075
	3					
	4					
	5	SB	1279		1346	1346
	6					
	7					
	8	EB		0		0
	9					
	10					
	11	WB		0		0
	12					

AM

Year	Street Name		Street Name		Overall
	NB	SB	EB	WB	
2021	248	1279	0	0	1527
2041	1075	1346	0	0	2421

Calculated Growth Rates: 3.85% 0.25% #DIV/0! #DIV/0! 1.85%
 Applied Growth Rates: 1.0% 0.5% 0.0% 0.0% 0.0%

Intersection	Index	Movement	2021		2041	
			AM Peak	AM Corridor	AM Peak	AM Corridor
1 Mayfield Rd (Screenline East of Humboldt Street Rd)	1					
	2	NB		0		0
	3					
	4					
	5	SB		0		0
	6					
	7					
	8	EB	1260	1260	2204	2204
	9					
	10	WB	802	402	910	910
	11					
	12					

AM

Year	Street Name		Street Name		Overall
	NB	SB	EB	WB	
2021	0	0	1260	802	1862
2041	0	0	2204	910	3114

Calculated Growth Rates: #DIV/0! #DIV/0! 2.14% 2.77% 2.33%
 Applied Growth Rates: 1.0% 0.5% 0.0% 0.0% 0.0%

Calculated Growth Rates: 3.38% -0.51% #DIV/0! #DIV/0! 1.05% 2.00% 0.00%
 Applied Growth Rates: 1.0% 0.5% 0.0% 0.0% 0.0% 2.0% 0.0%

Intersection	Index	Movement	2021		2041	
			AM Peak	AM Corridor	AM Peak	AM Corridor
1 Coleman Dr (Screenline North of Healey Rd)	1					
	2	NB	243	243	386	386
	3					
	4					
	5	SB	1616	1616	1714	1714
	6					
	7					
	8	EB		0		0
	9					
	10					
	11	WB		0		0
	12					

AM

Year	Street Name		Street Name		Overall
	NB	SB	EB	WB	
2021	243	1616	0	0	1859
2041	386	1714	0	0	2100

Calculated Growth Rates: 1.85% 0.29% #DIV/0! #DIV/0! 0.57%
 Applied Growth Rates: 1.0% 0.5% 0.0% 0.0% 0.0%

Intersection	Index	Movement	2021		2041	
			AM Peak	AM Corridor	AM Peak	AM Corridor
1 Mayfield Rd (Screenline West of Coleman Dr)	1					
	2	NB		0		0
	3					
	4					
	5	SB		0		0
	6					
	7					
	8	EB	1124	1124	1832	1832
	9					
	10	WB	398	398	715	715
	11					
	12					

AM

Year	Street Name		Street Name		Overall
	NB	SB	EB	WB	
2021	0	0	1124	398	1522
2041	0	0	1832	715	2547

Calculated Growth Rates: #DIV/0! #DIV/0! 1.93% 2.22% 2.01%
 Applied Growth Rates: 1.0% 0.5% 0.0% 0.0% 0.0%

Intersection	Index	Movement	2021		2041	
			AM Peak	AM Corridor	AM Peak	AM Corridor
1 Mayfield Rd (Screenline East of Coleman Dr)	1					
	2	NB		0		0
	3					
	4					
	5	SB		0		0
	6					
	7					
	8	EB	212	212	741	741
	9					
	10	WB	193	193	313	313
	11					
	12					

AM

Year	Street Name		Street Name		Overall
	NB	SB	EB	WB	
2021	0	0	212	193	405
2041	0	0	741	313	1054

Calculated Growth Rates: #DIV/0! #DIV/0! 3.57% 1.92% 1.06% 3.00% 2.00%
 Applied Growth Rates: 1.0% 0.5% 0.0% 0.0% 0.0% 3.0% 2.0%



APPENDIX E

Mayfield Widening Correspondences

Christy Leung

From: Kabanov, Serguei <serguei.kabanov@peelregion.ca>
Sent: August 28, 2023 4:36 PM
To: Christy Leung
Cc: Marzo, Christina; Sadek, Sandra
Subject: RE: Option 6 Lands: Mayfield Widening Timing

External Sender

Good Afternoon Christy,

I'm the Regional PM looking after Mayfield Road Widening, from Airport to Coleraine. Christina forwarded me your email with questions.

1. Mayfield Road widening, between Humber Station Road and Coleraine is scheduled for construction in 2026. The project will start at Airport so chances are we won't be doing the stretch you are concerned about until 2027 or later. The stretch from Coleraine to Highway 50 is a separate project and, as of right now, it is scheduled for late 2026 or early 2027. My colleague Sandra, copied on this email, is looking after this project.
2. I can confirm that the jogged intersection at Humber Station Road & Mayfield Road will be addressed with the widening of Mayfield.

If you have any further questions, please do not hesitate to reach out directly.

Serguei Kabanov, CD, CET, rcca
Project Manager, Roads Design and Construction

From: Christy Leung <ChLeung@lea.ca>
Sent: August 28, 2023 2:48 PM
To: Marzo, Christina <christina.marzo@peelregion.ca>
Cc: Chris Sidlar <CSidlar@lea.ca>
Subject: Option 6 Lands: Mayfield Widening Timing

CAUTION: EXTERNAL MAIL. DO NOT CLICK ON LINKS OR OPEN ATTACHMENTS YOU DO NOT TRUST.

Hi Christina,

If you recall, the Region met with our office earlier this month to discuss the road improvements surrounding the Option 6 lands in Caledon. Further to that discussion, I wanted to confirm timing of the Mayfield Road widening between Humber Station Road and Highway 50. As per the Region's Long Range Transportation Plan, Mayfield is planned to widen by 2031. Given the observed construction activity along this stretch of the roadway, has timing of this improvement moved up in schedule?

Can you also confirm that the jogged intersection at Humber Station Road & Mayfield Road will be addressed with the widening of Mayfield?

Thanks,



APPENDIX F

TTS Data



APPENDIX G

LOS Definitions

LEVELS OF SERVICE FOR SIGNALIZED INTERSECTIONS: METHODOLOGY

Signalized intersection analyses contained in this report were carried out using methodology described in the *Highway Capacity Manual, 2000 update*, by the Transportation Research Board and implemented using Synchro 11 software.

Analyses of signalized intersections compare the volume of traffic passing through an intersection with the capacity of each of the intersection's approaches. Volumes can be either observed or estimated whereas an intersection's capacity is a function of its geometry, the number of lanes per approach, speeds, signal timing, and other considerations. The level of service is evaluated in terms of the average control delay (seconds) per vehicle, which is a measure of driver discomfort, frustration, fuel consumption, and lost travel time. Delay is a complex measure and is calculated as a function of a number of variables, including the quality of progression, the cycle length, the green ratio, and the v/c ratio for the lane group in question.

The criteria for each level of service are given below.

Level of Service	Features	Control Delay (sec/veh)
A	Very low control delay. Occurs when signal progression (i.e. coordination) is extremely favorable and most vehicles arrive during the green phase. Most vehicles do not have to stop.	0.0 – 10.0
B	Occurs with good progression, short cycle length, or both. More vehicles stop than with LOS A.	10.1 – 20.0
C	Occurs with fair progression, longer cycle length, or both. Individual cycle failures may begin to appear. The number of vehicles stopping is significant at this level, though many still pass through the intersection without stopping.	20.0 – 35.0
D	The influence of congestion becomes more noticeable. Longer delays may result from some combination of unfavorable progression, long cycle lengths, or high v/c ratios. Many vehicles have to stop. Individual cycle failures are noticeable (i.e. some vehicles require more than one cycle to make it through the intersection).	35.0 – 55.0
E	Considered by many agencies to be the limit of acceptable delay. High delay values generally indicate poor progression, long cycle lengths, and high v/c ratios. Individual cycle failures are frequent occurrences.	55.0- 80.0
F	Considered to be unacceptable to most drivers and often occurs with oversaturation. It may also occur at high v/c ratios below 1.0 with many individual cycle failures.	80.1 +

LEVELS OF SERVICE FOR UNSIGNALIZED INTERSECTIONS: METHODOLOGY

Unsignalized intersection analyses contained in this report were carried out using methodology described in the *Highway Capacity Manual (2000 edition)* by the Transportation Research Board and implemented using the Synchro 11 software.

Analyses of unsignalized intersections compare observed or estimated traffic volumes with the capacity of each of the intersection’s approaches. The analysis derives an estimation of queue lengths and the resulting delays experienced by vehicles from the time they join a queue to the moment they cross the stop bar at the intersection. Queuing and delays at unsignalized approaches are a function of the volumes of all other conflicting movements and the characteristics of the intersection. Traffic volumes can be either observed or estimated while an intersection’s capacity is a function of its geometry, lane configurations, speeds, and other operational considerations. The resulting statistic is termed “average total delay” for each approach and is measured in seconds per vehicle. The delay can then be assigned a letter grade, which provides a simple qualitative assessment of the Level of Service for any unsignalized intersection.

The Level of Service grading for unsignalized intersections is more sensitive than that used for signalized analyses: delays are more onerous at unsignalized intersections as drivers must remain attentive while waiting for acceptable conditions to complete their movement. As a result, the thresholds between grades are lower for unsignalized analyses.

Level of Service	Features	Average Total Delay (sec/veh)
A	Almost no delay occurs. Approaches appear clear and turns are made easily.	0.0 – 10.0
B	Short delays are experienced. Drivers find their movement becoming more restricted.	10.1 – 15.0
C	Longer delays occur. Operation of both the minor and major streets are generally stable but movements from the minor street become more difficult. This level is often used for urban intersection design standards.	15.1 – 25.0
D	Motorists encounter increasing traffic restrictions and substantial delays. Delays on the major street occur as turning traffic interferes with the flow of traffic. Traffic flows are approaching the capacity of the intersection.	25.1 - 35.0
E	At level “E”, capacity is reached. There are long queues of vehicles waiting upstream for the approach to clear. Delays to vehicles reach frustrating levels.	35.1- 50.0
F	Intersection saturation occurs as vehicle demand has exceeded the capacity. Drivers will often accept less than ideal gap opportunities; safety is compromised.	50.1 +



APPENDIX H

Existing Intersection Capacity Analysis

Queues
1: Coleraine Drive & Healey Road

Existing Traffic
AM Peak Hour



Lane Group	EBL	EBT	WBL	WBT	NBL	NBT	SBL	SBT
Lane Configurations	↖	↗	↖	↗	↖	↕	↖	↕
Traffic Volume (vph)	121	296	24	101	26	101	64	265
Future Volume (vph)	121	296	24	101	26	101	64	265
Lane Group Flow (vph)	130	529	26	133	28	133	69	459
Turn Type	Perm	NA	Perm	NA	Perm	NA	Perm	NA
Protected Phases		8		4		6		2
Permitted Phases	8		4		6		2	
Detector Phase	8	8	4	4	6	6	2	2
Switch Phase								
Minimum Initial (s)	8.0	8.0	8.0	8.0	8.0	8.0	8.0	8.0
Minimum Split (s)	32.8	32.8	32.8	32.8	36.7	36.7	36.7	36.7
Total Split (s)	33.0	33.0	33.0	33.0	37.0	37.0	37.0	37.0
Total Split (%)	47.1%	47.1%	47.1%	47.1%	52.9%	52.9%	52.9%	52.9%
Yellow Time (s)	4.0	4.0	4.0	4.0	4.6	4.6	4.6	4.6
All-Red Time (s)	2.8	2.8	2.8	2.8	2.1	2.1	2.1	2.1
Lost Time Adjust (s)	0.0	0.0	0.0	0.0	0.0	0.0	0.0	0.0
Total Lost Time (s)	6.8	6.8	6.8	6.8	6.7	6.7	6.7	6.7
Lead/Lag								
Lead-Lag Optimize?								
Recall Mode	None	None	None	None	C-Max	C-Max	C-Max	C-Max
v/c Ratio	0.34	0.86	0.28	0.25	0.07	0.11	0.16	0.30
Control Delay	19.3	34.6	24.6	14.8	12.1	9.7	13.1	8.0
Queue Delay	0.0	0.0	0.0	0.0	0.0	0.0	0.0	0.0
Total Delay	19.3	34.6	24.6	14.8	12.1	9.7	13.1	8.0
Queue Length 50th (m)	12.7	57.9	2.5	10.8	2.1	4.3	5.4	12.0
Queue Length 95th (m)	25.3	#105.4	8.9	21.9	6.7	9.4	13.4	21.8
Internal Link Dist (m)		1349.5		424.0		1711.9		1121.0
Turn Bay Length (m)	55.0		50.0		80.0		155.0	
Base Capacity (vph)	433	687	105	607	411	1184	440	1521
Starvation Cap Reductn	0	0	0	0	0	0	0	0
Spillback Cap Reductn	0	0	0	0	0	0	0	0
Storage Cap Reductn	0	0	0	0	0	0	0	0
Reduced v/c Ratio	0.30	0.77	0.25	0.22	0.07	0.11	0.16	0.30

Intersection Summary

Cycle Length: 70
 Actuated Cycle Length: 70
 Offset: 6 (9%), Referenced to phase 2:SBTL and 6:NBTL, Start of Green
 Natural Cycle: 70
 Control Type: Actuated-Coordinated
 # 95th percentile volume exceeds capacity, queue may be longer.
 Queue shown is maximum after two cycles.



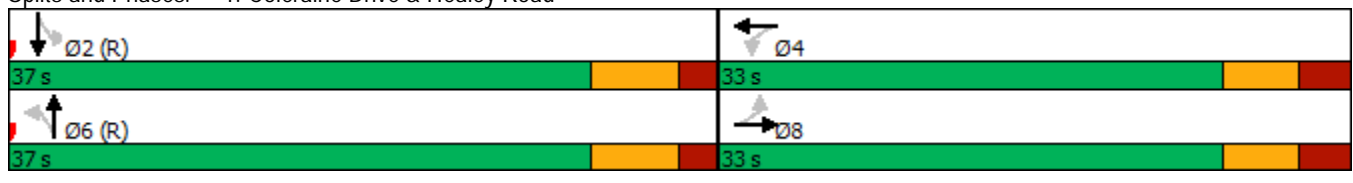



















Splits and Phases: 1: Coleraine Drive & Healey Road



HCM Signalized Intersection Capacity Analysis

1: Coleraine Drive & Healey Road

















Existing Traffic
AM Peak Hour

												
Movement	EBL	EBT	EBR	WBL	WBT	WBR	NBL	NBT	NBR	SBL	SBT	SBR
Lane Configurations												
Traffic Volume (vph)	121	296	196	24	101	22	26	101	22	64	265	162
Future Volume (vph)	121	296	196	24	101	22	26	101	22	64	265	162
Ideal Flow (vphpl)	1900	1900	1900	1900	1900	1900	1900	1900	1900	1900	1900	1900
Lane Width	3.0	3.5	3.0	3.0	3.5	3.0	3.0	3.5	3.0	3.0	3.5	3.0
Total Lost time (s)	6.8	6.8		6.8	6.8		6.7	6.7		6.7	6.7	
Lane Util. Factor	1.00	1.00		1.00	1.00		1.00	0.95		1.00	0.95	
Frt	1.00	0.94		1.00	0.97		1.00	0.97		1.00	0.94	
Flt Protected	0.95	1.00		0.95	1.00		0.95	1.00		0.95	1.00	
Satd. Flow (prot)	1636	1745		1267	1593		1685	2463		1316	3008	
Flt Permitted	0.67	1.00		0.21	1.00		0.49	1.00		0.67	1.00	
Satd. Flow (perm)	1157	1745		283	1593		865	2463		925	3008	
Peak-hour factor, PHF	0.93	0.93	0.93	0.93	0.93	0.93	0.93	0.93	0.93	0.93	0.93	0.93
Adj. Flow (vph)	130	318	211	26	109	24	28	109	24	69	285	174
RTOR Reduction (vph)	0	37	0	0	12	0	0	13	0	0	91	0
Lane Group Flow (vph)	130	492	0	26	121	0	28	120	0	69	368	0
Heavy Vehicles (%)	3%	2%	0%	33%	3%	68%	0%	45%	23%	28%	18%	2%
Turn Type	Perm	NA		Perm	NA		Perm	NA		Perm	NA	
Protected Phases		8			4			6			2	
Permitted Phases	8			4			6			2		
Actuated Green, G (s)	23.2	23.2		23.2	23.2		33.3	33.3		33.3	33.3	
Effective Green, g (s)	23.2	23.2		23.2	23.2		33.3	33.3		33.3	33.3	
Actuated g/C Ratio	0.33	0.33		0.33	0.33		0.48	0.48		0.48	0.48	
Clearance Time (s)	6.8	6.8		6.8	6.8		6.7	6.7		6.7	6.7	
Vehicle Extension (s)	3.0	3.0		3.0	3.0		3.0	3.0		3.0	3.0	
Lane Grp Cap (vph)	383	578		93	527		411	1171		440	1430	
v/s Ratio Prot		c0.28			0.08			0.05			c0.12	
v/s Ratio Perm	0.11			0.09			0.03			0.07		
v/c Ratio	0.34	0.85		0.28	0.23		0.07	0.10		0.16	0.26	
Uniform Delay, d1	17.6	21.8		17.2	16.9		9.9	10.1		10.4	11.0	
Progression Factor	1.00	1.00		1.00	1.00		1.00	1.00		1.00	1.00	
Incremental Delay, d2	0.5	11.6		1.6	0.2		0.3	0.2		0.8	0.4	
Delay (s)	18.2	33.4		18.9	17.2		10.3	10.3		11.2	11.4	
Level of Service	B	C		B	B		B	B		B	B	
Approach Delay (s)		30.4			17.4			10.3			11.4	
Approach LOS		C			B			B			B	
Intersection Summary												
HCM 2000 Control Delay			20.2				HCM 2000 Level of Service				C	
HCM 2000 Volume to Capacity ratio			0.50									
Actuated Cycle Length (s)			70.0				Sum of lost time (s)				13.5	
Intersection Capacity Utilization			75.9%				ICU Level of Service				D	
Analysis Period (min)			15									

c Critical Lane Group

HCM Unsignalized Intersection Capacity Analysis
2: Humber Station Road & Healey Road

Existing Traffic
AM Peak Hour

												
Movement	EBL	EBT	EBR	WBL	WBT	WBR	NBL	NBT	NBR	SBL	SBT	SBR
Lane Configurations												
Sign Control		Stop			Stop			Stop			Stop	
Traffic Volume (vph)	4	499	19	73	210	4	6	16	31	72	162	4
Future Volume (vph)	4	499	19	73	210	4	6	16	31	72	162	4
Peak Hour Factor	0.93	0.93	0.93	0.93	0.93	0.93	0.93	0.93	0.93	0.93	0.93	0.93
Hourly flow rate (vph)	4	537	20	78	226	4	6	17	33	77	174	4
Direction, Lane #	EB 1	WB 1	NB 1	SB 1								
Volume Total (vph)	561	308	56	255								
Volume Left (vph)	4	78	6	77								
Volume Right (vph)	20	4	33	4								
Hadj (s)	0.02	0.08	-0.30	0.06								
Departure Headway (s)	5.6	6.0	6.8	6.5								
Degree Utilization, x	0.87	0.51	0.11	0.46								
Capacity (veh/h)	637	557	455	517								
Control Delay (s)	33.9	15.2	10.6	15.0								
Approach Delay (s)	33.9	15.2	10.6	15.0								
Approach LOS	D	C	B	C								
Intersection Summary												
Delay			23.8									
Level of Service			C									
Intersection Capacity Utilization			72.4%		ICU Level of Service				C			
Analysis Period (min)			15									

Queues

Existing Traffic

3: Clarkway Drive/Humber Station Road & Mayfield Road

AM Peak Hour



Lane Group	EBL	EBT	WBL	WBT	NBT	SBT
Lane Configurations		↕		↕	↕	↕
Traffic Volume (vph)	8	523	67	470	47	247
Future Volume (vph)	8	523	67	470	47	247
Lane Group Flow (vph)	0	582	0	564	177	267
Turn Type	Perm	NA	Perm	NA	NA	NA
Protected Phases		2		6	4	3
Permitted Phases	2		6			
Detector Phase	2	2	6	6	4	3
Switch Phase						
Minimum Initial (s)	12.0	12.0	12.0	12.0	8.0	8.0
Minimum Split (s)	27.3	27.3	27.3	27.3	26.0	27.5
Total Split (s)	70.0	70.0	70.0	70.0	20.0	30.0
Total Split (%)	58.3%	58.3%	58.3%	58.3%	16.7%	25.0%
Yellow Time (s)	4.6	4.6	4.6	4.6	4.2	4.2
All-Red Time (s)	2.7	2.7	2.7	2.7	2.8	2.8
Lost Time Adjust (s)		0.0		0.0	0.0	0.0
Total Lost Time (s)		7.3		7.3	7.0	7.0
Lead/Lag					Lag	Lead
Lead-Lag Optimize?					Yes	Yes
Recall Mode	C-Max	C-Max	C-Max	C-Max	None	None
v/c Ratio		0.72		0.79	0.89	0.83
Control Delay		27.8		32.9	91.9	69.5
Queue Delay		0.0		0.0	0.0	0.0
Total Delay		27.8		32.9	91.9	69.5
Queue Length 50th (m)		106.1		109.9	44.4	63.3
Queue Length 95th (m)		153.1		164.5	#91.7	#101.1
Internal Link Dist (m)		912.9		1363.4	257.8	3037.3
Turn Bay Length (m)						
Base Capacity (vph)		812		716	200	354
Starvation Cap Reductn		0		0	0	0
Spillback Cap Reductn		0		0	0	0
Storage Cap Reductn		0		0	0	0
Reduced v/c Ratio		0.72		0.79	0.89	0.75

Intersection Summary

Cycle Length: 120
 Actuated Cycle Length: 120
 Offset: 31 (26%), Referenced to phase 2:EBTL and 6:WBTL, Start of Green
 Natural Cycle: 105
 Control Type: Actuated-Coordinated
 # 95th percentile volume exceeds capacity, queue may be longer.
 Queue shown is maximum after two cycles.

Splits and Phases: 3: Clarkway Drive/Humber Station Road & Mayfield Road

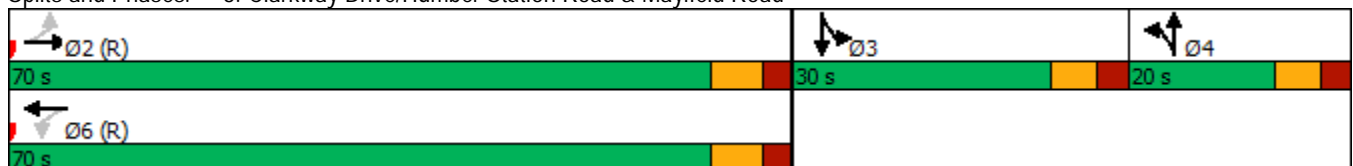

HCM Signalized Intersection Capacity Analysis
 3: Clarkway Drive/Humber Station Road & Mayfield Road

Existing Traffic
 AM Peak Hour



Movement	EBL	EBT	EBR	WBL	WBT	WBR	NBL	NBT	NBR	SBL	SBT	SBR
Lane Configurations		↕			↕			↕			↕	
Traffic Volume (vph)	8	523	28	67	470	4	11	47	112	2	247	8
Future Volume (vph)	8	523	28	67	470	4	11	47	112	2	247	8
Ideal Flow (vphpl)	1900	1900	1900	1900	1900	1900	1900	1900	1900	1900	1900	1900
Lane Width	3.0	3.5	3.0	3.0	3.5	3.0	3.0	3.5	3.0	3.0	3.5	3.0
Total Lost time (s)		7.3			7.3			7.0			7.0	
Lane Util. Factor		1.00			1.00			1.00			1.00	
Frt		0.99			1.00			0.91			1.00	
Flt Protected		1.00			0.99			1.00			1.00	
Satd. Flow (prot)		1552			1583			1646			1846	
Flt Permitted		0.99			0.85			1.00			1.00	
Satd. Flow (perm)		1540			1360			1646			1846	
Peak-hour factor, PHF	0.96	0.96	0.96	0.96	0.96	0.96	0.96	0.96	0.96	0.96	0.96	0.96
Adj. Flow (vph)	8	545	29	70	490	4	11	49	117	2	257	8
RTOR Reduction (vph)	0	1	0	0	0	0	0	0	0	0	0	0
Lane Group Flow (vph)	0	581	0	0	564	0	0	177	0	0	267	0
Heavy Vehicles (%)	13%	20%	25%	4%	20%	0%	18%	2%	3%	50%	1%	0%
Turn Type	Perm	NA		Perm	NA		Split	NA		Split	NA	
Protected Phases		2			6		4	4		3	3	
Permitted Phases	2			6								
Actuated Green, G (s)		63.2			63.2			14.6			20.9	
Effective Green, g (s)		63.2			63.2			14.6			20.9	
Actuated g/C Ratio		0.53			0.53			0.12			0.17	
Clearance Time (s)		7.3			7.3			7.0			7.0	
Vehicle Extension (s)		3.0			3.0			3.0			3.0	
Lane Grp Cap (vph)		811			716			200			321	
v/s Ratio Prot								c0.11			c0.14	
v/s Ratio Perm		0.38			c0.41							
v/c Ratio		0.72			0.79			0.89			0.83	
Uniform Delay, d1		21.6			23.0			51.9			47.9	
Progression Factor		1.00			1.00			1.00			1.00	
Incremental Delay, d2		5.4			8.6			33.8			16.6	
Delay (s)		26.9			31.5			85.7			64.4	
Level of Service		C			C			F			E	
Approach Delay (s)		26.9			31.5			85.7			64.4	
Approach LOS		C			C			F			E	
Intersection Summary												
HCM 2000 Control Delay			41.4									D
HCM 2000 Volume to Capacity ratio			0.81									
Actuated Cycle Length (s)			120.0						21.3			
Intersection Capacity Utilization			93.9%									F
Analysis Period (min)			15									

c Critical Lane Group

Queues

Existing Traffic

4: Coleraine Drive & Mayfield Road

AM Peak Hour

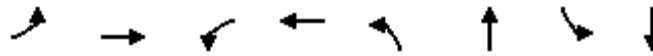

Lane Group	EBL	EBT	WBL	WBT	NBL	NBT	SBL	SBT
Lane Configurations	↖	↕	↖	↕	↖	↕	↖	↕
Traffic Volume (vph)	234	336	44	403	20	121	15	339
Future Volume (vph)	234	336	44	403	20	121	15	339
Lane Group Flow (vph)	266	439	50	481	23	148	17	537
Turn Type	pm+pt	NA	Perm	NA	Perm	NA	pm+pt	NA
Protected Phases	5	2		6		4	3	8
Permitted Phases	2		6		4		8	
Detector Phase	5	2	6	6	4	4	3	8
Switch Phase								
Minimum Initial (s)	5.0	12.0	12.0	12.0	12.0	12.0	5.0	12.0
Minimum Split (s)	8.0	37.0	37.0	37.0	37.0	37.0	9.5	37.0
Total Split (s)	15.0	80.0	65.0	65.0	32.0	32.0	18.0	50.0
Total Split (%)	11.5%	61.5%	50.0%	50.0%	24.6%	24.6%	13.8%	38.5%
Yellow Time (s)	3.0	4.6	4.6	4.6	4.2	4.2	3.0	4.2
All-Red Time (s)	0.0	2.4	2.4	2.4	2.8	2.8	0.0	2.8
Lost Time Adjust (s)	0.0	0.0	0.0	0.0	0.0	0.0	0.0	0.0
Total Lost Time (s)	3.0	7.0	7.0	7.0	7.0	7.0	3.0	7.0
Lead/Lag	Lead		Lag	Lag	Lag	Lag	Lead	
Lead-Lag Optimize?	Yes		Yes	Yes	Yes	Yes	Yes	
Recall Mode	None	C-Max	C-Max	C-Max	None	None	None	None
v/c Ratio	0.44	0.21	0.10	0.26	0.27	0.26	0.09	0.80
Control Delay	8.8	7.4	16.2	15.6	58.3	47.9	38.2	54.3
Queue Delay	0.0	0.0	0.0	0.0	0.0	0.0	0.0	0.0
Total Delay	8.8	7.4	16.2	15.6	58.3	47.9	38.2	54.3
Queue Length 50th (m)	21.1	19.1	5.8	32.2	5.3	17.1	3.6	67.1
Queue Length 95th (m)	37.0	29.8	15.1	51.7	14.9	28.4	9.6	80.6
Internal Link Dist (m)		1363.4		205.9		192.7		576.8
Turn Bay Length (m)	100.0		85.0		105.0		145.0	
Base Capacity (vph)	614	2064	503	1836	101	681	209	1105
Starvation Cap Reductn	0	0	0	0	0	0	0	0
Spillback Cap Reductn	0	0	0	0	0	0	0	0
Storage Cap Reductn	0	0	0	0	0	0	0	0
Reduced v/c Ratio	0.43	0.21	0.10	0.26	0.23	0.22	0.08	0.49

Intersection Summary

Cycle Length: 130

Actuated Cycle Length: 130

Offset: 92 (71%), Referenced to phase 2:EBTL and 6:WBTL, Start of Green

Natural Cycle: 95

Control Type: Actuated-Coordinated

























Splits and Phases: 4: Coleraine Drive & Mayfield Road



HCM Signalized Intersection Capacity Analysis

4: Coleraine Drive & Mayfield Road

Existing Traffic
AM Peak Hour

												
Movement	EBL	EBT	EBR	WBL	WBT	WBR	NBL	NBT	NBR	SBL	SBT	SBR
Lane Configurations		 			 			 			 	
Traffic Volume (vph)	234	336	50	44	403	20	20	121	9	15	339	134
Future Volume (vph)	234	336	50	44	403	20	20	121	9	15	339	134
Ideal Flow (vphpl)	1900	1900	1900	1900	1900	1900	1900	1900	1900	1900	1900	1900
Lane Width	3.0	3.5	3.0	3.0	3.5	3.0	3.0	3.5	3.0	3.0	3.5	3.0
Total Lost time (s)	3.0	7.0		7.0	7.0		7.0	7.0		3.0	7.0	
Lane Util. Factor	1.00	0.95		1.00	0.95		1.00	0.95		1.00	0.95	
Flt	1.00	0.98		1.00	0.99		1.00	0.99		1.00	0.96	
Flt Protected	0.95	1.00		0.95	1.00		0.95	1.00		0.95	1.00	
Satd. Flow (prot)	1546	2953		1685	3208		1532	3508		1146	3244	
Flt Permitted	0.44	1.00		0.50	1.00		0.33	1.00		0.57	1.00	
Satd. Flow (perm)	721	2953		882	3208		530	3508		693	3244	
Peak-hour factor, PHF	0.88	0.88	0.88	0.88	0.88	0.88	0.88	0.88	0.88	0.88	0.88	0.88
Adj. Flow (vph)	266	382	57	50	458	23	23	138	10	17	385	152
RTOR Reduction (vph)	0	7	0	0	2	0	0	4	0	0	38	0
Lane Group Flow (vph)	266	432	0	50	479	0	23	144	0	17	499	0
Heavy Vehicles (%)	9%	21%	2%	0%	9%	40%	10%	0%	11%	47%	0%	19%
Turn Type	pm+pt	NA		Perm	NA		Perm	NA		pm+pt	NA	
Protected Phases	5	2			6			4		3	8	
Permitted Phases	2			6			4			8		
Actuated Green, G (s)	88.8	88.8		72.5	72.5		20.7	20.7		27.2	27.2	
Effective Green, g (s)	88.8	88.8		72.5	72.5		20.7	20.7		27.2	27.2	
Actuated g/C Ratio	0.68	0.68		0.56	0.56		0.16	0.16		0.21	0.21	
Clearance Time (s)	3.0	7.0		7.0	7.0		7.0	7.0		3.0	7.0	
Vehicle Extension (s)	3.0	3.0		3.0	3.0		3.0	3.0		3.0	3.0	
Lane Grp Cap (vph)	576	2017		491	1789		84	558		157	678	
v/s Ratio Prot	c0.05	0.15			0.15			0.04		0.00	c0.15	
v/s Ratio Perm	c0.27			0.06			0.04			0.02		
v/c Ratio	0.46	0.21		0.10	0.27		0.27	0.26		0.11	0.74	
Uniform Delay, d1	8.1	7.6		13.5	14.9		48.0	47.9		41.3	48.0	
Progression Factor	1.00	1.00		1.00	1.00		1.00	1.00		1.00	1.00	
Incremental Delay, d2	0.6	0.2		0.4	0.4		1.8	0.2		0.3	4.2	
Delay (s)	8.6	7.9		13.9	15.3		49.8	48.2		41.6	52.2	
Level of Service	A	A		B	B		D	D		D	D	
Approach Delay (s)		8.2			15.2			48.4			51.9	
Approach LOS		A			B			D			D	
Intersection Summary												
HCM 2000 Control Delay			25.9				HCM 2000 Level of Service				C	
HCM 2000 Volume to Capacity ratio			0.55									
Actuated Cycle Length (s)			130.0				Sum of lost time (s)				20.0	
Intersection Capacity Utilization			56.4%				ICU Level of Service				B	
Analysis Period (min)			15									
c	Critical Lane Group											

Queues

Existing Traffic

5: Coleraine Drive & Private Access/George Bolton Parkway

AM Peak Hour



Lane Group	EBL	EBT	WBL	WBT	NBL	NBT	SBL	SBT	SBR
Lane Configurations	↶	↷	↶	↷	↶	↷	↶	↷	↷
Traffic Volume (vph)	4	12	63	23	30	278	84	346	11
Future Volume (vph)	4	12	63	23	30	278	84	346	11
Lane Group Flow (vph)	5	29	73	191	35	435	98	402	13
Turn Type	Perm	NA	Perm	NA	Perm	NA	Perm	NA	Perm
Protected Phases		8		4		6		2	
Permitted Phases	8		4		6		2		2
Detector Phase	8	8	4	4	6	6	2	2	2
Switch Phase									
Minimum Initial (s)	8.0	8.0	12.0	12.0	12.0	12.0	12.0	12.0	12.0
Minimum Split (s)	32.5	32.5	32.5	32.5	34.2	34.2	33.7	33.7	33.7
Total Split (s)	45.0	45.0	45.0	45.0	55.0	55.0	55.0	55.0	55.0
Total Split (%)	45.0%	45.0%	45.0%	45.0%	55.0%	55.0%	55.0%	55.0%	55.0%
Yellow Time (s)	4.0	4.0	4.0	4.0	4.2	4.2	4.2	4.2	4.2
All-Red Time (s)	3.5	3.5	3.5	3.5	2.5	2.5	2.5	2.5	2.5
Lost Time Adjust (s)	0.0	0.0	0.0	0.0	0.0	0.0	0.0	0.0	0.0
Total Lost Time (s)	7.5	7.5	7.5	7.5	6.7	6.7	6.7	6.7	6.7
Lead/Lag									
Lead-Lag Optimize?									
Recall Mode	None	None	None	None	C-Max	C-Max	C-Max	C-Max	C-Max
v/c Ratio	0.04	0.15	0.52	0.56	0.07	0.21	0.16	0.18	0.01
Control Delay	35.2	24.0	52.1	15.3	5.5	4.6	6.0	5.3	0.0
Queue Delay	0.0	0.0	0.0	0.0	0.0	0.0	0.0	0.0	0.0
Total Delay	35.2	24.0	52.1	15.3	5.5	4.6	6.0	5.3	0.0
Queue Length 50th (m)	0.9	2.6	14.2	5.0	1.7	10.3	5.2	11.3	0.0
Queue Length 95th (m)	3.9	9.7	25.9	21.4	5.6	18.9	13.2	20.3	0.0
Internal Link Dist (m)		152.4		468.8		784.9		1711.9	
Turn Bay Length (m)	70.0		105.0		75.0		100.0		100.0
Base Capacity (vph)	345	486	369	633	529	2090	596	2178	1001
Starvation Cap Reductn	0	0	0	0	0	0	0	0	0
Spillback Cap Reductn	0	0	0	0	0	0	0	0	0
Storage Cap Reductn	0	0	0	0	0	0	0	0	0
Reduced v/c Ratio	0.01	0.06	0.20	0.30	0.07	0.21	0.16	0.18	0.01

Intersection Summary

Cycle Length: 100

Actuated Cycle Length: 100

Offset: 0 (0%), Referenced to phase 2:SBTL and 6:NBTL, Start of Green

Natural Cycle: 70

Control Type: Actuated-Coordinated

Splits and Phases: 5: Coleraine Drive & Private Access/George Bolton Parkway

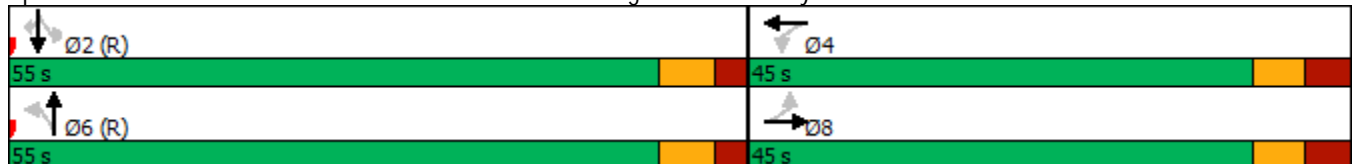

HCM Signalized Intersection Capacity Analysis

5: Coleraine Drive & Private Access/George Bolton Parkway

Existing Traffic
AM Peak Hour



Movement	EBL	EBT	EBR	WBL	WBT	WBR	NBL	NBT	NBR	SBL	SBT	SBR
Lane Configurations	↖	↗		↖	↗		↖	↕		↖	↕	↗
Traffic Volume (vph)	4	12	13	63	23	141	30	278	96	84	346	11
Future Volume (vph)	4	12	13	63	23	141	30	278	96	84	346	11
Ideal Flow (vphpl)	1900	1900	1900	1900	1900	1900	1900	1900	1900	1900	1900	1900
Lane Width	3.0	3.5	3.0	3.0	3.5	3.0	3.0	3.5	3.0	3.0	3.5	3.0
Total Lost time (s)	7.5	7.5		7.5	7.5		6.7	6.7		6.7	6.7	6.7
Lane Util. Factor	1.00	1.00		1.00	1.00		1.00	0.95		1.00	0.95	1.00
Frt	1.00	0.92		1.00	0.87		1.00	0.96		1.00	1.00	0.85
Flt Protected	0.95	1.00		0.95	1.00		0.95	1.00		0.95	1.00	1.00
Satd. Flow (prot)	1685	1271		1267	1417		1370	2902		1589	3051	1383
Flt Permitted	0.52	1.00		0.74	1.00		0.52	1.00		0.50	1.00	1.00
Satd. Flow (perm)	921	1271		984	1417		743	2902		835	3051	1383
Peak-hour factor, PHF	0.86	0.86	0.86	0.86	0.86	0.86	0.86	0.86	0.86	0.86	0.86	0.86
Adj. Flow (vph)	5	14	15	73	27	164	35	323	112	98	402	13
RTOR Reduction (vph)	0	13	0	0	140	0	0	19	0	0	0	4
Lane Group Flow (vph)	5	16	0	73	51	0	35	416	0	98	402	9
Heavy Vehicles (%)	0%	42%	31%	33%	43%	11%	23%	18%	19%	6%	17%	9%
Turn Type	Perm	NA		Perm	NA		Perm	NA		Perm	NA	Perm
Protected Phases		8			4			6			2	
Permitted Phases	8			4			6			2		2
Actuated Green, G (s)	14.4	14.4		14.4	14.4		71.4	71.4		71.4	71.4	71.4
Effective Green, g (s)	14.4	14.4		14.4	14.4		71.4	71.4		71.4	71.4	71.4
Actuated g/C Ratio	0.14	0.14		0.14	0.14		0.71	0.71		0.71	0.71	0.71
Clearance Time (s)	7.5	7.5		7.5	7.5		6.7	6.7		6.7	6.7	6.7
Vehicle Extension (s)	3.0	3.0		3.0	3.0		3.0	3.0		3.0	3.0	3.0
Lane Grp Cap (vph)	132	183		141	204		530	2072		596	2178	987
v/s Ratio Prot		0.01			0.04			c0.14			0.13	
v/s Ratio Perm	0.01			c0.07			0.05			0.12		0.01
v/c Ratio	0.04	0.09		0.52	0.25		0.07	0.20		0.16	0.18	0.01
Uniform Delay, d1	36.8	37.1		39.6	38.0		4.3	4.8		4.6	4.7	4.1
Progression Factor	1.00	1.00		1.00	1.00		1.00	1.00		1.00	1.00	1.00
Incremental Delay, d2	0.1	0.2		3.2	0.6		0.2	0.2		0.6	0.2	0.0
Delay (s)	37.0	37.3		42.8	38.6		4.5	5.0		5.2	4.9	4.1
Level of Service	D	D		D	D		A	A		A	A	A
Approach Delay (s)		37.3			39.8			5.0			4.9	
Approach LOS		D			D			A			A	

Intersection Summary

HCM 2000 Control Delay	13.0	HCM 2000 Level of Service	B
HCM 2000 Volume to Capacity ratio	0.25		
Actuated Cycle Length (s)	100.0	Sum of lost time (s)	14.2
Intersection Capacity Utilization	48.3%	ICU Level of Service	A
Analysis Period (min)	15		

c Critical Lane Group

Queues
6: Highway 50 & George Bolton Parkway/Private Access

Existing Traffic
AM Peak Hour



Lane Group	EBL	EBT	WBT	NBL	NBT	SBL	SBT	SBR
Lane Configurations								
Traffic Volume (vph)	76	0	0	146	844	3	1125	138
Future Volume (vph)	76	0	0	146	844	3	1125	138
Lane Group Flow (vph)	79	108	1	152	879	3	1172	144
Turn Type	Perm	NA	NA	pm+pt	NA	Perm	NA	Perm
Protected Phases		8	4	1	6		2	
Permitted Phases	8			6		2		2
Detector Phase	8	8	4	1	6	2	2	2
Switch Phase								
Minimum Initial (s)	8.0	8.0	8.0	5.0	12.0	12.0	12.0	12.0
Minimum Split (s)	32.6	32.6	32.6	8.0	27.3	27.3	27.3	27.3
Total Split (s)	35.0	35.0	35.0	10.0	85.0	75.0	75.0	75.0
Total Split (%)	29.2%	29.2%	29.2%	8.3%	70.8%	62.5%	62.5%	62.5%
Yellow Time (s)	4.0	4.0	4.0	3.0	4.0	4.0	4.0	4.0
All-Red Time (s)	2.6	2.6	2.6	0.0	2.3	2.3	2.3	2.3
Lost Time Adjust (s)	0.0	0.0	0.0	0.0	0.0	0.0	0.0	0.0
Total Lost Time (s)	6.6	6.6	6.6	3.0	6.3	6.3	6.3	6.3
Lead/Lag				Lead		Lag	Lag	Lag
Lead-Lag Optimize?				Yes		Yes	Yes	Yes
Recall Mode	None	None	None	None	C-Max	C-Max	C-Max	C-Max
v/c Ratio	0.59	0.39	0.00	0.50	0.33	0.01	0.52	0.14
Control Delay	67.3	5.4	0.0	8.7	4.6	8.3	11.3	2.0
Queue Delay	0.0	0.0	0.0	0.0	0.0	0.0	0.0	0.0
Total Delay	67.3	5.4	0.0	8.7	4.6	8.3	11.3	2.0
Queue Length 50th (m)	18.9	0.0	0.0	6.4	27.8	0.2	67.5	0.4
Queue Length 95th (m)	34.2	3.6	0.0	14.6	45.4	1.6	107.8	8.6
Internal Link Dist (m)		846.5	43.0		1045.6		1307.8	
Turn Bay Length (m)	85.0			40.0		135.0		60.0
Base Capacity (vph)	286	401	528	305	2655	390	2250	1030
Starvation Cap Reductn	0	0	0	0	0	0	0	0
Spillback Cap Reductn	0	0	0	0	0	0	0	0
Storage Cap Reductn	0	0	0	0	0	0	0	0
Reduced v/c Ratio	0.28	0.27	0.00	0.50	0.33	0.01	0.52	0.14

Intersection Summary

Cycle Length: 120
 Actuated Cycle Length: 120
 Offset: 113 (94%), Referenced to phase 2:SBTL and 6:NBTL, Start of Green
 Natural Cycle: 80
 Control Type: Actuated-Coordinated



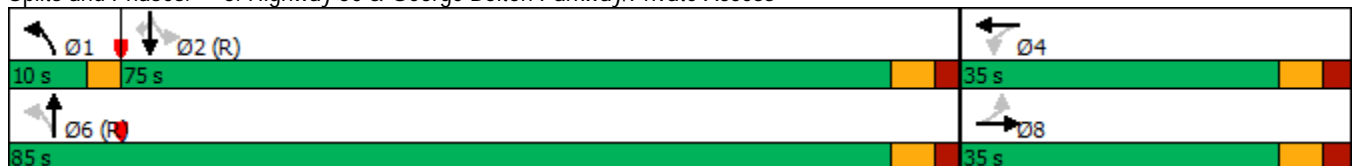

















Splits and Phases: 6: Highway 50 & George Bolton Parkway/Private Access



HCM Signalized Intersection Capacity Analysis

6: Highway 50 & George Bolton Parkway/Private Access

Existing Traffic
AM Peak Hour

													
Movement	EBL	EBT	EBR	WBL	WBT	WBR	NBL	NBT	NBR	SBL	SBT	SBR	
Lane Configurations													
Traffic Volume (vph)	76	0	104	0	0	1	146	844	0	3	1125	138	
Future Volume (vph)	76	0	104	0	0	1	146	844	0	3	1125	138	
Ideal Flow (vphpl)	1900	1900	1900	1900	1900	1900	1900	1900	1900	1900	1900	1900	
Lane Width	3.0	3.5	3.0	3.0	3.5	3.0	3.0	3.5	3.0	3.0	3.5	3.0	
Total Lost time (s)	6.6	6.6			6.6		3.0	6.3		6.3	6.3	6.3	
Lane Util. Factor	1.00	1.00			1.00		1.00	0.95		1.00	0.95	1.00	
Frt	1.00	0.85			0.86		1.00	1.00		1.00	1.00	0.85	
Flt Protected	0.95	1.00			1.00		0.95	1.00		0.95	1.00	1.00	
Satd. Flow (prot)	1518	1166			1625		1359	3400		1685	3305	1449	
Flt Permitted	0.76	1.00			1.00		0.19	1.00		0.32	1.00	1.00	
Satd. Flow (perm)	1210	1166			1625		277	3400		573	3305	1449	
Peak-hour factor, PHF	0.96	0.96	0.96	0.96	0.96	0.96	0.96	0.96	0.96	0.96	0.96	0.96	
Adj. Flow (vph)	79	0	108	0	0	1	152	879	0	3	1172	144	
RTOR Reduction (vph)	0	96	0	0	1	0	0	0	0	0	0	44	
Lane Group Flow (vph)	79	12	0	0	0	0	152	879	0	3	1172	100	
Heavy Vehicles (%)	11%	0%	37%	0%	0%	0%	24%	5%	0%	0%	8%	4%	
Turn Type	Perm	NA			NA		pm+pt	NA		Perm	NA	Perm	
Protected Phases		8			4		1	6			2		
Permitted Phases	8			4			6			2		2	
Actuated Green, G (s)	13.4	13.4			13.4		93.7	93.7		81.7	81.7	81.7	
Effective Green, g (s)	13.4	13.4			13.4		93.7	93.7		81.7	81.7	81.7	
Actuated g/C Ratio	0.11	0.11			0.11		0.78	0.78		0.68	0.68	0.68	
Clearance Time (s)	6.6	6.6			6.6		3.0	6.3		6.3	6.3	6.3	
Vehicle Extension (s)	3.0	3.0			3.0		3.0	3.0		3.0	3.0	3.0	
Lane Grp Cap (vph)	135	130			181		297	2654		390	2250	986	
v/s Ratio Prot		0.01			0.00		c0.04	0.26			0.35		
v/s Ratio Perm	c0.07						c0.36			0.01		0.07	
v/c Ratio	0.59	0.09			0.00		0.51	0.33		0.01	0.52	0.10	
Uniform Delay, d1	50.7	47.8			47.4		5.3	3.9		6.1	9.5	6.6	
Progression Factor	1.00	1.00			1.00		1.00	1.00		1.00	1.00	1.00	
Incremental Delay, d2	6.3	0.3			0.0		1.5	0.3		0.0	0.9	0.2	
Delay (s)	57.0	48.2			47.4		6.8	4.2		6.2	10.3	6.8	
Level of Service	E	D			D		A	A		A	B	A	
Approach Delay (s)		51.9			47.4			4.6			9.9		
Approach LOS		D			D			A			A		

Intersection Summary

HCM 2000 Control Delay	10.9	HCM 2000 Level of Service	B
HCM 2000 Volume to Capacity ratio	0.53		
Actuated Cycle Length (s)	120.0	Sum of lost time (s)	15.9
Intersection Capacity Utilization	64.1%	ICU Level of Service	C
Analysis Period (min)	15		

c Critical Lane Group

Queues
1: Coleraine Drive & Healey Road

Existing Traffic
PM Peak



Lane Group	EBL	EBT	WBL	WBT	NBL	NBT	SBL	SBT
Lane Configurations	↖	↗	↖	↗	↖	↗	↖	↗
Traffic Volume (vph)	101	148	43	256	254	309	47	157
Future Volume (vph)	101	148	43	256	254	309	47	157
Lane Group Flow (vph)	111	299	47	374	279	384	52	249
Turn Type	Perm	NA	Perm	NA	Perm	NA	Perm	NA
Protected Phases		8		4		6		2
Permitted Phases	8		4		6		2	
Detector Phase	8	8	4	4	6	6	2	2
Switch Phase								
Minimum Initial (s)	8.0	8.0	8.0	8.0	8.0	8.0	8.0	8.0
Minimum Split (s)	32.8	32.8	32.8	32.8	36.7	36.7	36.7	36.7
Total Split (s)	33.0	33.0	33.0	33.0	37.0	37.0	37.0	37.0
Total Split (%)	47.1%	47.1%	47.1%	47.1%	52.9%	52.9%	52.9%	52.9%
Yellow Time (s)	4.0	4.0	4.0	4.0	4.6	4.6	4.6	4.6
All-Red Time (s)	2.8	2.8	2.8	2.8	2.1	2.1	2.1	2.1
Lost Time Adjust (s)	0.0	0.0	0.0	0.0	0.0	0.0	0.0	0.0
Total Lost Time (s)	6.8	6.8	6.8	6.8	6.7	6.7	6.7	6.7
Lead/Lag								
Lead-Lag Optimize?								
Recall Mode	None	None	None	None	C-Max	C-Max	C-Max	C-Max
v/c Ratio	0.65	0.56	0.22	0.75	0.50	0.24	0.13	0.16
Control Delay	39.1	19.8	19.9	30.6	16.1	9.8	11.4	7.2
Queue Delay	0.0	0.0	0.0	0.0	0.0	0.0	0.0	0.0
Total Delay	39.1	19.8	19.9	30.6	16.1	9.8	11.4	7.2
Queue Length 50th (m)	13.4	26.4	5.0	43.3	22.8	12.8	3.3	5.8
Queue Length 95th (m)	27.2	42.6	11.4	62.7	53.4	25.2	10.9	13.8
Internal Link Dist (m)		1349.5		424.0		1711.9		1121.0
Turn Bay Length (m)	55.0		50.0		80.0		155.0	
Base Capacity (vph)	232	695	297	668	562	1592	415	1547
Starvation Cap Reductn	0	0	0	0	0	0	0	0
Spillback Cap Reductn	0	0	0	0	0	0	0	0
Storage Cap Reductn	0	0	0	0	0	0	0	0
Reduced v/c Ratio	0.48	0.43	0.16	0.56	0.50	0.24	0.13	0.16

Intersection Summary

Cycle Length: 70
 Actuated Cycle Length: 70
 Offset: 12 (17%), Referenced to phase 2:SBTL and 6:NBTL, Start of Green
 Natural Cycle: 70
 Control Type: Actuated-Coordinated



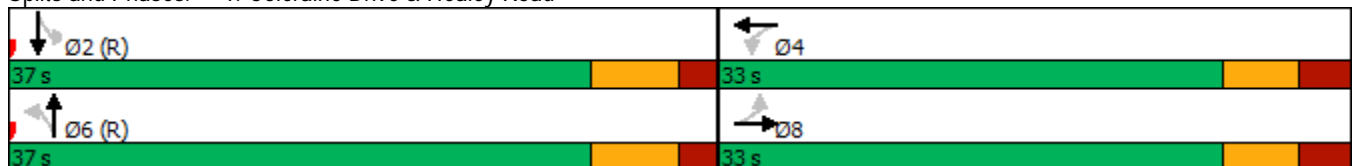



















Splits and Phases: 1: Coleraine Drive & Healey Road



HCM Signalized Intersection Capacity Analysis

1: Coleraine Drive & Healey Road

Existing Traffic
PM Peak

















												
Movement	EBL	EBT	EBR	WBL	WBT	WBR	NBL	NBT	NBR	SBL	SBT	SBR
Lane Configurations												
Traffic Volume (vph)	101	148	124	43	256	85	254	309	40	47	157	69
Future Volume (vph)	101	148	124	43	256	85	254	309	40	47	157	69
Ideal Flow (vphpl)	1900	1900	1900	1900	1900	1900	1900	1900	1900	1900	1900	1900
Lane Width	3.0	3.5	3.0	3.0	3.5	3.0	3.0	3.5	3.0	3.0	3.5	3.0
Total Lost time (s)	6.8	6.8		6.8	6.8		6.7	6.7		6.7	6.7	
Lane Util. Factor	1.00	1.00		1.00	1.00		1.00	0.95		1.00	0.95	
Flt	1.00	0.93		1.00	0.96		1.00	0.98		1.00	0.95	
Flt Protected	0.95	1.00		0.95	1.00		0.95	1.00		0.95	1.00	
Satd. Flow (prot)	1652	1741		1574	1740		1685	2973		1416	2844	
Flt Permitted	0.36	1.00		0.48	1.00		0.60	1.00		0.52	1.00	
Satd. Flow (perm)	622	1741		794	1740		1059	2973		782	2844	
Peak-hour factor, PHF	0.91	0.91	0.91	0.91	0.91	0.91	0.91	0.91	0.91	0.91	0.91	0.91
Adj. Flow (vph)	111	163	136	47	281	93	279	340	44	52	173	76
RTOR Reduction (vph)	0	50	0	0	20	0	0	12	0	0	36	0
Lane Group Flow (vph)	111	249	0	47	354	0	279	372	0	52	213	0
Heavy Vehicles (%)	2%	1%	0%	7%	0%	16%	0%	18%	18%	19%	28%	1%
Turn Type	Perm	NA		Perm	NA		Perm	NA		Perm	NA	
Protected Phases		8			4			6			2	
Permitted Phases	8			4			6			2		
Actuated Green, G (s)	19.3	19.3		19.3	19.3		37.2	37.2		37.2	37.2	
Effective Green, g (s)	19.3	19.3		19.3	19.3		37.2	37.2		37.2	37.2	
Actuated g/C Ratio	0.28	0.28		0.28	0.28		0.53	0.53		0.53	0.53	
Clearance Time (s)	6.8	6.8		6.8	6.8		6.7	6.7		6.7	6.7	
Vehicle Extension (s)	3.0	3.0		3.0	3.0		3.0	3.0		3.0	3.0	
Lane Grp Cap (vph)	171	480		218	479		562	1579		415	1511	
v/s Ratio Prot		0.14			c0.20			0.13			0.08	
v/s Ratio Perm	0.18			0.06			c0.26			0.07		
v/c Ratio	0.65	0.52		0.22	0.74		0.50	0.24		0.13	0.14	
Uniform Delay, d1	22.4	21.4		19.5	23.1		10.4	8.8		8.2	8.3	
Progression Factor	1.00	1.00		1.00	1.00		1.00	1.00		1.00	1.00	
Incremental Delay, d2	8.2	0.9		0.5	5.9		3.1	0.4		0.6	0.2	
Delay (s)	30.6	22.4		20.0	29.0		13.6	9.1		8.9	8.5	
Level of Service	C	C		C	C		B	A		A	A	
Approach Delay (s)		24.6			28.0			11.0			8.6	
Approach LOS		C			C			B			A	
Intersection Summary												
HCM 2000 Control Delay			17.7				HCM 2000 Level of Service				B	
HCM 2000 Volume to Capacity ratio			0.58									
Actuated Cycle Length (s)			70.0				Sum of lost time (s)			13.5		
Intersection Capacity Utilization			68.5%				ICU Level of Service			C		
Analysis Period (min)			15									

c Critical Lane Group

HCM Unsignalized Intersection Capacity Analysis

2: Humber Station Road & Healey Road

Existing Traffic
PM Peak

												
Movement	EBL	EBT	EBR	WBL	WBT	WBR	NBL	NBT	NBR	SBL	SBT	SBR
Lane Configurations												
Sign Control		Stop			Stop			Stop			Stop	
Traffic Volume (vph)	21	247	6	34	496	22	16	187	65	22	42	6
Future Volume (vph)	21	247	6	34	496	22	16	187	65	22	42	6
Peak Hour Factor	0.97	0.97	0.97	0.97	0.97	0.97	0.97	0.97	0.97	0.97	0.97	0.97
Hourly flow rate (vph)	22	255	6	35	511	23	16	193	67	23	43	6
Direction, Lane #	EB 1	WB 1	NB 1	SB 1								
Volume Total (vph)	283	569	276	72								
Volume Left (vph)	22	35	16	23								
Volume Right (vph)	6	23	67	6								
Hadj (s)	0.02	-0.01	-0.10	0.03								
Departure Headway (s)	6.1	5.6	6.4	7.2								
Degree Utilization, x	0.48	0.89	0.49	0.14								
Capacity (veh/h)	553	629	526	445								
Control Delay (s)	14.8	37.7	15.5	11.4								
Approach Delay (s)	14.8	37.7	15.5	11.4								
Approach LOS	B	E	C	B								
Intersection Summary												
Delay			25.6									
Level of Service			D									
Intersection Capacity Utilization			58.2%	ICU Level of Service								B
Analysis Period (min)			15									

Queues

Existing Traffic

3: Clarkway Drive/Humber Station Road & Mayfield Road

PM Peak



Lane Group	EBL	EBT	WBL	WBT	NBT	SBT
Lane Configurations		↕		↕	↕	↕
Traffic Volume (vph)	10	527	52	645	245	62
Future Volume (vph)	10	527	52	645	245	62
Lane Group Flow (vph)	0	573	0	723	426	76
Turn Type	Perm	NA	Perm	NA	NA	NA
Protected Phases		2		6	4	3
Permitted Phases	2		6			
Detector Phase	2	2	6	6	4	3
Switch Phase						
Minimum Initial (s)	12.0	12.0	12.0	12.0	8.0	8.0
Minimum Split (s)	27.3	27.3	27.3	27.3	26.0	26.0
Total Split (s)	55.0	55.0	55.0	55.0	45.0	20.0
Total Split (%)	45.8%	45.8%	45.8%	45.8%	37.5%	16.7%
Yellow Time (s)	4.6	4.6	4.6	4.6	4.2	4.2
All-Red Time (s)	2.7	2.7	2.7	2.7	2.8	2.8
Lost Time Adjust (s)		0.0		0.0	0.0	0.0
Total Lost Time (s)		7.3		7.3	7.0	7.0
Lead/Lag					Lag	Lead
Lead-Lag Optimize?					Yes	Yes
Recall Mode	C-Max	C-Max	C-Max	C-Max	None	None
v/c Ratio		0.73		0.97	0.88	0.48
Control Delay		34.6		59.8	60.8	62.3
Queue Delay		0.0		0.0	0.0	0.0
Total Delay		34.6		59.8	60.8	62.3
Queue Length 50th (m)		118.3		~194.8	99.4	18.3
Queue Length 95th (m)		#199.1		#289.7	136.1	34.1
Internal Link Dist (m)		912.9		1363.4	257.8	3037.3
Turn Bay Length (m)						
Base Capacity (vph)		786		745	553	195
Starvation Cap Reductn		0		0	0	0
Spillback Cap Reductn		0		0	0	0
Storage Cap Reductn		0		0	0	0
Reduced v/c Ratio		0.73		0.97	0.77	0.39

Intersection Summary

Cycle Length: 120
 Actuated Cycle Length: 120
 Offset: 43 (36%), Referenced to phase 2:EBTL and 6:WBTL, Start of Green
 Natural Cycle: 140
 Control Type: Actuated-Coordinated
 ~ Volume exceeds capacity, queue is theoretically infinite.
 Queue shown is maximum after two cycles.
 # 95th percentile volume exceeds capacity, queue may be longer.
 Queue shown is maximum after two cycles.

Splits and Phases: 3: Clarkway Drive/Humber Station Road & Mayfield Road

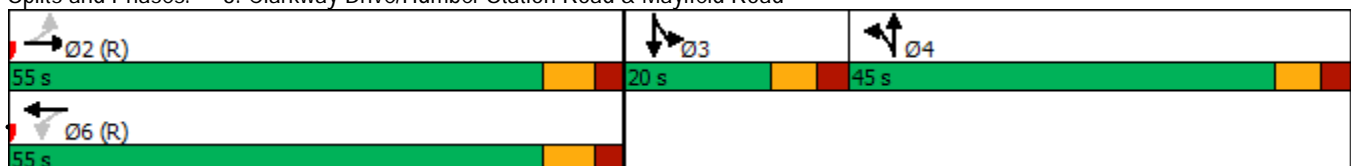

HCM Signalized Intersection Capacity Analysis
 3: Clarkway Drive/Humber Station Road & Mayfield Road

Existing Traffic
 PM Peak



Movement	EBL	EBT	EBR	WBL	WBT	WBR	NBL	NBT	NBR	SBL	SBT	SBR	
Lane Configurations		↕			↕			↕			↕		
Traffic Volume (vph)	10	527	19	52	645	4	59	245	109	0	62	12	
Future Volume (vph)	10	527	19	52	645	4	59	245	109	0	62	12	
Ideal Flow (vphpl)	1900	1900	1900	1900	1900	1900	1900	1900	1900	1900	1900	1900	
Lane Width	3.0	3.5	3.0	3.0	3.5	3.0	3.0	3.5	3.0	3.0	3.5	3.0	
Total Lost time (s)		7.3			7.3			7.0			7.0		
Lane Util. Factor		1.00			1.00			1.00			1.00		
Frt		1.00			1.00			0.96			0.98		
Flt Protected		1.00			1.00			0.99			1.00		
Satd. Flow (prot)		1653			1696			1744			1808		
Flt Permitted		0.98			0.91			0.99			1.00		
Satd. Flow (perm)		1629			1545			1744			1808		
Peak-hour factor, PHF	0.97	0.97	0.97	0.97	0.97	0.97	0.97	0.97	0.97	0.97	0.97	0.97	
Adj. Flow (vph)	10	543	20	54	665	4	61	253	112	0	64	12	
RTOR Reduction (vph)	0	1	0	0	0	0	0	0	0	0	0	0	
Lane Group Flow (vph)	0	572	0	0	723	0	0	426	0	0	76	0	
Heavy Vehicles (%)	20%	13%	11%	2%	11%	0%	12%	2%	1%	0%	2%	0%	
Turn Type	Perm	NA		Perm	NA		Split		NA		NA		
Protected Phases		2			6		4		4		3		
Permitted Phases	2		6										
Actuated Green, G (s)		56.5			56.5			33.4			8.8		
Effective Green, g (s)		56.5			56.5			33.4			8.8		
Actuated g/C Ratio		0.47			0.47			0.28			0.07		
Clearance Time (s)		7.3			7.3			7.0			7.0		
Vehicle Extension (s)		3.0			3.0			3.0			3.0		
Lane Grp Cap (vph)		766			727			485			132		
v/s Ratio Prot								c0.24			c0.04		
v/s Ratio Perm		0.35			c0.47								
v/c Ratio		0.75			0.99			0.88			0.58		
Uniform Delay, d1		25.9			31.6			41.4			53.8		
Progression Factor		1.00			1.00			1.00			1.00		
Incremental Delay, d2		6.5			32.1			16.3			6.0		
Delay (s)		32.5			63.7			57.7			59.8		
Level of Service		C			E			E			E		
Approach Delay (s)		32.5			63.7			57.7			59.8		
Approach LOS		C			E			E			E		
Intersection Summary													
HCM 2000 Control Delay		52.1			HCM 2000 Level of Service			D					
HCM 2000 Volume to Capacity ratio		0.92											
Actuated Cycle Length (s)		120.0			Sum of lost time (s)			21.3					
Intersection Capacity Utilization		104.2%			ICU Level of Service			G					
Analysis Period (min)		15											

c Critical Lane Group

Queues
4: Coleraine Drive & Mayfield Road

Existing Traffic
PM Peak

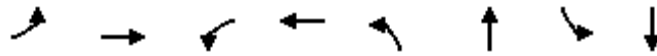

Lane Group	EBL	EBT	WBL	WBT	NBL	NBT	SBL	SBT
Lane Configurations	↶	↶↷	↶	↶↷	↶	↶↷	↶	↶↷
Traffic Volume (vph)	168	458	13	458	52	277	25	201
Future Volume (vph)	168	458	13	458	52	277	25	201
Lane Group Flow (vph)	177	513	14	522	55	314	26	443
Turn Type	pm+pt	NA	Perm	NA	Perm	NA	pm+pt	NA
Protected Phases	5	2		6		4	3	8
Permitted Phases	2		6		4		8	
Detector Phase	5	2	6	6	4	4	3	8
Switch Phase								
Minimum Initial (s)	5.0	12.0	12.0	12.0	12.0	12.0	5.0	12.0
Minimum Split (s)	8.0	37.0	37.0	37.0	37.0	37.0	9.5	37.0
Total Split (s)	12.0	80.0	68.0	68.0	36.0	36.0	14.0	50.0
Total Split (%)	9.2%	61.5%	52.3%	52.3%	27.7%	27.7%	10.8%	38.5%
Yellow Time (s)	3.0	4.6	4.6	4.6	4.2	4.2	3.0	4.2
All-Red Time (s)	0.0	2.4	2.4	2.4	2.8	2.8	0.0	2.8
Lost Time Adjust (s)	0.0	0.0	0.0	0.0	0.0	0.0	0.0	0.0
Total Lost Time (s)	3.0	7.0	7.0	7.0	7.0	7.0	3.0	7.0
Lead/Lag	Lead		Lag	Lag	Lag	Lag	Lead	
Lead-Lag Optimize?	Yes		Yes	Yes	Yes	Yes	Yes	
Recall Mode	None	C-Max	C-Max	C-Max	None	None	None	None
v/c Ratio	0.33	0.21	0.03	0.27	0.50	0.69	0.18	0.59
Control Delay	8.1	7.6	15.5	14.4	67.7	61.0	39.5	24.9
Queue Delay	0.0	0.0	0.0	0.0	0.0	0.0	0.0	0.0
Total Delay	8.1	7.6	15.5	14.4	67.7	61.0	39.5	24.9
Queue Length 50th (m)	14.1	24.4	1.6	35.1	14.0	42.5	5.5	26.5
Queue Length 95th (m)	27.6	38.4	5.9	57.2	28.0	56.6	12.7	41.0
Internal Link Dist (m)		1363.4		205.9		192.7		576.8
Turn Bay Length (m)	100.0		85.0		105.0		145.0	
Base Capacity (vph)	535	2398	457	1939	192	791	163	1177
Starvation Cap Reductn	0	0	0	0	0	0	0	0
Spillback Cap Reductn	0	0	0	0	0	0	0	0
Storage Cap Reductn	0	0	0	0	0	0	0	0
Reduced v/c Ratio	0.33	0.21	0.03	0.27	0.29	0.40	0.16	0.38

Intersection Summary

Cycle Length: 130
 Actuated Cycle Length: 130
 Offset: 116 (89%), Referenced to phase 2:EBTL and 6:WBTL, Start of Green
 Natural Cycle: 95
 Control Type: Actuated-Coordinated

























Splits and Phases: 4: Coleraine Drive & Mayfield Road



HCM Signalized Intersection Capacity Analysis

4: Coleraine Drive & Mayfield Road

Existing Traffic
PM Peak

												
Movement	EBL	EBT	EBR	WBL	WBT	WBR	NBL	NBT	NBR	SBL	SBT	SBR
Lane Configurations		 			 			 			 	
Traffic Volume (vph)	168	458	29	13	458	38	52	277	21	25	201	219
Future Volume (vph)	168	458	29	13	458	38	52	277	21	25	201	219
Ideal Flow (vphpl)	1900	1900	1900	1900	1900	1900	1900	1900	1900	1900	1900	1900
Lane Width	3.0	3.5	3.0	3.0	3.5	3.0	3.0	3.5	3.0	3.0	3.5	3.0
Total Lost time (s)	3.0	7.0		7.0	7.0		7.0	7.0		3.0	7.0	
Lane Util. Factor	1.00	0.95		1.00	0.95		1.00	0.95		1.00	0.95	
Flt	1.00	0.99		1.00	0.99		1.00	0.99		1.00	0.92	
Flt Protected	0.95	1.00		0.95	1.00		0.95	1.00		0.95	1.00	
Satd. Flow (prot)	1404	3379		1560	3213		1685	3532		1239	3097	
Flt Permitted	0.43	1.00		0.46	1.00		0.49	1.00		0.35	1.00	
Satd. Flow (perm)	631	3379		760	3213		861	3532		455	3097	
Peak-hour factor, PHF	0.95	0.95	0.95	0.95	0.95	0.95	0.95	0.95	0.95	0.95	0.95	0.95
Adj. Flow (vph)	177	482	31	14	482	40	55	292	22	26	212	231
RTOR Reduction (vph)	0	2	0	0	4	0	0	4	0	0	184	0
Lane Group Flow (vph)	177	511	0	14	518	0	55	310	0	26	259	0
Heavy Vehicles (%)	20%	5%	0%	8%	8%	32%	0%	0%	0%	36%	0%	12%
Turn Type	pm+pt	NA		Perm	NA		Perm	NA		pm+pt	NA	
Protected Phases	5	2			6			4		3	8	
Permitted Phases	2			6			4			8		
Actuated Green, G (s)	91.0	91.0		77.1	77.1		16.7	16.7		25.0	25.0	
Effective Green, g (s)	91.0	91.0		77.1	77.1		16.7	16.7		25.0	25.0	
Actuated g/C Ratio	0.70	0.70		0.59	0.59		0.13	0.13		0.19	0.19	
Clearance Time (s)	3.0	7.0		7.0	7.0		7.0	7.0		3.0	7.0	
Vehicle Extension (s)	3.0	3.0		3.0	3.0		3.0	3.0		3.0	3.0	
Lane Grp Cap (vph)	506	2365		450	1905		110	453		119	595	
v/s Ratio Prot	c0.03	0.15			0.16			c0.09		0.01	c0.08	
v/s Ratio Perm	c0.22			0.02			0.06			0.03		
v/c Ratio	0.35	0.22		0.03	0.27		0.50	0.68		0.22	0.44	
Uniform Delay, d1	6.9	6.9		11.0	12.8		52.8	54.1		43.5	46.3	
Progression Factor	1.00	1.00		1.00	1.00		1.00	1.00		1.00	1.00	
Incremental Delay, d2	0.4	0.2		0.1	0.4		3.5	4.2		0.9	0.5	
Delay (s)	7.3	7.1		11.1	13.2		56.3	58.4		44.5	46.8	
Level of Service	A	A		B	B		E	E		D	D	
Approach Delay (s)		7.1			13.1			58.1			46.7	
Approach LOS		A			B			E			D	
Intersection Summary												
HCM 2000 Control Delay			26.8	HCM 2000 Level of Service				C				
HCM 2000 Volume to Capacity ratio			0.41									
Actuated Cycle Length (s)			130.0	Sum of lost time (s)				20.0				
Intersection Capacity Utilization			69.5%	ICU Level of Service				C				
Analysis Period (min)			15									

c Critical Lane Group

Queues

Existing Traffic

5: Coleraine Drive & Private Access/George Bolton Parkway

PM Peak



Lane Group	EBL	EBT	WBL	WBT	NBL	NBT	SBL	SBT	SBR
Lane Configurations	↖	↗	↖	↗	↖	↕	↖	↕	↗
Traffic Volume (vph)	7	26	61	9	6	422	145	431	1
Future Volume (vph)	7	26	61	9	6	422	145	431	1
Lane Group Flow (vph)	8	58	73	198	7	592	175	519	1
Turn Type	Perm	NA	Perm	NA	Perm	NA	Perm	NA	Perm
Protected Phases		8		4		6		2	
Permitted Phases	8		4		6		2		2
Detector Phase	8	8	4	4	6	6	2	2	2
Switch Phase									
Minimum Initial (s)	8.0	8.0	12.0	12.0	12.0	12.0	12.0	12.0	12.0
Minimum Split (s)	32.5	32.5	32.5	32.5	34.2	34.2	33.7	33.7	33.7
Total Split (s)	45.0	45.0	45.0	45.0	55.0	55.0	55.0	55.0	55.0
Total Split (%)	45.0%	45.0%	45.0%	45.0%	55.0%	55.0%	55.0%	55.0%	55.0%
Yellow Time (s)	4.0	4.0	4.0	4.0	4.2	4.2	4.2	4.2	4.2
All-Red Time (s)	3.5	3.5	3.5	3.5	2.5	2.5	2.5	2.5	2.5
Lost Time Adjust (s)	0.0	0.0	0.0	0.0	0.0	0.0	0.0	0.0	0.0
Total Lost Time (s)	7.5	7.5	7.5	7.5	6.7	6.7	6.7	6.7	6.7
Lead/Lag									
Lead-Lag Optimize?									
Recall Mode	None	None	None	None	C-Max	C-Max	C-Max	C-Max	C-Max
v/c Ratio	0.07	0.24	0.48	0.54	0.02	0.27	0.34	0.23	0.00
Control Delay	37.4	25.7	50.0	12.8	4.8	5.1	7.7	5.1	0.0
Queue Delay	0.0	0.0	0.0	0.0	0.0	0.0	0.0	0.0	0.0
Total Delay	37.4	25.7	50.0	12.8	4.8	5.1	7.7	5.1	0.0
Queue Length 50th (m)	1.5	5.8	14.2	2.0	0.3	16.3	10.4	14.6	0.0
Queue Length 95th (m)	5.3	14.8	24.9	16.8	1.7	25.8	22.7	23.3	0.0
Internal Link Dist (m)		152.4		468.8		784.9		1711.9	
Turn Bay Length (m)	70.0		105.0		75.0		100.0		100.0
Base Capacity (vph)	322	619	423	675	392	2220	521	2300	1101
Starvation Cap Reductn	0	0	0	0	0	0	0	0	0
Spillback Cap Reductn	0	0	0	0	0	0	0	0	0
Storage Cap Reductn	0	0	0	0	0	0	0	0	0
Reduced v/c Ratio	0.02	0.09	0.17	0.29	0.02	0.27	0.34	0.23	0.00

Intersection Summary

Cycle Length: 100

Actuated Cycle Length: 100

Offset: 0 (0%), Referenced to phase 2:SBTL and 6:NBTL, Start of Green

Natural Cycle: 70

Control Type: Actuated-Coordinated

Splits and Phases: 5: Coleraine Drive & Private Access/George Bolton Parkway

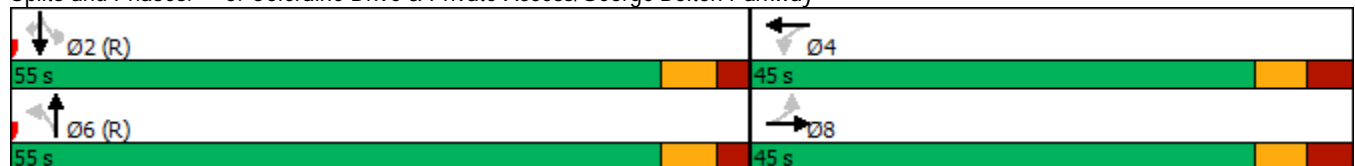

HCM Signalized Intersection Capacity Analysis

5: Coleraine Drive & Private Access/George Bolton Parkway

Existing Traffic
PM Peak



Movement	EBL	EBT	EBR	WBL	WBT	WBR	NBL	NBT	NBR	SBL	SBT	SBR
Lane Configurations	↖	↗		↖	↗		↖	↑↗		↖	↑↑	↗
Traffic Volume (vph)	7	26	22	61	9	155	6	422	70	145	431	1
Future Volume (vph)	7	26	22	61	9	155	6	422	70	145	431	1
Ideal Flow (vphpl)	1900	1900	1900	1900	1900	1900	1900	1900	1900	1900	1900	1900
Lane Width	3.0	3.5	3.0	3.0	3.5	3.0	3.0	3.5	3.0	3.0	3.5	3.0
Total Lost time (s)	7.5	7.5		7.5	7.5		6.7	6.7		6.7	6.7	6.7
Lane Util. Factor	1.00	1.00		1.00	1.00		1.00	0.95		1.00	0.95	1.00
Fr _t	1.00	0.93		1.00	0.86		1.00	0.98		1.00	1.00	0.85
Fl _t Protected	0.95	1.00		0.95	1.00		0.95	1.00		0.95	1.00	1.00
Satd. Flow (prot)	1685	1608		1491	1491		1123	3065		1604	3187	1507
Fl _t Permitted	0.49	1.00		0.72	1.00		0.46	1.00		0.43	1.00	1.00
Satd. Flow (perm)	861	1608		1129	1491		544	3065		724	3187	1507
Peak-hour factor, PHF	0.83	0.83	0.83	0.83	0.83	0.83	0.83	0.83	0.83	0.83	0.83	0.83
Adj. Flow (vph)	8	31	27	73	11	187	7	508	84	175	519	1
RTOR Reduction (vph)	0	23	0	0	162	0	0	7	0	0	0	0
Lane Group Flow (vph)	8	35	0	73	36	0	7	585	0	175	519	1
Heavy Vehicles (%)	0%	4%	14%	13%	11%	8%	50%	14%	14%	5%	12%	0%
Turn Type	Perm	NA		Perm	NA		Perm	NA		Perm	NA	Perm
Protected Phases		8			4			6			2	
Permitted Phases	8			4			6			2		2
Actuated Green, G (s)	13.6	13.6		13.6	13.6		72.2	72.2		72.2	72.2	72.2
Effective Green, g (s)	13.6	13.6		13.6	13.6		72.2	72.2		72.2	72.2	72.2
Actuated g/C Ratio	0.14	0.14		0.14	0.14		0.72	0.72		0.72	0.72	0.72
Clearance Time (s)	7.5	7.5		7.5	7.5		6.7	6.7		6.7	6.7	6.7
Vehicle Extension (s)	3.0	3.0		3.0	3.0		3.0	3.0		3.0	3.0	3.0
Lane Grp Cap (vph)	117	218		153	202		392	2212		522	2301	1088
v/s Ratio Prot		0.02			0.02			0.19			0.16	
v/s Ratio Perm	0.01			c0.06			0.01			c0.24		0.00
v/c Ratio	0.07	0.16		0.48	0.18		0.02	0.26		0.34	0.23	0.00
Uniform Delay, d ₁	37.7	38.1		39.9	38.3		3.9	4.8		5.1	4.6	3.9
Progression Factor	1.00	1.00		1.00	1.00		1.00	1.00		1.00	1.00	1.00
Incremental Delay, d ₂	0.2	0.3		2.3	0.4		0.1	0.3		1.7	0.2	0.0
Delay (s)	37.9	38.5		42.3	38.7		4.0	5.1		6.8	4.8	3.9
Level of Service	D	D		D	D		A	A		A	A	A
Approach Delay (s)		38.4			39.7			5.1			5.3	
Approach LOS		D			D			A			A	

Intersection Summary

HCM 2000 Control Delay	12.3	HCM 2000 Level of Service	B
HCM 2000 Volume to Capacity ratio	0.36		
Actuated Cycle Length (s)	100.0	Sum of lost time (s)	14.2
Intersection Capacity Utilization	51.4%	ICU Level of Service	A
Analysis Period (min)	15		

c Critical Lane Group

Queues
6: Highway 50 & George Bolton Parkway/Private Access

Existing Traffic
PM Peak



Lane Group	EBL	EBT	WBT	NBL	NBT	SBL	SBT	SBR
Lane Configurations								
Traffic Volume (vph)	209	0	0	129	1257	1	873	169
Future Volume (vph)	209	0	0	129	1257	1	873	169
Lane Group Flow (vph)	218	201	7	134	1309	1	909	176
Turn Type	Perm	NA	NA	pm+pt	NA	Perm	NA	Perm
Protected Phases		8	4	1	6		2	
Permitted Phases	8			6		2		2
Detector Phase	8	8	4	1	6	2	2	2
Switch Phase								
Minimum Initial (s)	8.0	8.0	8.0	5.0	12.0	12.0	12.0	12.0
Minimum Split (s)	32.6	32.6	32.6	8.0	27.3	27.3	27.3	27.3
Total Split (s)	35.0	35.0	35.0	10.0	85.0	75.0	75.0	75.0
Total Split (%)	29.2%	29.2%	29.2%	8.3%	70.8%	62.5%	62.5%	62.5%
Yellow Time (s)	4.0	4.0	4.0	3.0	4.0	4.0	4.0	4.0
All-Red Time (s)	2.6	2.6	2.6	0.0	2.3	2.3	2.3	2.3
Lost Time Adjust (s)	0.0	0.0	0.0	0.0	0.0	0.0	0.0	0.0
Total Lost Time (s)	6.6	6.6	6.6	3.0	6.3	6.3	6.3	6.3
Lead/Lag				Lead		Lag	Lag	Lag
Lead-Lag Optimize?				Yes		Yes	Yes	Yes
Recall Mode	None	None	None	None	C-Max	C-Max	C-Max	C-Max
v/c Ratio	0.83	0.44	0.02	0.40	0.55	0.00	0.43	0.19
Control Delay	70.6	6.7	0.1	9.5	10.8	11.0	14.0	2.2
Queue Delay	0.0	0.0	0.0	0.0	0.0	0.0	0.0	0.0
Total Delay	70.6	6.7	0.1	9.5	10.8	11.0	14.0	2.2
Queue Length 50th (m)	51.6	0.0	0.0	9.4	79.2	0.1	63.3	0.0
Queue Length 95th (m)	#78.9	14.9	0.0	18.0	107.3	0.9	81.2	9.7
Internal Link Dist (m)		846.5	43.0		1045.6		1307.8	
Turn Bay Length (m)	85.0			40.0		135.0		60.0
Base Capacity (vph)	315	501	442	335	2362	207	2105	945
Starvation Cap Reductn	0	0	0	0	0	0	0	0
Spillback Cap Reductn	0	0	0	0	0	0	0	0
Storage Cap Reductn	0	0	0	0	0	0	0	0
Reduced v/c Ratio	0.69	0.40	0.02	0.40	0.55	0.00	0.43	0.19

Intersection Summary

Cycle Length: 120
 Actuated Cycle Length: 120
 Offset: 116 (97%), Referenced to phase 2:SBTL and 6:NBTL, Start of Green
 Natural Cycle: 70
 Control Type: Actuated-Coordinated
 # 95th percentile volume exceeds capacity, queue may be longer.
 Queue shown is maximum after two cycles.

Splits and Phases: 6: Highway 50 & George Bolton Parkway/Private Access

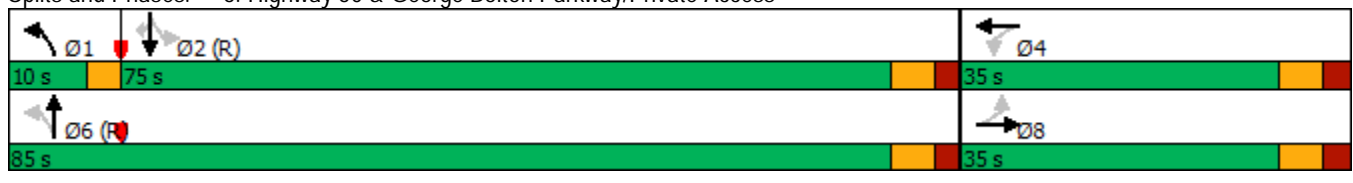

HCM Signalized Intersection Capacity Analysis
6: Highway 50 & George Bolton Parkway/Private Access

Existing Traffic
PM Peak

Movement	EBL	EBT	EBR	WBL	WBT	WBR	NBL	NBT	NBR	SBL	SBT	SBR
Lane Configurations												
Traffic Volume (vph)	209	0	193	0	0	7	129	1257	0	1	873	169
Future Volume (vph)	209	0	193	0	0	7	129	1257	0	1	873	169
Ideal Flow (vphpl)	1900	1900	1900	1900	1900	1900	1900	1900	1900	1900	1900	1900
Lane Width	3.0	3.5	3.0	3.0	3.5	3.0	3.0	3.5	3.0	3.0	3.5	3.0
Total Lost time (s)	6.6	6.6			6.6		3.0	6.3		6.3	6.3	6.3
Lane Util. Factor	1.00	1.00			1.00		1.00	0.95		1.00	0.95	1.00
Frbp, ped/bikes	1.00	0.99			1.00		1.00	1.00		1.00	1.00	0.98
Flpb, ped/bikes	1.00	1.00			1.00		1.00	1.00		1.00	1.00	1.00
Frt	1.00	0.85			0.86		1.00	1.00		1.00	1.00	0.85
Flt Protected	0.95	1.00			1.00		0.95	1.00		0.95	1.00	1.00
Satd. Flow (prot)	1685	1405			1625		1392	3400		1685	3466	1444
Flt Permitted	0.75	1.00			1.00		0.26	1.00		0.19	1.00	1.00
Satd. Flow (perm)	1336	1405			1625		376	3400		343	3466	1444
Peak-hour factor, PHF	0.96	0.96	0.96	0.96	0.96	0.96	0.96	0.96	0.96	0.96	0.96	0.96
Adj. Flow (vph)	218	0	201	0	0	7	134	1309	0	1	909	176
RTOR Reduction (vph)	0	161	0	0	6	0	0	0	0	0	0	69
Lane Group Flow (vph)	218	40	0	0	1	0	134	1309	0	1	909	107
Confl. Peds. (#/hr)			2	2			1					1
Heavy Vehicles (%)	0%	0%	12%	0%	0%	0%	21%	5%	0%	0%	3%	2%
Turn Type	Perm	NA			NA		pm+pt	NA		Perm	NA	Perm
Protected Phases		8			4		1	6			2	
Permitted Phases	8			4			6			2		2
Actuated Green, G (s)	23.7	23.7			23.7		83.4	83.4		72.9	72.9	72.9
Effective Green, g (s)	23.7	23.7			23.7		83.4	83.4		72.9	72.9	72.9
Actuated g/C Ratio	0.20	0.20			0.20		0.70	0.70		0.61	0.61	0.61
Clearance Time (s)	6.6	6.6			6.6		3.0	6.3		6.3	6.3	6.3
Vehicle Extension (s)	3.0	3.0			3.0		3.0	3.0		3.0	3.0	3.0
Lane Grp Cap (vph)	263	277			320		324	2363		208	2105	877
v/s Ratio Prot		0.03			0.00		0.03	c0.39			0.26	
v/s Ratio Perm	c0.16						0.26			0.00		0.07
v/c Ratio	0.83	0.14			0.00		0.41	0.55		0.00	0.43	0.12
Uniform Delay, d1	46.2	39.8			38.7		7.3	9.1		9.3	12.5	10.0
Progression Factor	1.00	1.00			1.00		1.00	1.00		1.00	1.00	1.00
Incremental Delay, d2	18.9	0.2			0.0		0.9	0.9		0.0	0.6	0.3
Delay (s)	65.1	40.0			38.7		8.1	10.0		9.3	13.2	10.3
Level of Service	E	D			D		A	B		A	B	B
Approach Delay (s)		53.1			38.7			9.8			12.7	
Approach LOS		D			D			A			B	
Intersection Summary												
HCM 2000 Control Delay			17.1									B
HCM 2000 Volume to Capacity ratio			0.63									
Actuated Cycle Length (s)			120.0							15.9		
Intersection Capacity Utilization			79.2%									D
Analysis Period (min)			15									
c Critical Lane Group												



APPENDIX I

**Future Background (2028, 2033, 2043)
Intersection Capacity Analysis**

Queues
1: Coleraine Drive & Healey Road

Future Background (2028) - Optimized
AM Peak Hour



Lane Group	EBL	EBT	WBL	WBT	NBL	NBT	SBL	SBT
Lane Configurations	↶	↷	↶	↷	↶	↷	↶	↷
Traffic Volume (vph)	140	343	49	123	35	130	64	324
Future Volume (vph)	140	343	49	123	35	130	64	324
Lane Group Flow (vph)	151	629	53	156	38	169	69	522
Turn Type	Perm	NA	Perm	NA	Perm	NA	Perm	NA
Protected Phases		8		4		6		2
Permitted Phases	8		4		6		2	
Detector Phase	8	8	4	4	6	6	2	2
Switch Phase								
Minimum Initial (s)	8.0	8.0	8.0	8.0	8.0	8.0	8.0	8.0
Minimum Split (s)	32.8	32.8	32.8	32.8	36.7	36.7	36.7	36.7
Total Split (s)	33.0	33.0	33.0	33.0	37.0	37.0	37.0	37.0
Total Split (%)	47.1%	47.1%	47.1%	47.1%	52.9%	52.9%	52.9%	52.9%
Yellow Time (s)	4.0	4.0	4.0	4.0	4.6	4.6	4.6	4.6
All-Red Time (s)	2.8	2.8	2.8	2.8	2.1	2.1	2.1	2.1
Lost Time Adjust (s)	0.0	0.0	0.0	0.0	0.0	0.0	0.0	0.0
Total Lost Time (s)	6.8	6.8	6.8	6.8	6.7	6.7	6.7	6.7
Lead/Lag								
Lead-Lag Optimize?								
Recall Mode	None	None	None	None	C-Max	C-Max	C-Max	C-Max
v/c Ratio	0.37	0.94	0.63	0.26	0.11	0.15	0.17	0.36
Control Delay	19.1	45.1	55.9	15.1	13.0	10.3	13.8	9.9
Queue Delay	0.0	0.0	0.0	0.0	0.0	0.0	0.0	0.0
Total Delay	19.1	45.1	55.9	15.1	13.0	10.3	13.8	9.9
Queue Length 50th (m)	14.7	74.2	5.8	13.0	3.0	5.8	5.6	16.4
Queue Length 95th (m)	29.2	#139.9	#24.0	25.8	8.6	11.4	13.5	27.2
Internal Link Dist (m)		1349.5		424.0		1711.9		1121.0
Turn Bay Length (m)	55.0		50.0		80.0		155.0	
Base Capacity (vph)	424	683	86	622	346	1165	395	1434
Starvation Cap Reductn	0	0	0	0	0	0	0	0
Spillback Cap Reductn	0	0	0	0	0	0	0	0
Storage Cap Reductn	0	0	0	0	0	0	0	0
Reduced v/c Ratio	0.36	0.92	0.62	0.25	0.11	0.15	0.17	0.36

Intersection Summary





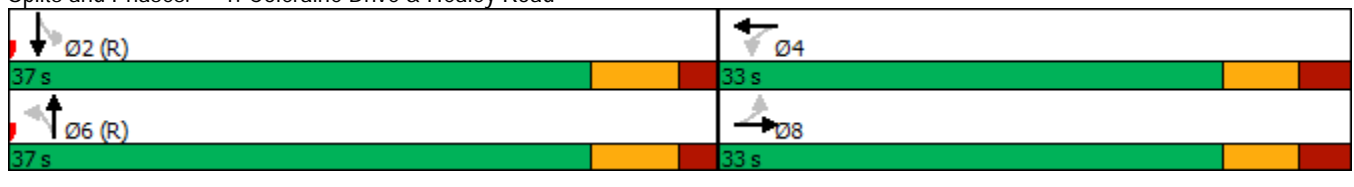

















Cycle Length: 70
 Actuated Cycle Length: 70
 Offset: 6 (9%), Referenced to phase 2:SBTL and 6:NBTL, Start of Green
 Natural Cycle: 70
 Control Type: Actuated-Coordinated
 # 95th percentile volume exceeds capacity, queue may be longer.
 Queue shown is maximum after two cycles.

Splits and Phases: 1: Coleraine Drive & Healey Road



HCM Signalized Intersection Capacity Analysis
1: Coleraine Drive & Healey Road

Future Background (2028) - Optimized
AM Peak Hour

												
Movement	EBL	EBT	EBR	WBL	WBT	WBR	NBL	NBT	NBR	SBL	SBT	SBR
Lane Configurations												
Traffic Volume (vph)	140	343	242	49	123	22	35	130	27	64	324	162
Future Volume (vph)	140	343	242	49	123	22	35	130	27	64	324	162
Ideal Flow (vphpl)	1900	1900	1900	1900	1900	1900	1900	1900	1900	1900	1900	1900
Lane Width	3.0	3.5	3.0	3.0	3.5	3.0	3.0	3.5	3.0	3.0	3.5	3.0
Total Lost time (s)	6.8	6.8		6.8	6.8		6.7	6.7		6.7	6.7	
Lane Util. Factor	1.00	1.00		1.00	1.00		1.00	0.95		1.00	0.95	
Fr't	1.00	0.94		1.00	0.98		1.00	0.97		1.00	0.95	
Fl't Protected	0.95	1.00		0.95	1.00		0.95	1.00		0.95	1.00	
Satd. Flow (prot)	1636	1728		1404	1637		1636	2597		1316	3046	
Fl't Permitted	0.66	1.00		0.16	1.00		0.45	1.00		0.65	1.00	
Satd. Flow (perm)	1133	1728		232	1637		781	2597		894	3046	
Peak-hour factor, PHF	0.93	0.93	0.93	0.93	0.93	0.93	0.93	0.93	0.93	0.93	0.93	0.93
Adj. Flow (vph)	151	369	260	53	132	24	38	140	29	69	348	174
RTOR Reduction (vph)	0	37	0	0	10	0	0	16	0	0	87	0
Lane Group Flow (vph)	151	592	0	53	146	0	38	153	0	69	435	0
Heavy Vehicles (%)	3%	2%	2%	20%	2%	68%	3%	37%	19%	28%	16%	2%
Turn Type	Perm	NA		Perm	NA		Perm	NA		Perm	NA	
Protected Phases		8			4			6			2	
Permitted Phases	8			4			6			2		
Actuated Green, G (s)	25.5	25.5		25.5	25.5		31.0	31.0		31.0	31.0	
Effective Green, g (s)	25.5	25.5		25.5	25.5		31.0	31.0		31.0	31.0	
Actuated g/C Ratio	0.36	0.36		0.36	0.36		0.44	0.44		0.44	0.44	
Clearance Time (s)	6.8	6.8		6.8	6.8		6.7	6.7		6.7	6.7	
Vehicle Extension (s)	3.0	3.0		3.0	3.0		3.0	3.0		3.0	3.0	
Lane Grp Cap (vph)	412	629		84	596		345	1150		395	1348	
v/s Ratio Prot		c0.34			0.09			0.06			c0.14	
v/s Ratio Perm	0.13			0.23			0.05			0.08		
v/c Ratio	0.37	0.94		0.63	0.25		0.11	0.13		0.17	0.32	
Uniform Delay, d1	16.3	21.5		18.4	15.5		11.4	11.5		11.8	12.7	
Progression Factor	1.00	1.00		1.00	1.00		1.00	1.00		1.00	1.00	
Incremental Delay, d2	0.6	22.4		14.4	0.2		0.6	0.2		1.0	0.6	
Delay (s)	16.9	44.0		32.8	15.8		12.1	11.8		12.7	13.3	
Level of Service	B	D		C	B		B	B		B	B	
Approach Delay (s)		38.7			20.1			11.8			13.2	
Approach LOS		D			C			B			B	
Intersection Summary												
HCM 2000 Control Delay			25.0				HCM 2000 Level of Service			C		
HCM 2000 Volume to Capacity ratio			0.60									
Actuated Cycle Length (s)			70.0				Sum of lost time (s)			13.5		
Intersection Capacity Utilization			82.8%				ICU Level of Service			E		
Analysis Period (min)			15									
c Critical Lane Group												

Queues
2: Humber Station Road & Healey Road

Future Background (2028) - Optimized
AM Peak Hour

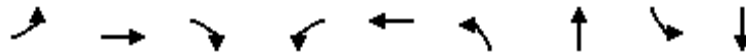

Lane Group	EBL	EBT	EBR	WBL	WBT	NBL	NBT	SBL	SBT
Lane Configurations	↖	↑	↗	↖	↗	↖	↗	↖	↗
Traffic Volume (vph)	4	618	35	73	265	23	18	79	175
Future Volume (vph)	4	618	35	73	265	23	18	79	175
Lane Group Flow (vph)	4	665	38	78	289	25	56	85	192
Turn Type	Perm	NA	Perm	pm+pt	NA	Perm	NA	Perm	NA
Protected Phases		4		3	8		2		6
Permitted Phases	4		4	8		2		6	
Detector Phase	4	4	4	3	8	2	2	6	6
Switch Phase									
Minimum Initial (s)	8.0	8.0	8.0	5.0	8.0	8.0	8.0	5.0	5.0
Minimum Split (s)	24.8	24.8	24.8	9.5	24.8	24.7	24.7	24.8	24.8
Total Split (s)	65.0	65.0	65.0	25.0	90.0	30.0	30.0	30.0	30.0
Total Split (%)	54.2%	54.2%	54.2%	20.8%	75.0%	25.0%	25.0%	25.0%	25.0%
Yellow Time (s)	4.0	4.0	4.0	3.0	4.0	4.6	4.6	4.6	4.6
All-Red Time (s)	2.8	2.8	2.8	0.0	2.8	2.1	2.1	2.1	2.1
Lost Time Adjust (s)	0.0	0.0	0.0	0.0	0.0	0.0	0.0	0.0	0.0
Total Lost Time (s)	6.8	6.8	6.8	3.0	6.8	6.7	6.7	6.7	6.7
Lead/Lag	Lag	Lag	Lag	Lead					
Lead-Lag Optimize?	Yes	Yes	Yes	Yes					
Recall Mode	None	None	None	None	None	C-Max	C-Max	C-Max	C-Max
v/c Ratio	0.01	0.86	0.06	0.36	0.32	0.06	0.08	0.17	0.26
Control Delay	17.0	43.6	1.8	16.3	17.7	23.3	8.8	29.3	29.1
Queue Delay	0.0	0.0	0.0	0.0	0.0	0.0	0.0	0.0	0.0
Total Delay	17.0	43.6	1.8	16.3	17.7	23.3	8.8	29.3	29.1
Queue Length 50th (m)	0.6	144.6	0.0	8.6	38.7	4.6	3.9	14.3	33.4
Queue Length 95th (m)	2.5	176.9	3.0	13.5	48.5	12.4	14.9	29.9	58.5
Internal Link Dist (m)		465.5			1349.5		1464.0		452.2
Turn Bay Length (m)	30.0			60.0		30.0		30.0	
Base Capacity (vph)	401	894	741	381	1271	386	671	499	726
Starvation Cap Reductn	0	0	0	0	0	0	0	0	0
Spillback Cap Reductn	0	0	0	0	0	0	0	0	0
Storage Cap Reductn	0	0	0	0	0	0	0	0	0
Reduced v/c Ratio	0.01	0.74	0.05	0.20	0.23	0.06	0.08	0.17	0.26

Intersection Summary

Cycle Length: 120
 Actuated Cycle Length: 120
 Offset: 0 (0%), Referenced to phase 2:NBTL and 6:SBTL, Start of Green
 Natural Cycle: 70
 Control Type: Actuated-Coordinated

Splits and Phases: 2: Humber Station Road & Healey Road

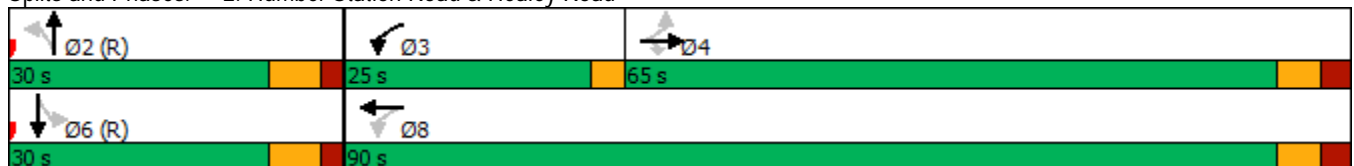

HCM Signalized Intersection Capacity Analysis

2: Humber Station Road & Healey Road

Future Background (2028) - Optimized
AM Peak Hour



Movement	EBL	EBT	EBR	WBL	WBT	WBR	NBL	NBT	NBR	SBL	SBT	SBR
Lane Configurations												
Traffic Volume (vph)	4	618	35	73	265	4	23	18	34	79	175	4
Future Volume (vph)	4	618	35	73	265	4	23	18	34	79	175	4
Ideal Flow (vphpl)	1900	1900	1900	1900	1900	1900	1900	1900	1900	1900	1900	1900
Lane Width	3.0	3.5	3.0	3.0	3.5	3.0	3.0	3.5	3.0	3.0	3.5	3.0
Total Lost time (s)	6.8	6.8	6.8	3.0	6.8		6.7	6.7		6.7	6.7	
Lane Util. Factor	1.00	1.00	1.00	1.00	1.00		1.00	1.00		1.00	1.00	
Fr _t	1.00	1.00	0.85	1.00	1.00		1.00	0.90		1.00	1.00	
Fl _t Protected	0.95	1.00	1.00	0.95	1.00		0.95	1.00		0.95	1.00	
Satd. Flow (prot)	1348	1842	1463	1668	1833		1546	1660		1685	1855	
Fl _t Permitted	0.58	1.00	1.00	0.12	1.00		0.61	1.00		0.72	1.00	
Satd. Flow (perm)	827	1842	1463	219	1833		989	1660		1278	1855	
Peak-hour factor, PHF	0.93	0.93	0.93	0.93	0.93	0.93	0.93	0.93	0.93	0.93	0.93	0.93
Adj. Flow (vph)	4	665	38	78	285	4	25	19	37	85	188	4
RTOR Reduction (vph)	0	0	22	0	0	0	0	23	0	0	1	0
Lane Group Flow (vph)	4	665	16	78	289	0	25	33	0	85	191	0
Heavy Vehicles (%)	25%	2%	3%	1%	2%	25%	9%	0%	3%	0%	1%	0%
Turn Type	Perm	NA	Perm	pm+pt	NA		Perm	NA		Perm	NA	
Protected Phases		4		3	8			2			6	
Permitted Phases	4		4	8			2			6		
Actuated Green, G (s)	50.2	50.2	50.2	60.2	60.2		46.3	46.3		46.3	46.3	
Effective Green, g (s)	50.2	50.2	50.2	60.2	60.2		46.3	46.3		46.3	46.3	
Actuated g/C Ratio	0.42	0.42	0.42	0.50	0.50		0.39	0.39		0.39	0.39	
Clearance Time (s)	6.8	6.8	6.8	3.0	6.8		6.7	6.7		6.7	6.7	
Vehicle Extension (s)	3.0	3.0	3.0	3.0	3.0		3.0	3.0		3.0	3.0	
Lane Grp Cap (vph)	345	770	612	194	919		381	640		493	715	
v/s Ratio Prot		c0.36		c0.02	0.16			0.02			c0.10	
v/s Ratio Perm	0.00		0.01	0.18			0.03			0.07		
v/c Ratio	0.01	0.86	0.03	0.40	0.31		0.07	0.05		0.17	0.27	
Uniform Delay, d ₁	20.4	31.8	20.5	22.1	17.7		23.2	23.1		24.2	25.2	
Progression Factor	1.00	1.00	1.00	1.00	1.00		0.80	0.62		1.00	1.00	
Incremental Delay, d ₂	0.0	9.9	0.0	1.4	0.2		0.3	0.2		0.8	0.9	
Delay (s)	20.4	41.7	20.5	23.4	17.9		18.9	14.5		25.0	26.2	
Level of Service	C	D	C	C	B		B	B		C	C	
Approach Delay (s)		40.4			19.1			15.8			25.8	
Approach LOS		D			B			B			C	

Intersection Summary

HCM 2000 Control Delay	30.7	HCM 2000 Level of Service	C
HCM 2000 Volume to Capacity ratio	0.57		
Actuated Cycle Length (s)	120.0	Sum of lost time (s)	16.5
Intersection Capacity Utilization	70.4%	ICU Level of Service	C
Analysis Period (min)	15		

c Critical Lane Group

Queues

Future Background (2028) - Optimized

3: Clarkway Drive/Humber Station Road & Mayfield Road

AM Peak Hour

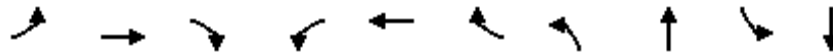

Lane Group	EBL	EBT	EBR	WBL	WBT	WBR	NBL	NBT	SBL	SBT
Lane Configurations	↔	↑↑↑	↔	↔	↑↑	↔	↔	↔	↔	↔
Traffic Volume (vph)	8	754	28	102	567	21	11	52	23	259
Future Volume (vph)	8	754	28	102	567	21	11	52	23	259
Lane Group Flow (vph)	8	785	29	106	591	22	11	260	24	278
Turn Type	Perm	NA	Perm	Perm	NA	Perm	Perm	NA	Perm	NA
Protected Phases		2			6			4		8
Permitted Phases	2		2	6		6	4		8	
Detector Phase	2	2	2	6	6	6	4	4	8	8
Switch Phase										
Minimum Initial (s)	12.0	12.0	12.0	12.0	12.0	12.0	8.0	8.0	8.0	8.0
Minimum Split (s)	27.3	27.3	27.3	27.5	27.5	27.5	26.0	26.0	27.5	27.5
Total Split (s)	70.0	70.0	70.0	70.0	70.0	70.0	50.0	50.0	50.0	50.0
Total Split (%)	58.3%	58.3%	58.3%	58.3%	58.3%	58.3%	41.7%	41.7%	41.7%	41.7%
Yellow Time (s)	4.6	4.6	4.6	4.6	4.6	4.6	4.2	4.2	4.2	4.2
All-Red Time (s)	2.7	2.7	2.7	2.7	2.7	2.7	2.8	2.8	2.8	2.8
Lost Time Adjust (s)	0.0	0.0	0.0	0.0	0.0	0.0	0.0	0.0	0.0	0.0
Total Lost Time (s)	7.3	7.3	7.3	7.3	7.3	7.3	7.0	7.0	7.0	7.0
Lead/Lag										
Lead-Lag Optimize?										
Recall Mode	C-Max	C-Max	C-Max	C-Max	C-Max	C-Max	None	None	None	None
v/c Ratio	0.02	0.26	0.03	0.27	0.29	0.02	0.12	0.60	0.21	0.76
Control Delay	8.1	8.1	2.2	10.9	8.5	1.4	39.3	23.0	54.0	70.9
Queue Delay	0.0	0.0	0.0	0.0	0.0	0.0	0.0	0.0	0.0	0.0
Total Delay	8.1	8.1	2.2	10.9	8.5	1.4	39.3	23.0	54.0	70.9
Queue Length 50th (m)	0.6	24.6	0.0	9.3	27.4	0.0	2.3	23.7	5.9	71.3
Queue Length 95th (m)	2.8	38.0	3.1	23.0	44.4	2.0	7.4	48.4	14.6	98.3
Internal Link Dist (m)		1635.6			198.1			1951.8		1542.4
Turn Bay Length (m)	150.0		105.0	150.0		115.0	75.0		105.0	
Base Capacity (vph)	457	3051	836	388	2069	948	174	669	211	663
Starvation Cap Reductn	0	0	0	0	0	0	0	0	0	0
Spillback Cap Reductn	0	0	0	0	0	0	0	0	0	0
Storage Cap Reductn	0	0	0	0	0	0	0	0	0	0
Reduced v/c Ratio	0.02	0.26	0.03	0.27	0.29	0.02	0.06	0.39	0.11	0.42

Intersection Summary

Cycle Length: 120

Actuated Cycle Length: 120

Offset: 0 (0%), Referenced to phase 2:EBTL and 6:WBTL, Start of Green

Natural Cycle: 60

Control Type: Actuated-Coordinated

Splits and Phases: 3: Clarkway Drive/Humber Station Road & Mayfield Road

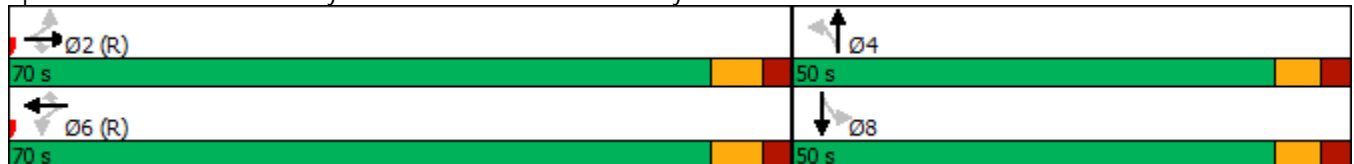

HCM Signalized Intersection Capacity Analysis

3: Clarkway Drive/Humber Station Road & Mayfield Road

Future Background (2028) - Optimized
AM Peak Hour



Movement	EBL	EBT	EBR	WBL	WBT	WBR	NBL	NBT	NBR	SBL	SBT	SBR
Lane Configurations	↘	↑↑↑	↗	↘	↑↑	↗	↘	↗		↘	↗	
Traffic Volume (vph)	8	754	28	102	567	21	11	52	198	23	259	8
Future Volume (vph)	8	754	28	102	567	21	11	52	198	23	259	8
Ideal Flow (vphpl)	1900	1900	1900	1900	1900	1900	1900	1900	1900	1900	1900	1900
Lane Width	3.0	3.5	3.0	3.0	3.5	3.0	3.0	3.5	3.0	3.0	3.5	3.0
Total Lost time (s)	7.3	7.3	7.3	7.3	7.3	7.3	7.0	7.0		7.0	7.0	
Lane Util. Factor	1.00	0.91	1.00	1.00	0.95	1.00	1.00	1.00		1.00	1.00	
Frt	1.00	1.00	0.85	1.00	1.00	0.85	1.00	0.88		1.00	1.00	
Flt Protected	0.95	1.00	1.00	0.95	1.00	1.00	0.95	1.00		0.95	1.00	
Satd. Flow (prot)	1491	4460	1206	1574	3025	1370	1428	1598		1546	1853	
Flt Permitted	0.43	1.00	1.00	0.34	1.00	1.00	0.32	1.00		0.36	1.00	
Satd. Flow (perm)	668	4460	1206	568	3025	1370	487	1598		591	1853	
Peak-hour factor, PHF	0.96	0.96	0.96	0.96	0.96	0.96	0.96	0.96	0.96	0.96	0.96	0.96
Adj. Flow (vph)	8	785	29	106	591	22	11	54	206	24	270	8
RTOR Reduction (vph)	0	0	9	0	0	7	0	121	0	0	0	0
Lane Group Flow (vph)	8	785	20	106	591	15	11	139	0	24	278	0
Heavy Vehicles (%)	13%	15%	25%	7%	18%	10%	18%	2%	4%	9%	1%	0%
Turn Type	Perm	NA	Perm	Perm	NA	Perm	Perm	NA		Perm	NA	
Protected Phases		2			6			4			8	
Permitted Phases	2		2	6		6	4			8		
Actuated Green, G (s)	82.1	82.1	82.1	82.1	82.1	82.1	23.6	23.6		23.6	23.6	
Effective Green, g (s)	82.1	82.1	82.1	82.1	82.1	82.1	23.6	23.6		23.6	23.6	
Actuated g/C Ratio	0.68	0.68	0.68	0.68	0.68	0.68	0.20	0.20		0.20	0.20	
Clearance Time (s)	7.3	7.3	7.3	7.3	7.3	7.3	7.0	7.0		7.0	7.0	
Vehicle Extension (s)	3.0	3.0	3.0	3.0	3.0	3.0	3.0	3.0		3.0	3.0	
Lane Grp Cap (vph)	457	3051	825	388	2069	937	95	314		116	364	
v/s Ratio Prot		0.18			c0.20			0.09			c0.15	
v/s Ratio Perm	0.01		0.02	0.19		0.01	0.02			0.04		
v/c Ratio	0.02	0.26	0.02	0.27	0.29	0.02	0.12	0.44		0.21	0.76	
Uniform Delay, d1	6.1	7.3	6.1	7.4	7.4	6.1	39.6	42.4		40.4	45.6	
Progression Factor	1.00	1.00	1.00	1.00	1.00	1.00	1.00	1.00		1.31	1.27	
Incremental Delay, d2	0.1	0.2	0.1	1.7	0.3	0.0	0.5	1.0		0.9	9.1	
Delay (s)	6.1	7.5	6.1	9.1	7.8	6.1	40.2	43.4		53.8	67.1	
Level of Service	A	A	A	A	A	A	D	D		D	E	
Approach Delay (s)		7.4			7.9			43.3			66.0	
Approach LOS		A			A			D			E	

Intersection Summary

HCM 2000 Control Delay	20.6	HCM 2000 Level of Service	C
HCM 2000 Volume to Capacity ratio	0.39		
Actuated Cycle Length (s)	120.0	Sum of lost time (s)	14.3
Intersection Capacity Utilization	62.8%	ICU Level of Service	B
Analysis Period (min)	15		

c Critical Lane Group

Queues
4: Coleraine Drive & Mayfield Road

Future Background (2028) - Optimized
AM Peak Hour



Lane Group	EBL	EBT	WBL	WBT	NBL	NBT	SBL	SBT
Lane Configurations	↖	↕	↖	↕	↖	↕	↖	↕
Traffic Volume (vph)	286	491	44	503	20	133	67	339
Future Volume (vph)	286	491	44	503	20	133	67	339
Lane Group Flow (vph)	325	615	50	615	23	161	76	626
Turn Type	pm+pt	NA	Perm	NA	Perm	NA	pm+pt	NA
Protected Phases	5	2		6		4	3	8
Permitted Phases	2		6		4		8	
Detector Phase	5	2	6	6	4	4	3	8
Switch Phase								
Minimum Initial (s)	5.0	12.0	12.0	12.0	12.0	12.0	5.0	12.0
Minimum Split (s)	8.0	37.0	37.0	37.0	37.0	37.0	8.0	37.0
Total Split (s)	15.0	80.0	65.0	65.0	32.0	32.0	18.0	50.0
Total Split (%)	11.5%	61.5%	50.0%	50.0%	24.6%	24.6%	13.8%	38.5%
Yellow Time (s)	3.0	4.6	4.6	4.6	4.2	4.2	3.0	4.2
All-Red Time (s)	0.0	2.4	2.4	2.4	2.8	2.8	0.0	2.8
Lost Time Adjust (s)	0.0	0.0	0.0	0.0	0.0	0.0	0.0	0.0
Total Lost Time (s)	3.0	7.0	7.0	7.0	7.0	7.0	3.0	7.0
Lead/Lag	Lead		Lag	Lag	Lag	Lag	Lead	
Lead-Lag Optimize?	Yes		Yes	Yes	Yes	Yes	Yes	
Recall Mode	None	C-Max	C-Max	C-Max	None	None	None	None
v/c Ratio	0.60	0.29	0.13	0.35	0.37	0.38	0.30	0.82
Control Delay	12.5	9.1	19.3	19.1	71.1	54.4	40.9	49.3
Queue Delay	0.0	0.0	0.0	0.0	0.0	0.0	0.0	0.0
Total Delay	12.5	9.1	19.3	19.1	71.1	54.4	40.9	49.3
Queue Length 50th (m)	28.4	30.7	6.5	47.3	5.9	21.1	16.6	71.3
Queue Length 95th (m)	50.6	47.4	16.6	71.9	15.2	31.2	27.6	84.2
Internal Link Dist (m)		290.4		1003.7		192.7		576.8
Turn Bay Length (m)	100.0		85.0		105.0		145.0	
Base Capacity (vph)	545	2095	399	1742	101	679	272	1127
Starvation Cap Reductn	0	0	0	0	0	0	0	0
Spillback Cap Reductn	0	0	0	0	0	0	0	0
Storage Cap Reductn	0	0	0	0	0	0	0	0
Reduced v/c Ratio	0.60	0.29	0.13	0.35	0.23	0.24	0.28	0.56

Intersection Summary

Cycle Length: 130
 Actuated Cycle Length: 130
 Offset: 92 (71%), Referenced to phase 2:EBTL and 6:WBTL, Start of Green
 Natural Cycle: 90
 Control Type: Actuated-Coordinated





















Splits and Phases: 4: Coleraine Drive & Mayfield Road



HCM Signalized Intersection Capacity Analysis

4: Coleraine Drive & Mayfield Road

Future Background (2028) - Optimized
AM Peak Hour

												
Movement	EBL	EBT	EBR	WBL	WBT	WBR	NBL	NBT	NBR	SBL	SBT	SBR
Lane Configurations												
Traffic Volume (vph)	286	491	50	44	503	38	20	133	9	67	339	212
Future Volume (vph)	286	491	50	44	503	38	20	133	9	67	339	212
Ideal Flow (vphpl)	1900	1900	1900	1900	1900	1900	1900	1900	1900	1900	1900	1900
Lane Width	3.0	3.5	3.0	3.0	3.5	3.0	3.0	3.5	3.0	3.0	3.5	3.0
Total Lost time (s)	3.0	7.0		7.0	7.0		7.0	7.0		3.0	7.0	
Lane Util. Factor	1.00	0.95		1.00	0.95		1.00	0.95		1.00	0.95	
Flt	1.00	0.99		1.00	0.99		1.00	0.99		1.00	0.94	
Flt Protected	0.95	1.00		0.95	1.00		0.95	1.00		0.95	1.00	
Satd. Flow (prot)	1560	3069		1685	3233		1532	3513		1452	3180	
Flt Permitted	0.36	1.00		0.42	1.00		0.33	1.00		0.54	1.00	
Satd. Flow (perm)	599	3069		743	3233		527	3513		832	3180	
Peak-hour factor, PHF	0.88	0.88	0.88	0.88	0.88	0.88	0.88	0.88	0.88	0.88	0.88	0.88
Adj. Flow (vph)	325	558	57	50	572	43	23	151	10	76	385	241
RTOR Reduction (vph)	0	4	0	0	4	0	0	4	0	0	89	0
Lane Group Flow (vph)	325	611	0	50	611	0	23	157	0	76	537	0
Heavy Vehicles (%)	8%	16%	2%	0%	8%	26%	10%	0%	11%	16%	0%	15%
Turn Type	pm+pt	NA		Perm	NA		Perm	NA		pm+pt	NA	
Protected Phases	5	2			6			4		3	8	
Permitted Phases	2			6			4			8		
Actuated Green, G (s)	88.0	88.0		69.3	69.3		15.4	15.4		28.0	28.0	
Effective Green, g (s)	88.0	88.0		69.3	69.3		15.4	15.4		28.0	28.0	
Actuated g/C Ratio	0.68	0.68		0.53	0.53		0.12	0.12		0.22	0.22	
Clearance Time (s)	3.0	7.0		7.0	7.0		7.0	7.0		3.0	7.0	
Vehicle Extension (s)	3.0	3.0		3.0	3.0		3.0	3.0		3.0	3.0	
Lane Grp Cap (vph)	521	2077		396	1723		62	416		224	684	
v/s Ratio Prot	c0.08	0.20			0.19			0.04		0.02	c0.17	
v/s Ratio Perm	c0.35			0.07			0.04			0.05		
v/c Ratio	0.62	0.29		0.13	0.35		0.37	0.38		0.34	0.79	
Uniform Delay, d1	9.2	8.5		15.2	17.5		52.8	52.9		42.3	48.2	
Progression Factor	1.00	1.00		1.00	1.00		1.00	1.00		1.00	1.00	
Incremental Delay, d2	2.3	0.4		0.7	0.6		3.7	0.6		0.9	5.9	
Delay (s)	11.5	8.8		15.8	18.0		56.6	53.4		43.2	54.1	
Level of Service	B	A		B	B		E	D		D	D	
Approach Delay (s)		9.8			17.9			53.8			52.9	
Approach LOS		A			B			D			D	
Intersection Summary												
HCM 2000 Control Delay			27.3				HCM 2000 Level of Service			C		
HCM 2000 Volume to Capacity ratio			0.70									
Actuated Cycle Length (s)			130.0			Sum of lost time (s)			20.0			
Intersection Capacity Utilization			78.0%			ICU Level of Service			D			
Analysis Period (min)			15									

c Critical Lane Group

Queues

Future Background (2028) - Optimized

5: Coleraine Drive & Private Access/George Bolton Parkway

AM Peak Hour



Lane Group	EBL	EBT	WBL	WBT	NBL	NBT	SBL	SBT	SBR
Lane Configurations	↖	↗	↖	↗	↖	↗	↖	↗	↗
Traffic Volume (vph)	4	12	63	23	30	339	84	476	11
Future Volume (vph)	4	12	63	23	30	339	84	476	11
Lane Group Flow (vph)	5	29	73	191	35	506	98	553	13
Turn Type	Perm	NA	Perm	NA	Perm	NA	Perm	NA	Perm
Protected Phases		8		4		6		2	
Permitted Phases	8		4		6		2		2
Detector Phase	8	8	4	4	6	6	2	2	2
Switch Phase									
Minimum Initial (s)	8.0	8.0	12.0	12.0	12.0	12.0	12.0	12.0	12.0
Minimum Split (s)	32.5	32.5	32.5	32.5	34.2	34.2	33.7	33.7	33.7
Total Split (s)	45.0	45.0	45.0	45.0	55.0	55.0	55.0	55.0	55.0
Total Split (%)	45.0%	45.0%	45.0%	45.0%	55.0%	55.0%	55.0%	55.0%	55.0%
Yellow Time (s)	4.0	4.0	4.0	4.0	4.2	4.2	4.2	4.2	4.2
All-Red Time (s)	3.5	3.5	3.5	3.5	2.5	2.5	2.5	2.5	2.5
Lost Time Adjust (s)	0.0	0.0	0.0	0.0	0.0	0.0	0.0	0.0	0.0
Total Lost Time (s)	7.5	7.5	7.5	7.5	6.7	6.7	6.7	6.7	6.7
Lead/Lag									
Lead-Lag Optimize?									
Recall Mode	None	None	None	None	C-Max	C-Max	C-Max	C-Max	C-Max
v/c Ratio	0.04	0.15	0.52	0.56	0.08	0.24	0.18	0.25	0.01
Control Delay	35.2	24.0	52.1	15.3	5.6	5.0	6.2	5.6	0.0
Queue Delay	0.0	0.0	0.0	0.0	0.0	0.0	0.0	0.0	0.0
Total Delay	35.2	24.0	52.1	15.3	5.6	5.0	6.2	5.6	0.0
Queue Length 50th (m)	0.9	2.6	14.2	5.0	1.7	13.1	5.2	16.4	0.0
Queue Length 95th (m)	3.9	9.7	25.9	21.4	5.7	23.3	13.4	28.2	0.0
Internal Link Dist (m)		152.4		468.8		784.9		1711.9	
Turn Bay Length (m)	70.0		105.0		75.0		100.0		100.0
Base Capacity (vph)	345	486	369	633	458	2127	556	2216	1001
Starvation Cap Reductn	0	0	0	0	0	0	0	0	0
Spillback Cap Reductn	0	0	0	0	0	0	0	0	0
Storage Cap Reductn	0	0	0	0	0	0	0	0	0
Reduced v/c Ratio	0.01	0.06	0.20	0.30	0.08	0.24	0.18	0.25	0.01

Intersection Summary

Cycle Length: 100

Actuated Cycle Length: 100

Offset: 0 (0%), Referenced to phase 2:SBTL and 6:NBTL, Start of Green

Natural Cycle: 70

Control Type: Actuated-Coordinated

Splits and Phases: 5: Coleraine Drive & Private Access/George Bolton Parkway

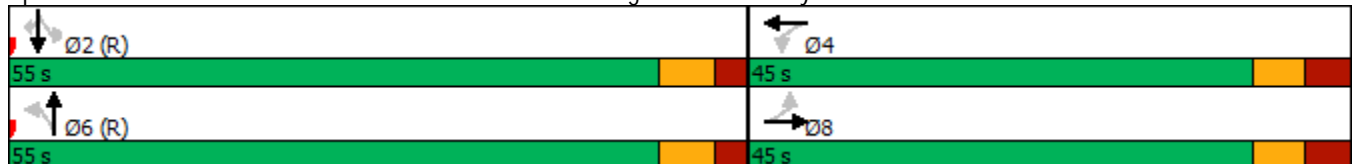

HCM Signalized Intersection Capacity Analysis

Future Background (2028) - Optimized

5: Coleraine Drive & Private Access/George Bolton Parkway

AM Peak Hour



Movement	EBL	EBT	EBR	WBL	WBT	WBR	NBL	NBT	NBR	SBL	SBT	SBR
Lane Configurations	↖	↗		↖	↗		↖	↕		↖	↗	↖
Traffic Volume (vph)	4	12	13	63	23	141	30	339	96	84	476	11
Future Volume (vph)	4	12	13	63	23	141	30	339	96	84	476	11
Ideal Flow (vphpl)	1900	1900	1900	1900	1900	1900	1900	1900	1900	1900	1900	1900
Lane Width	3.0	3.5	3.0	3.0	3.5	3.0	3.0	3.5	3.0	3.0	3.5	3.0
Total Lost time (s)	7.5	7.5		7.5	7.5		6.7	6.7		6.7	6.7	6.7
Lane Util. Factor	1.00	1.00		1.00	1.00		1.00	0.95		1.00	0.95	1.00
Flt Protected	1.00	0.92		1.00	0.87		1.00	0.97		1.00	1.00	0.85
Flt Permitted	0.95	1.00		0.95	1.00		0.95	1.00		0.95	1.00	1.00
Satd. Flow (prot)	1685	1271		1267	1417		1370	2958		1589	3104	1383
Flt Permitted	0.52	1.00		0.74	1.00		0.45	1.00		0.47	1.00	1.00
Satd. Flow (perm)	921	1271		984	1417		642	2958		779	3104	1383
Peak-hour factor, PHF	0.86	0.86	0.86	0.86	0.86	0.86	0.86	0.86	0.86	0.86	0.86	0.86
Adj. Flow (vph)	5	14	15	73	27	164	35	394	112	98	553	13
RTOR Reduction (vph)	0	13	0	0	140	0	0	15	0	0	0	4
Lane Group Flow (vph)	5	16	0	73	51	0	35	491	0	98	553	9
Heavy Vehicles (%)	0%	42%	31%	33%	43%	11%	23%	16%	19%	6%	15%	9%
Turn Type	Perm	NA		Perm	NA		Perm	NA		Perm	NA	Perm
Protected Phases		8			4			6			2	
Permitted Phases	8			4			6			2		2
Actuated Green, G (s)	14.4	14.4		14.4	14.4		71.4	71.4		71.4	71.4	71.4
Effective Green, g (s)	14.4	14.4		14.4	14.4		71.4	71.4		71.4	71.4	71.4
Actuated g/C Ratio	0.14	0.14		0.14	0.14		0.71	0.71		0.71	0.71	0.71
Clearance Time (s)	7.5	7.5		7.5	7.5		6.7	6.7		6.7	6.7	6.7
Vehicle Extension (s)	3.0	3.0		3.0	3.0		3.0	3.0		3.0	3.0	3.0
Lane Grp Cap (vph)	132	183		141	204		458	2112		556	2216	987
v/s Ratio Prot		0.01			0.04			0.17			c0.18	
v/s Ratio Perm	0.01			c0.07			0.05			0.13		0.01
v/c Ratio	0.04	0.09		0.52	0.25		0.08	0.23		0.18	0.25	0.01
Uniform Delay, d1	36.8	37.1		39.6	38.0		4.3	4.9		4.7	5.0	4.1
Progression Factor	1.00	1.00		1.00	1.00		1.00	1.00		1.00	1.00	1.00
Incremental Delay, d2	0.1	0.2		3.2	0.6		0.3	0.3		0.7	0.3	0.0
Delay (s)	37.0	37.3		42.8	38.6		4.7	5.2		5.4	5.2	4.1
Level of Service	D	D		D	D		A	A		A	A	A
Approach Delay (s)		37.3			39.8			5.1			5.2	
Approach LOS		D			D			A			A	

Intersection Summary

HCM 2000 Control Delay	12.0	HCM 2000 Level of Service	B
HCM 2000 Volume to Capacity ratio	0.29		
Actuated Cycle Length (s)	100.0	Sum of lost time (s)	14.2
Intersection Capacity Utilization	50.7%	ICU Level of Service	A
Analysis Period (min)	15		

c Critical Lane Group

Queues
6: Highway 50 & George Bolton Parkway/Private Access

Future Background (2028) - Optimized
AM Peak Hour



Lane Group	EBL	EBT	WBT	NBL	NBT	SBL	SBT	SBR
Lane Configurations								
Traffic Volume (vph)	76	0	0	153	886	3	1144	138
Future Volume (vph)	76	0	0	153	886	3	1144	138
Lane Group Flow (vph)	79	108	1	159	923	3	1192	144
Turn Type	Perm	NA	NA	pm+pt	NA	Perm	NA	Perm
Protected Phases		8	4	1	6		2	
Permitted Phases	8			6		2		2
Detector Phase	8	8	4	1	6	2	2	2
Switch Phase								
Minimum Initial (s)	8.0	8.0	8.0	5.0	12.0	12.0	12.0	12.0
Minimum Split (s)	32.6	32.6	32.6	8.0	27.3	27.3	27.3	27.3
Total Split (s)	35.0	35.0	35.0	10.0	85.0	75.0	75.0	75.0
Total Split (%)	29.2%	29.2%	29.2%	8.3%	70.8%	62.5%	62.5%	62.5%
Yellow Time (s)	4.0	4.0	4.0	3.0	4.0	4.0	4.0	4.0
All-Red Time (s)	2.6	2.6	2.6	0.0	2.3	2.3	2.3	2.3
Lost Time Adjust (s)	0.0	0.0	0.0	0.0	0.0	0.0	0.0	0.0
Total Lost Time (s)	6.6	6.6	6.6	3.0	6.3	6.3	6.3	6.3
Lead/Lag				Lead		Lag	Lag	Lag
Lead-Lag Optimize?				Yes		Yes	Yes	Yes
Recall Mode	None	None	None	None	C-Max	C-Max	C-Max	C-Max
v/c Ratio	0.59	0.40	0.00	0.52	0.35	0.01	0.53	0.14
Control Delay	67.3	5.8	0.0	9.2	4.7	9.0	11.8	2.1
Queue Delay	0.0	0.0	0.0	0.0	0.0	0.0	0.0	0.0
Total Delay	67.3	5.8	0.0	9.2	4.7	9.0	11.8	2.1
Queue Length 50th (m)	18.9	0.0	0.0	6.7	29.8	0.2	70.3	0.5
Queue Length 95th (m)	34.2	4.3	0.0	15.3	48.3	1.7	114.1	9.1
Internal Link Dist (m)		846.5	43.0		1045.6		1307.8	
Turn Bay Length (m)	85.0			40.0		135.0		60.0
Base Capacity (vph)	286	399	515	306	2655	370	2235	1024
Starvation Cap Reductn	0	0	0	0	0	0	0	0
Spillback Cap Reductn	0	0	0	0	0	0	0	0
Storage Cap Reductn	0	0	0	0	0	0	0	0
Reduced v/c Ratio	0.28	0.27	0.00	0.52	0.35	0.01	0.53	0.14

Intersection Summary

Cycle Length: 120
 Actuated Cycle Length: 120
 Offset: 113 (94%), Referenced to phase 2:SBTL and 6:NBTL, Start of Green
 Natural Cycle: 80
 Control Type: Actuated-Coordinated

Splits and Phases: 6: Highway 50 & George Bolton Parkway/Private Access

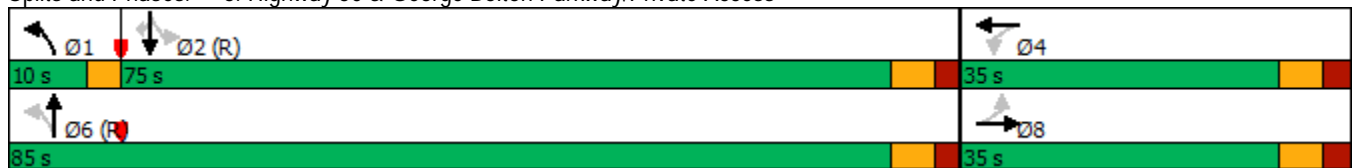

HCM Signalized Intersection Capacity Analysis
6: Highway 50 & George Bolton Parkway/Private Access

Future Background (2028) - Optimized
AM Peak Hour



Movement	EBL	EBT	EBR	WBL	WBT	WBR	NBL	NBT	NBR	SBL	SBT	SBR
Lane Configurations	↖	↗			↔		↖	↕		↖	↗	↗
Traffic Volume (vph)	76	0	104	0	0	1	153	886	0	3	1144	138
Future Volume (vph)	76	0	104	0	0	1	153	886	0	3	1144	138
Ideal Flow (vphpl)	1900	1900	1900	1900	1900	1900	1900	1900	1900	1900	1900	1900
Lane Width	3.0	3.5	3.0	3.0	3.5	3.0	3.0	3.5	3.0	3.0	3.5	3.0
Total Lost time (s)	6.6	6.6			6.6		3.0	6.3		6.3	6.3	6.3
Lane Util. Factor	1.00	1.00			1.00		1.00	0.95		1.00	0.95	1.00
Frt	1.00	0.85			0.86		1.00	1.00		1.00	1.00	0.85
Flt Protected	0.95	1.00			1.00		0.95	1.00		0.95	1.00	1.00
Satd. Flow (prot)	1518	1166			1625		1370	3400		1685	3305	1449
Flt Permitted	0.76	1.00			1.00		0.19	1.00		0.31	1.00	1.00
Satd. Flow (perm)	1210	1166			1625		270	3400		549	3305	1449
Peak-hour factor, PHF	0.96	0.96	0.96	0.96	0.96	0.96	0.96	0.96	0.96	0.96	0.96	0.96
Adj. Flow (vph)	79	0	108	0	0	1	159	923	0	3	1192	144
RTOR Reduction (vph)	0	96	0	0	1	0	0	0	0	0	0	44
Lane Group Flow (vph)	79	12	0	0	0	0	159	923	0	3	1192	100
Heavy Vehicles (%)	11%	0%	37%	0%	0%	0%	23%	5%	0%	0%	8%	4%
Turn Type	Perm	NA			NA		pm+pt	NA		Perm	NA	Perm
Protected Phases		8			4		1	6			2	
Permitted Phases	8			4			6			2		2
Actuated Green, G (s)	13.4	13.4			13.4		93.7	93.7		81.1	81.1	81.1
Effective Green, g (s)	13.4	13.4			13.4		93.7	93.7		81.1	81.1	81.1
Actuated g/C Ratio	0.11	0.11			0.11		0.78	0.78		0.68	0.68	0.68
Clearance Time (s)	6.6	6.6			6.6		3.0	6.3		6.3	6.3	6.3
Vehicle Extension (s)	3.0	3.0			3.0		3.0	3.0		3.0	3.0	3.0
Lane Grp Cap (vph)	135	130			181		298	2654		371	2233	979
v/s Ratio Prot		0.01			0.00		c0.04	0.27			0.36	
v/s Ratio Perm	c0.07						c0.37			0.01		0.07
v/c Ratio	0.59	0.09			0.00		0.53	0.35		0.01	0.53	0.10
Uniform Delay, d1	50.7	47.8			47.4		5.7	4.0		6.3	9.9	6.8
Progression Factor	1.00	1.00			1.00		1.00	1.00		1.00	1.00	1.00
Incremental Delay, d2	6.3	0.3			0.0		1.8	0.4		0.0	0.9	0.2
Delay (s)	57.0	48.2			47.4		7.5	4.3		6.4	10.8	7.0
Level of Service	E	D			D		A	A		A	B	A
Approach Delay (s)		51.9			47.4			4.8			10.4	
Approach LOS		D			D			A			B	













Intersection Summary

HCM 2000 Control Delay	11.0	HCM 2000 Level of Service	B
HCM 2000 Volume to Capacity ratio	0.55		
Actuated Cycle Length (s)	120.0	Sum of lost time (s)	15.9
Intersection Capacity Utilization	65.1%	ICU Level of Service	C
Analysis Period (min)	15		

c Critical Lane Group

HCM Unsignalized Intersection Capacity Analysis
 9: Humber Station Road & Subject Lands Site Access 1

Future Background (2028) - Optimized
 AM Peak Hour

						
Movement	WBL	WBR	NBT	NBR	SBL	SBT
Lane Configurations						
Traffic Volume (veh/h)	0	0	81	0	0	290
Future Volume (Veh/h)	0	0	81	0	0	290
Sign Control	Stop		Free		Free	
Grade	0%		0%		0%	
Peak Hour Factor	1.00	1.00	1.00	1.00	1.00	1.00
Hourly flow rate (vph)	0	0	81	0	0	290
Pedestrians						
Lane Width (m)						
Walking Speed (m/s)						
Percent Blockage						
Right turn flare (veh)						
Median type	None			None		
Median storage veh						
Upstream signal (m)						
pX, platoon unblocked						
vC, conflicting volume	371	81			81	
vC1, stage 1 conf vol						
vC2, stage 2 conf vol						
vCu, unblocked vol	371	81			81	
tC, single (s)	6.4	6.2			4.1	
tC, 2 stage (s)						
tF (s)	3.5	3.3			2.2	
p0 queue free %	100	100			100	
cM capacity (veh/h)	634	985			1529	
Direction, Lane #	WB 1	WB 2	NB 1	NB 2	SB 1	SB 2
Volume Total	0	0	81	0	0	290
Volume Left	0	0	0	0	0	0
Volume Right	0	0	0	0	0	0
cSH	1700	1700	1700	1700	1700	1700
Volume to Capacity	0.00	0.00	0.05	0.00	0.00	0.17
Queue Length 95th (m)	0.0	0.0	0.0	0.0	0.0	0.0
Control Delay (s)	0.0	0.0	0.0	0.0	0.0	0.0
Lane LOS	A	A				
Approach Delay (s)	0.0		0.0		0.0	
Approach LOS	A					
Intersection Summary						
Average Delay			0.0			
Intersection Capacity Utilization			18.6%		ICU Level of Service	A
Analysis Period (min)			15			

HCM Unsignalized Intersection Capacity Analysis
 24: Mayfield Road & Triangle Lands

Future Background (2028) - Optimized
 AM Peak Hour



Movement	EBL	EBT	WBT	WBR	SBL	SBR	
Lane Configurations	↶	↷	↷		↶	↷	
Traffic Volume (veh/h)	160	815	618	108	33	72	
Future Volume (Veh/h)	160	815	618	108	33	72	
Sign Control		Free	Free		Stop		
Grade		0%	0%		0%		
Peak Hour Factor	1.00	1.00	1.00	1.00	1.00	1.00	
Hourly flow rate (vph)	160	815	618	108	33	72	
Pedestrians							
Lane Width (m)							
Walking Speed (m/s)							
Percent Blockage							
Right turn flare (veh)							
Median type		None	None				
Median storage (veh)							
Upstream signal (m)			314				
pX, platoon unblocked	0.93				0.93	0.93	
vC, conflicting volume	726				1400	363	
vC1, stage 1 conf vol							
vC2, stage 2 conf vol							
vCu, unblocked vol	547				1273	155	
tC, single (s)	4.2				7.0	7.2	
tC, 2 stage (s)							
tF (s)	2.3				3.6	3.4	
p0 queue free %	82				70	91	
cM capacity (veh/h)	913				112	769	
Direction, Lane #	EB 1	EB 2	EB 3	WB 1	WB 2	SB 1	SB 2
Volume Total	160	408	408	412	314	33	72
Volume Left	160	0	0	0	0	33	0
Volume Right	0	0	0	0	108	0	72
cSH	913	1700	1700	1700	1700	112	769
Volume to Capacity	0.18	0.24	0.24	0.24	0.18	0.30	0.09
Queue Length 95th (m)	5.1	0.0	0.0	0.0	0.0	9.0	2.5
Control Delay (s)	9.8	0.0	0.0	0.0	0.0	50.2	10.2
Lane LOS	A					F	B
Approach Delay (s)	1.6			0.0		22.7	
Approach LOS						C	
Intersection Summary							
Average Delay			2.2				
Intersection Capacity Utilization			42.7%		ICU Level of Service		A
Analysis Period (min)			15				

Queues
1: Coleraine Drive & Healey Road

Future Background (2028) - Optimized
PM Peak Hour



Lane Group	EBL	EBT	WBL	WBT	NBL	NBT	SBL	SBT
Lane Configurations	↖	↗	↖	↗	↖	↕	↖	↕
Traffic Volume (vph)	117	172	56	312	301	350	47	188
Future Volume (vph)	117	172	56	312	301	350	47	188
Lane Group Flow (vph)	129	352	62	436	331	442	52	283
Turn Type	Perm	NA	Perm	NA	Perm	NA	Perm	NA
Protected Phases		8		4		6		2
Permitted Phases	8		4		6		2	
Detector Phase	8	8	4	4	6	6	2	2
Switch Phase								
Minimum Initial (s)	8.0	8.0	8.0	8.0	8.0	8.0	8.0	8.0
Minimum Split (s)	32.8	32.8	32.8	32.8	36.7	36.7	36.7	36.7
Total Split (s)	33.0	33.0	33.0	33.0	37.0	37.0	37.0	37.0
Total Split (%)	47.1%	47.1%	47.1%	47.1%	52.9%	52.9%	52.9%	52.9%
Yellow Time (s)	4.0	4.0	4.0	4.0	4.6	4.6	4.6	4.6
All-Red Time (s)	2.8	2.8	2.8	2.8	2.1	2.1	2.1	2.1
Lost Time Adjust (s)	0.0	0.0	0.0	0.0	0.0	0.0	0.0	0.0
Total Lost Time (s)	6.8	6.8	6.8	6.8	6.7	6.7	6.7	6.7
Lead/Lag								
Lead-Lag Optimize?								
Recall Mode	None	None	None	None	C-Max	C-Max	C-Max	C-Max
v/c Ratio	0.83	0.62	0.30	0.80	0.65	0.29	0.14	0.19
Control Delay	61.5	20.7	21.2	32.2	22.6	11.0	12.4	8.2
Queue Delay	0.0	0.0	0.0	0.0	0.0	0.0	0.0	0.0
Total Delay	61.5	20.7	21.2	32.2	22.6	11.0	12.4	8.2
Queue Length 50th (m)	16.1	31.9	6.4	51.1	32.1	16.5	3.7	7.6
Queue Length 95th (m)	#41.1	52.1	14.8	76.0	#79.7	29.2	11.1	16.1
Internal Link Dist (m)		1349.5		424.0		1711.9		1121.0
Turn Bay Length (m)	55.0		50.0		80.0		155.0	
Base Capacity (vph)	193	689	255	672	512	1513	372	1487
Starvation Cap Reductn	0	0	0	0	0	0	0	0
Spillback Cap Reductn	0	0	0	0	0	0	0	0
Storage Cap Reductn	0	0	0	0	0	0	0	0
Reduced v/c Ratio	0.67	0.51	0.24	0.65	0.65	0.29	0.14	0.19

Intersection Summary





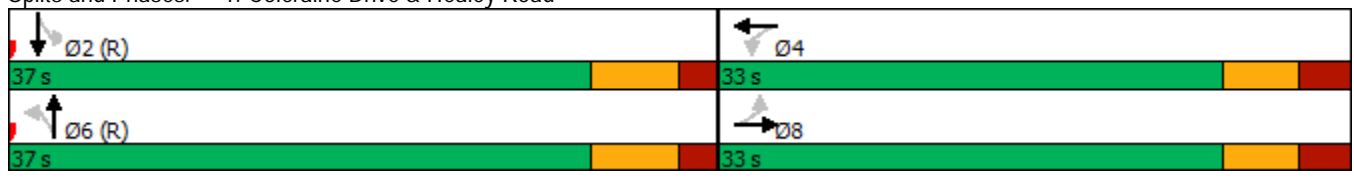

















Cycle Length: 70
 Actuated Cycle Length: 70
 Offset: 12 (17%), Referenced to phase 2:SBTL and 6:NBTL, Start of Green
 Natural Cycle: 70
 Control Type: Actuated-Coordinated
 # 95th percentile volume exceeds capacity, queue may be longer.
 Queue shown is maximum after two cycles.

Splits and Phases: 1: Coleraine Drive & Healey Road



HCM Signalized Intersection Capacity Analysis
1: Coleraine Drive & Healey Road

Future Background (2028) - Optimized
PM Peak Hour

												
Movement	EBL	EBT	EBR	WBL	WBT	WBR	NBL	NBT	NBR	SBL	SBT	SBR
Lane Configurations												
Traffic Volume (vph)	117	172	148	56	312	85	301	350	52	47	188	69
Future Volume (vph)	117	172	148	56	312	85	301	350	52	47	188	69
Ideal Flow (vphpl)	1900	1900	1900	1900	1900	1900	1900	1900	1900	1900	1900	1900
Lane Width	3.0	3.5	3.0	3.0	3.5	3.0	3.0	3.5	3.0	3.0	3.5	3.0
Total Lost time (s)	6.8	6.8		6.8	6.8		6.7	6.7		6.7	6.7	
Lane Util. Factor	1.00	1.00		1.00	1.00		1.00	0.95		1.00	0.95	
Frt	1.00	0.93		1.00	0.97		1.00	0.98		1.00	0.96	
Flt Protected	0.95	1.00		0.95	1.00		0.95	1.00		0.95	1.00	
Satd. Flow (prot)	1652	1723		1546	1759		1668	2970		1416	2872	
Flt Permitted	0.30	1.00		0.42	1.00		0.58	1.00		0.50	1.00	
Satd. Flow (perm)	518	1723		681	1759		1015	2970		739	2872	
Peak-hour factor, PHF	0.91	0.91	0.91	0.91	0.91	0.91	0.91	0.91	0.91	0.91	0.91	0.91
Adj. Flow (vph)	129	189	163	62	343	93	331	385	57	52	207	76
RTOR Reduction (vph)	0	49	0	0	15	0	0	14	0	0	38	0
Lane Group Flow (vph)	129	303	0	62	421	0	331	428	0	52	245	0
Heavy Vehicles (%)	2%	1%	2%	9%	0%	16%	1%	18%	17%	19%	26%	1%
Turn Type	Perm	NA		Perm	NA		Perm	NA		Perm	NA	
Protected Phases		8			4			6			2	
Permitted Phases	8			4			6			2		
Actuated Green, G (s)	21.2	21.2		21.2	21.2		35.3	35.3		35.3	35.3	
Effective Green, g (s)	21.2	21.2		21.2	21.2		35.3	35.3		35.3	35.3	
Actuated g/C Ratio	0.30	0.30		0.30	0.30		0.50	0.50		0.50	0.50	
Clearance Time (s)	6.8	6.8		6.8	6.8		6.7	6.7		6.7	6.7	
Vehicle Extension (s)	3.0	3.0		3.0	3.0		3.0	3.0		3.0	3.0	
Lane Grp Cap (vph)	156	521		206	532		511	1497		372	1448	
v/s Ratio Prot		0.18			0.24			0.14			0.09	
v/s Ratio Perm	c0.25			0.09			c0.33			0.07		
v/c Ratio	0.83	0.58		0.30	0.79		0.65	0.29		0.14	0.17	
Uniform Delay, d1	22.7	20.6		18.7	22.4		12.8	10.0		9.3	9.4	
Progression Factor	1.00	1.00		1.00	1.00		1.00	1.00		1.00	1.00	
Incremental Delay, d2	28.7	1.7		0.8	7.9		6.2	0.5		0.8	0.3	
Delay (s)	51.4	22.3		19.5	30.2		19.0	10.5		10.0	9.7	
Level of Service	D	C		B	C		B	B		B	A	
Approach Delay (s)		30.1			28.9			14.2			9.7	
Approach LOS		C			C			B			A	
Intersection Summary												
HCM 2000 Control Delay			20.6				HCM 2000 Level of Service				C	
HCM 2000 Volume to Capacity ratio			0.71									
Actuated Cycle Length (s)			70.0				Sum of lost time (s)				13.5	
Intersection Capacity Utilization			74.8%				ICU Level of Service				D	
Analysis Period (min)			15									

c Critical Lane Group

Queues
2: Humber Station Road & Healey Road

Future Background (2028) - Optimized
PM Peak Hour

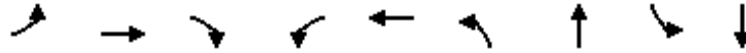

Lane Group	EBL	EBT	EBR	WBL	WBT	NBL	NBT	SBL	SBT
Lane Configurations	↶	↑	↷	↶	↷	↶	↷	↶	↷
Traffic Volume (vph)	21	308	14	34	627	54	206	25	47
Future Volume (vph)	21	308	14	34	627	54	206	25	47
Lane Group Flow (vph)	22	318	14	35	669	56	286	26	54
Turn Type	Perm	NA	Perm	pm+pt	NA	Perm	NA	Perm	NA
Protected Phases		4		3	8		2		6
Permitted Phases	4		4	8		2		6	
Detector Phase	4	4	4	3	8	2	2	6	6
Switch Phase									
Minimum Initial (s)	8.0	8.0	8.0	5.0	8.0	8.0	8.0	8.0	8.0
Minimum Split (s)	24.8	24.8	24.8	9.5	24.8	24.7	24.7	24.7	24.7
Total Split (s)	62.0	62.0	62.0	10.0	72.0	48.0	48.0	48.0	48.0
Total Split (%)	51.7%	51.7%	51.7%	8.3%	60.0%	40.0%	40.0%	40.0%	40.0%
Yellow Time (s)	4.0	4.0	4.0	3.0	4.0	4.6	4.6	4.6	4.6
All-Red Time (s)	2.8	2.8	2.8	0.0	2.8	2.1	2.1	2.1	2.1
Lost Time Adjust (s)	0.0	0.0	0.0	0.0	0.0	0.0	0.0	0.0	0.0
Total Lost Time (s)	6.8	6.8	6.8	3.0	6.8	6.7	6.7	6.7	6.7
Lead/Lag	Lag	Lag	Lag	Lead					
Lead-Lag Optimize?	Yes	Yes	Yes	Yes					
Recall Mode	None	None	None	None	None	C-Max	C-Max	C-Max	C-Max
v/c Ratio	0.17	0.44	0.02	0.09	0.82	0.11	0.35	0.06	0.07
Control Delay	26.0	28.7	0.1	14.8	38.0	8.7	7.6	23.5	20.6
Queue Delay	0.0	0.0	0.0	0.0	0.0	0.0	0.0	0.0	0.0
Total Delay	26.0	28.7	0.1	14.8	38.0	8.7	7.6	23.5	20.6
Queue Length 50th (m)	3.7	60.5	0.0	4.5	141.0	2.2	9.4	3.6	6.7
Queue Length 95th (m)	9.4	75.3	0.0	8.6	161.2	m6.0	21.7	11.1	17.1
Internal Link Dist (m)		465.5			1349.5		1464.0		452.2
Turn Bay Length (m)	30.0			60.0		30.0		30.0	
Base Capacity (vph)	155	847	681	401	1004	526	806	411	816
Starvation Cap Reductn	0	0	0	0	0	0	0	0	0
Spillback Cap Reductn	0	0	0	0	0	0	0	0	0
Storage Cap Reductn	0	0	0	0	0	0	0	0	0
Reduced v/c Ratio	0.14	0.38	0.02	0.09	0.67	0.11	0.35	0.06	0.07

Intersection Summary

Cycle Length: 120
 Actuated Cycle Length: 120
 Offset: 0 (0%), Referenced to phase 2:NBTL and 6:SBTL, Start of Green
 Natural Cycle: 60
 Control Type: Actuated-Coordinated
 m Volume for 95th percentile queue is metered by upstream signal.

Splits and Phases: 2: Humber Station Road & Healey Road

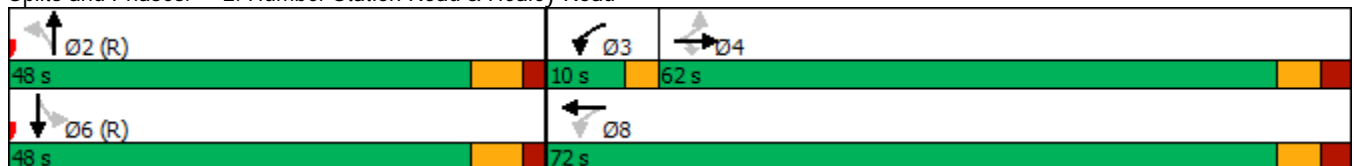

HCM Signalized Intersection Capacity Analysis

2: Humber Station Road & Healey Road

Future Background (2028) - Optimized
PM Peak Hour



Movement	EBL	EBT	EBR	WBL	WBT	WBR	NBL	NBT	NBR	SBL	SBT	SBR
Lane Configurations												
Traffic Volume (vph)	21	308	14	34	627	22	54	206	72	25	47	6
Future Volume (vph)	21	308	14	34	627	22	54	206	72	25	47	6
Ideal Flow (vphpl)	1900	1900	1900	1900	1900	1900	1900	1900	1900	1900	1900	1900
Lane Width	3.0	3.5	3.0	3.0	3.5	3.0	3.0	3.5	3.0	3.0	3.5	3.0
Total Lost time (s)	6.8	6.8	6.8	3.0	6.8		6.7	6.7		6.7	6.7	
Lane Util. Factor	1.00	1.00	1.00	1.00	1.00		1.00	1.00		1.00	1.00	
Frt	1.00	1.00	0.85	1.00	0.99		1.00	0.96		1.00	0.98	
Flt Protected	0.95	1.00	1.00	0.95	1.00		0.95	1.00		0.95	1.00	
Satd. Flow (prot)	1685	1842	1409	1636	1848		1546	1779		1685	1815	
Flt Permitted	0.19	1.00	1.00	0.43	1.00		0.72	1.00		0.52	1.00	
Satd. Flow (perm)	337	1842	1409	743	1848		1174	1779		918	1815	
Peak-hour factor, PHF	0.97	0.97	0.97	0.97	0.97	0.97	0.97	0.97	0.97	0.97	0.97	0.97
Adj. Flow (vph)	22	318	14	35	646	23	56	212	74	26	48	6
RTOR Reduction (vph)	0	0	9	0	1	0	0	9	0	0	3	0
Lane Group Flow (vph)	22	318	5	35	668	0	56	277	0	26	51	0
Heavy Vehicles (%)	0%	2%	7%	3%	1%	5%	9%	1%	3%	0%	2%	0%
Turn Type	Perm	NA	Perm	pm+pt	NA		Perm	NA		Perm	NA	
Protected Phases		4		3	8			2			6	
Permitted Phases	4		4	8			2			6		
Actuated Green, G (s)	46.7	46.7	46.7	53.9	53.9		52.6	52.6		52.6	52.6	
Effective Green, g (s)	46.7	46.7	46.7	53.9	53.9		52.6	52.6		52.6	52.6	
Actuated g/C Ratio	0.39	0.39	0.39	0.45	0.45		0.44	0.44		0.44	0.44	
Clearance Time (s)	6.8	6.8	6.8	3.0	6.8		6.7	6.7		6.7	6.7	
Vehicle Extension (s)	3.0	3.0	3.0	3.0	3.0		3.0	3.0		3.0	3.0	
Lane Grp Cap (vph)	131	716	548	364	830		514	779		402	795	
v/s Ratio Prot		0.17		0.00	c0.36			c0.16			0.03	
v/s Ratio Perm	0.07		0.00	0.04			0.05			0.03		
v/c Ratio	0.17	0.44	0.01	0.10	0.80		0.11	0.36		0.06	0.06	
Uniform Delay, d1	24.0	27.1	22.5	19.2	28.5		19.9	22.4		19.5	19.5	
Progression Factor	1.00	1.00	1.00	1.00	1.00		0.36	0.28		1.00	1.00	
Incremental Delay, d2	0.6	0.4	0.0	0.1	5.7		0.4	1.1		0.3	0.2	
Delay (s)	24.6	27.5	22.5	19.3	34.2		7.6	7.5		19.8	19.6	
Level of Service	C	C	C	B	C		A	A		B	B	
Approach Delay (s)		27.1			33.5			7.5			19.7	
Approach LOS		C			C			A			B	

Intersection Summary

HCM 2000 Control Delay	25.2	HCM 2000 Level of Service	C
HCM 2000 Volume to Capacity ratio	0.60		
Actuated Cycle Length (s)	120.0	Sum of lost time (s)	16.5
Intersection Capacity Utilization	66.4%	ICU Level of Service	C
Analysis Period (min)	15		

c Critical Lane Group

Queues

Future Background (2028) - Optimized

3: Clarkway Drive/Humber Station Road & Mayfield Road

PM Peak Hour

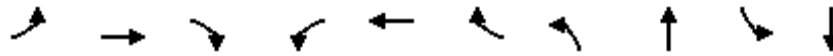

Lane Group	EBL	EBT	EBR	WBL	WBT	WBR	NBL	NBT	SBL	SBT
Lane Configurations	↔	↑↑↑	↗	↖	↑↑	↗	↖	↑	↖	↗
Traffic Volume (vph)	10	688	19	135	828	42	59	270	11	65
Future Volume (vph)	10	688	19	135	828	42	59	270	11	65
Lane Group Flow (vph)	10	709	20	139	854	43	61	444	11	79
Turn Type	Perm	NA	Perm	Perm	NA	Perm	Perm	NA	Perm	NA
Protected Phases		2			6			4		8
Permitted Phases	2		2	6		6	4		8	
Detector Phase	2	2	2	6	6	6	4	4	8	8
Switch Phase										
Minimum Initial (s)	12.0	12.0	12.0	12.0	12.0	12.0	8.0	8.0	8.0	8.0
Minimum Split (s)	27.3	27.3	27.3	27.3	27.3	27.3	26.0	26.0	26.0	26.0
Total Split (s)	62.0	62.0	62.0	62.0	62.0	62.0	58.0	58.0	58.0	58.0
Total Split (%)	51.7%	51.7%	51.7%	51.7%	51.7%	51.7%	48.3%	48.3%	48.3%	48.3%
Yellow Time (s)	4.6	4.6	4.6	4.6	4.6	4.6	4.2	4.2	4.2	4.2
All-Red Time (s)	2.7	2.7	2.7	2.7	2.7	2.7	2.8	2.8	2.8	2.8
Lost Time Adjust (s)	0.0	0.0	0.0	0.0	0.0	0.0	0.0	0.0	0.0	0.0
Total Lost Time (s)	7.3	7.3	7.3	7.3	7.3	7.3	7.0	7.0	7.0	7.0
Lead/Lag										
Lead-Lag Optimize?										
Recall Mode	C-Max	C-Max	C-Max	C-Max	C-Max	C-Max	None	None	None	None
v/c Ratio	0.04	0.26	0.02	0.40	0.45	0.05	0.19	0.83	0.12	0.16
Control Delay	14.4	13.5	2.1	20.1	16.2	4.5	30.3	50.0	29.5	30.2
Queue Delay	0.0	0.0	0.0	0.0	0.0	0.0	0.0	0.0	0.0	0.0
Total Delay	14.4	13.5	2.1	20.1	16.2	4.5	30.3	50.0	29.5	30.2
Queue Length 50th (m)	1.0	29.9	0.0	17.7	59.6	0.0	11.3	96.3	2.4	17.2
Queue Length 95th (m)	4.4	46.0	2.2	42.2	92.2	6.1	20.1	121.7	6.6	25.1
Internal Link Dist (m)		1635.6			198.1			1951.8		1542.4
Turn Bay Length (m)	150.0		105.0	150.0		115.0	75.0		105.0	
Base Capacity (vph)	249	2685	811	348	1885	807	475	756	144	767
Starvation Cap Reductn	0	0	0	0	0	0	0	0	0	0
Spillback Cap Reductn	0	0	0	0	0	0	0	0	0	0
Storage Cap Reductn	0	0	0	0	0	0	0	0	0	0
Reduced v/c Ratio	0.04	0.26	0.02	0.40	0.45	0.05	0.13	0.59	0.08	0.10

Intersection Summary

Cycle Length: 120

Actuated Cycle Length: 120

Offset: 0 (0%), Referenced to phase 2:EBTL and 6:WBTL, Start of Green

Natural Cycle: 60

Control Type: Actuated-Coordinated

Splits and Phases: 3: Clarkway Drive/Humber Station Road & Mayfield Road

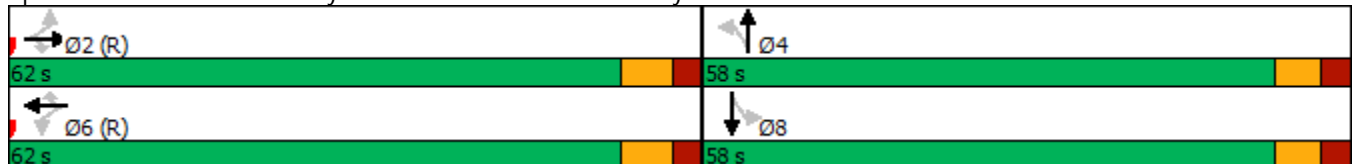

HCM Signalized Intersection Capacity Analysis
 3: Clarkway Drive/Humber Station Road & Mayfield Road

Future Background (2028) - Optimized
 PM Peak Hour



Movement	EBL	EBT	EBR	WBL	WBT	WBR	NBL	NBT	NBR	SBL	SBT	SBR
Lane Configurations	↘	↑↑↑	↗	↘	↑↑	↗	↘	↗		↘	↗	
Traffic Volume (vph)	10	688	19	135	828	42	59	270	161	11	65	12
Future Volume (vph)	10	688	19	135	828	42	59	270	161	11	65	12
Ideal Flow (vphpl)	1900	1900	1900	1900	1900	1900	1900	1900	1900	1900	1900	1900
Lane Width	3.0	3.5	3.0	3.0	3.5	3.0	3.0	3.5	3.0	3.0	3.5	3.0
Total Lost time (s)	7.3	7.3	7.3	7.3	7.3	7.3	7.0	7.0		7.0	7.0	
Lane Util. Factor	1.00	0.91	1.00	1.00	0.95	1.00	1.00	1.00		1.00	1.00	
Fr _t	1.00	1.00	0.85	1.00	1.00	0.85	1.00	0.94		1.00	0.98	
Fl _t Protected	0.95	1.00	1.00	0.95	1.00	1.00	0.95	1.00		0.95	1.00	
Satd. Flow (prot)	1404	4580	1358	1546	3216	1346	1504	1737		1546	1805	
Fl _t Permitted	0.29	1.00	1.00	0.36	1.00	1.00	0.71	1.00		0.21	1.00	
Satd. Flow (perm)	425	4580	1358	594	3216	1346	1117	1737		339	1805	
Peak-hour factor, PHF	0.97	0.97	0.97	0.97	0.97	0.97	0.97	0.97	0.97	0.97	0.97	0.97
Adj. Flow (vph)	10	709	20	139	854	43	61	278	166	11	67	12
RTOR Reduction (vph)	0	0	8	0	0	18	0	22	0	0	0	0
Lane Group Flow (vph)	10	709	12	139	854	25	61	422	0	11	79	0
Heavy Vehicles (%)	20%	12%	11%	9%	11%	12%	12%	1%	4%	9%	2%	0%
Turn Type	Perm	NA	Perm	Perm	NA	Perm	Perm	NA		Perm	NA	
Protected Phases		2			6			4			8	
Permitted Phases	2		2	6		6	4			8		
Actuated Green, G (s)	70.4	70.4	70.4	70.4	70.4	70.4	35.3	35.3		35.3	35.3	
Effective Green, g (s)	70.4	70.4	70.4	70.4	70.4	70.4	35.3	35.3		35.3	35.3	
Actuated g/C Ratio	0.59	0.59	0.59	0.59	0.59	0.59	0.29	0.29		0.29	0.29	
Clearance Time (s)	7.3	7.3	7.3	7.3	7.3	7.3	7.0	7.0		7.0	7.0	
Vehicle Extension (s)	3.0	3.0	3.0	3.0	3.0	3.0	3.0	3.0		3.0	3.0	
Lane Grp Cap (vph)	249	2686	796	348	1886	789	328	510		99	530	
v/s Ratio Prot		0.15			c0.27			c0.24			0.04	
v/s Ratio Perm	0.02		0.01	0.23		0.02	0.05			0.03		
v/c Ratio	0.04	0.26	0.01	0.40	0.45	0.03	0.19	0.83		0.11	0.15	
Uniform Delay, d ₁	10.5	12.1	10.3	13.4	14.0	10.4	31.6	39.5		30.9	31.3	
Progression Factor	1.00	1.00	1.00	1.00	1.00	1.00	1.00	1.00		0.97	1.00	
Incremental Delay, d ₂	0.3	0.2	0.0	3.4	0.8	0.1	0.3	10.6		0.5	0.1	
Delay (s)	10.8	12.4	10.4	16.8	14.7	10.5	31.9	50.1		30.5	31.3	
Level of Service	B	B	B	B	B	B	C	D		C	C	
Approach Delay (s)		12.3			14.8			47.9			31.2	
Approach LOS		B			B			D			C	

Intersection Summary		
HCM 2000 Control Delay	21.7	HCM 2000 Level of Service C
HCM 2000 Volume to Capacity ratio	0.58	
Actuated Cycle Length (s)	120.0	Sum of lost time (s) 14.3
Intersection Capacity Utilization	74.9%	ICU Level of Service D
Analysis Period (min)	15	

c Critical Lane Group

Queues
4: Coleraine Drive & Mayfield Road

Future Background (2028) - Optimized
PM Peak Hour



Lane Group	EBL	EBT	WBL	WBT	NBL	NBT	SBL	SBT
Lane Configurations	↖	↕	↖	↕	↖	↕	↖	↕
Traffic Volume (vph)	229	616	13	592	52	305	52	201
Future Volume (vph)	229	616	13	592	52	305	52	201
Lane Group Flow (vph)	241	679	14	706	55	343	55	486
Turn Type	pm+pt	NA	Perm	NA	Perm	NA	pm+pt	NA
Protected Phases	5	2		6		4	3	8
Permitted Phases	2		6		4		8	
Detector Phase	5	2	6	6	4	4	3	8
Switch Phase								
Minimum Initial (s)	5.0	12.0	12.0	12.0	12.0	12.0	5.0	12.0
Minimum Split (s)	8.0	37.0	37.0	37.0	37.0	37.0	8.0	37.0
Total Split (s)	12.0	80.0	68.0	68.0	36.0	36.0	14.0	50.0
Total Split (%)	9.2%	61.5%	52.3%	52.3%	27.7%	27.7%	10.8%	38.5%
Yellow Time (s)	3.0	4.6	4.6	4.6	4.2	4.2	3.0	4.2
All-Red Time (s)	0.0	2.4	2.4	2.4	2.8	2.8	0.0	2.8
Lost Time Adjust (s)	0.0	0.0	0.0	0.0	0.0	0.0	0.0	0.0
Total Lost Time (s)	3.0	7.0	7.0	7.0	7.0	7.0	3.0	7.0
Lead/Lag	Lead		Lag	Lag	Lag	Lag	Lead	
Lead-Lag Optimize?	Yes		Yes	Yes	Yes	Yes	Yes	
Recall Mode	None	C-Max	C-Max	C-Max	None	None	None	None
v/c Ratio	0.54	0.30	0.04	0.40	0.48	0.71	0.32	0.56
Control Delay	12.7	9.8	18.0	18.9	65.3	60.8	40.1	20.9
Queue Delay	0.0	0.0	0.0	0.0	0.0	0.0	0.0	0.0
Total Delay	12.7	9.8	18.0	18.9	65.3	60.8	40.1	20.9
Queue Length 50th (m)	22.1	37.7	1.8	57.0	13.9	46.5	11.5	25.9
Queue Length 95th (m)	39.6	55.3	6.1	82.6	27.7	61.0	21.6	41.1
Internal Link Dist (m)		290.4		1003.7		192.7		576.8
Turn Bay Length (m)	100.0		85.0		105.0		145.0	
Base Capacity (vph)	445	2269	356	1770	187	792	187	1187
Starvation Cap Reductn	0	0	0	0	0	0	0	0
Spillback Cap Reductn	0	0	0	0	0	0	0	0
Storage Cap Reductn	0	0	0	0	0	0	0	0
Reduced v/c Ratio	0.54	0.30	0.04	0.40	0.29	0.43	0.29	0.41

Intersection Summary

























Cycle Length: 130
 Actuated Cycle Length: 130
 Offset: 116 (89%), Referenced to phase 2:EBTL and 6:WBTL, Start of Green
 Natural Cycle: 90
 Control Type: Actuated-Coordinated

Splits and Phases: 4: Coleraine Drive & Mayfield Road



HCM Signalized Intersection Capacity Analysis
4: Coleraine Drive & Mayfield Road

Future Background (2028) - Optimized
PM Peak Hour

												
Movement	EBL	EBT	EBR	WBL	WBT	WBR	NBL	NBT	NBR	SBL	SBT	SBR
Lane Configurations		 			 			 			 	
Traffic Volume (vph)	229	616	29	13	592	79	52	305	21	52	201	260
Future Volume (vph)	229	616	29	13	592	79	52	305	21	52	201	260
Ideal Flow (vphpl)	1900	1900	1900	1900	1900	1900	1900	1900	1900	1900	1900	1900
Lane Width	3.0	3.5	3.0	3.0	3.5	3.0	3.0	3.5	3.0	3.0	3.5	3.0
Total Lost time (s)	3.0	7.0		7.0	7.0		7.0	7.0		3.0	7.0	
Lane Util. Factor	1.00	0.95		1.00	0.95		1.00	0.95		1.00	0.95	
Flt	1.00	0.99		1.00	0.98		1.00	0.99		1.00	0.92	
Flt Protected	0.95	1.00		0.95	1.00		0.95	1.00		0.95	1.00	
Satd. Flow (prot)	1440	3353		1560	3195		1685	3536		1348	3045	
Flt Permitted	0.33	1.00		0.39	1.00		0.48	1.00		0.32	1.00	
Satd. Flow (perm)	493	3353		646	3195		842	3536		456	3045	
Peak-hour factor, PHF	0.95	0.95	0.95	0.95	0.95	0.95	0.95	0.95	0.95	0.95	0.95	0.95
Adj. Flow (vph)	241	648	31	14	623	83	55	321	22	55	212	274
RTOR Reduction (vph)	0	2	0	0	7	0	0	4	0	0	211	0
Lane Group Flow (vph)	241	677	0	14	699	0	55	339	0	55	275	0
Heavy Vehicles (%)	17%	6%	0%	8%	8%	23%	0%	0%	0%	25%	0%	13%
Turn Type	pm+pt	NA		Perm	NA		Perm	NA		pm+pt	NA	
Protected Phases	5	2			6			4		3	8	
Permitted Phases	2			6			4			8		
Actuated Green, G (s)	87.4	87.4		71.3	71.3		17.7	17.7		28.6	28.6	
Effective Green, g (s)	87.4	87.4		71.3	71.3		17.7	17.7		28.6	28.6	
Actuated g/C Ratio	0.67	0.67		0.55	0.55		0.14	0.14		0.22	0.22	
Clearance Time (s)	3.0	7.0		7.0	7.0		7.0	7.0		3.0	7.0	
Vehicle Extension (s)	3.0	3.0		3.0	3.0		3.0	3.0		3.0	3.0	
Lane Grp Cap (vph)	426	2254		354	1752		114	481		154	669	
v/s Ratio Prot	c0.06	0.20			0.22			c0.10		0.02	c0.09	
v/s Ratio Perm	c0.32			0.02			0.07			0.06		
v/c Ratio	0.57	0.30		0.04	0.40		0.48	0.70		0.36	0.41	
Uniform Delay, d1	9.2	8.7		13.5	17.0		51.9	53.6		41.5	43.5	
Progression Factor	1.00	1.00		1.00	1.00		1.00	1.00		1.00	1.00	
Incremental Delay, d2	1.7	0.3		0.2	0.7		3.2	4.6		1.4	0.4	
Delay (s)	10.9	9.1		13.8	17.6		55.1	58.3		43.0	43.9	
Level of Service	B	A		B	B		E	E		D	D	
Approach Delay (s)		9.6			17.6			57.9			43.8	
Approach LOS		A			B			E			D	
Intersection Summary												
HCM 2000 Control Delay			26.4	HCM 2000 Level of Service				C				
HCM 2000 Volume to Capacity ratio			0.59									
Actuated Cycle Length (s)			130.0	Sum of lost time (s)				20.0				
Intersection Capacity Utilization			76.3%	ICU Level of Service				D				
Analysis Period (min)			15									

c Critical Lane Group

Queues

Future Background (2028) - Optimized

5: Coleraine Drive & Private Access/George Bolton Parkway

PM Peak Hour



Lane Group	EBL	EBT	WBL	WBT	NBL	NBT	SBL	SBT	SBR
Lane Configurations	↶	↷	↶	↷	↶	↷	↶	↷	↷
Traffic Volume (vph)	7	26	61	9	6	539	145	499	1
Future Volume (vph)	7	26	61	9	6	539	145	499	1
Lane Group Flow (vph)	8	58	73	198	7	733	175	601	1
Turn Type	Perm	NA	Perm	NA	Perm	NA	Perm	NA	Perm
Protected Phases		8		4		6		2	
Permitted Phases	8		4		6		2		2
Detector Phase	8	8	4	4	6	6	2	2	2
Switch Phase									
Minimum Initial (s)	8.0	8.0	12.0	12.0	12.0	12.0	12.0	12.0	12.0
Minimum Split (s)	32.5	32.5	32.5	32.5	34.2	34.2	33.7	33.7	33.7
Total Split (s)	45.0	45.0	45.0	45.0	55.0	55.0	55.0	55.0	55.0
Total Split (%)	45.0%	45.0%	45.0%	45.0%	55.0%	55.0%	55.0%	55.0%	55.0%
Yellow Time (s)	4.0	4.0	4.0	4.0	4.2	4.2	4.2	4.2	4.2
All-Red Time (s)	3.5	3.5	3.5	3.5	2.5	2.5	2.5	2.5	2.5
Lost Time Adjust (s)	0.0	0.0	0.0	0.0	0.0	0.0	0.0	0.0	0.0
Total Lost Time (s)	7.5	7.5	7.5	7.5	6.7	6.7	6.7	6.7	6.7
Lead/Lag									
Lead-Lag Optimize?									
Recall Mode	None	None	None	None	C-Max	C-Max	C-Max	C-Max	C-Max
v/c Ratio	0.07	0.24	0.48	0.54	0.02	0.33	0.39	0.26	0.00
Control Delay	37.4	25.7	50.0	12.8	4.8	5.6	8.9	5.3	0.0
Queue Delay	0.0	0.0	0.0	0.0	0.0	0.0	0.0	0.0	0.0
Total Delay	37.4	25.7	50.0	12.8	4.8	5.6	8.9	5.3	0.0
Queue Length 50th (m)	1.5	5.8	14.2	2.0	0.3	21.9	11.0	17.5	0.0
Queue Length 95th (m)	5.3	14.8	24.9	16.8	1.7	33.5	24.8	27.3	0.0
Internal Link Dist (m)		152.4		468.8		784.9		1711.9	
Turn Bay Length (m)	70.0		105.0		75.0		100.0		100.0
Base Capacity (vph)	322	619	423	675	362	2244	449	2280	1101
Starvation Cap Reductn	0	0	0	0	0	0	0	0	0
Spillback Cap Reductn	0	0	0	0	0	0	0	0	0
Storage Cap Reductn	0	0	0	0	0	0	0	0	0
Reduced v/c Ratio	0.02	0.09	0.17	0.29	0.02	0.33	0.39	0.26	0.00

Intersection Summary

Cycle Length: 100
 Actuated Cycle Length: 100
 Offset: 0 (0%), Referenced to phase 2:SBTL and 6:NBTL, Start of Green
 Natural Cycle: 70
 Control Type: Actuated-Coordinated

Splits and Phases: 5: Coleraine Drive & Private Access/George Bolton Parkway

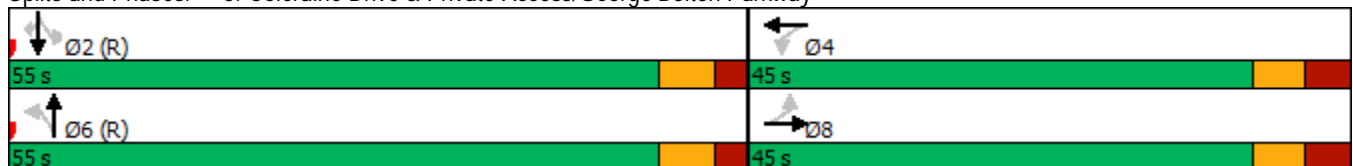

HCM Signalized Intersection Capacity Analysis

Future Background (2028) - Optimized

5: Coleraine Drive & Private Access/George Bolton Parkway

PM Peak Hour



Movement	EBL	EBT	EBR	WBL	WBT	WBR	NBL	NBT	NBR	SBL	SBT	SBR
Lane Configurations	↖	↗		↖	↗		↖	↕		↖	↗	↖
Traffic Volume (vph)	7	26	22	61	9	155	6	539	70	145	499	1
Future Volume (vph)	7	26	22	61	9	155	6	539	70	145	499	1
Ideal Flow (vphpl)	1900	1900	1900	1900	1900	1900	1900	1900	1900	1900	1900	1900
Lane Width	3.0	3.5	3.0	3.0	3.5	3.0	3.0	3.5	3.0	3.0	3.5	3.0
Total Lost time (s)	7.5	7.5		7.5	7.5		6.7	6.7		6.7	6.7	6.7
Lane Util. Factor	1.00	1.00		1.00	1.00		1.00	0.95		1.00	0.95	1.00
Flt Protected	1.00	0.93		1.00	0.86		1.00	0.98		1.00	1.00	0.85
Flt Permitted	0.95	1.00		0.95	1.00		0.95	1.00		0.95	1.00	1.00
Satd. Flow (prot)	1685	1608		1491	1491		1123	3102		1604	3159	1507
Satd. Flow (perm)	861	1608		1129	1491		502	3102		623	3159	1507
Peak-hour factor, PHF	0.83	0.83	0.83	0.83	0.83	0.83	0.83	0.83	0.83	0.83	0.83	0.83
Adj. Flow (vph)	8	31	27	73	11	187	7	649	84	175	601	1
RTOR Reduction (vph)	0	23	0	0	162	0	0	5	0	0	0	0
Lane Group Flow (vph)	8	35	0	73	36	0	7	728	0	175	601	1
Heavy Vehicles (%)	0%	4%	14%	13%	11%	8%	50%	13%	14%	5%	13%	0%
Turn Type	Perm	NA		Perm	NA		Perm	NA		Perm	NA	Perm
Protected Phases		8			4			6			2	
Permitted Phases	8			4			6			2		2
Actuated Green, G (s)	13.6	13.6		13.6	13.6		72.2	72.2		72.2	72.2	72.2
Effective Green, g (s)	13.6	13.6		13.6	13.6		72.2	72.2		72.2	72.2	72.2
Actuated g/C Ratio	0.14	0.14		0.14	0.14		0.72	0.72		0.72	0.72	0.72
Clearance Time (s)	7.5	7.5		7.5	7.5		6.7	6.7		6.7	6.7	6.7
Vehicle Extension (s)	3.0	3.0		3.0	3.0		3.0	3.0		3.0	3.0	3.0
Lane Grp Cap (vph)	117	218		153	202		362	2239		449	2280	1088
v/s Ratio Prot		0.02			0.02			0.23			0.19	
v/s Ratio Perm	0.01			c0.06			0.01			c0.28		0.00
v/c Ratio	0.07	0.16		0.48	0.18		0.02	0.33		0.39	0.26	0.00
Uniform Delay, d1	37.7	38.1		39.9	38.3		3.9	5.0		5.4	4.8	3.9
Progression Factor	1.00	1.00		1.00	1.00		1.00	1.00		1.00	1.00	1.00
Incremental Delay, d2	0.2	0.3		2.3	0.4		0.1	0.4		2.5	0.3	0.0
Delay (s)	37.9	38.5		42.3	38.7		4.0	5.4		7.9	5.1	3.9
Level of Service	D	D		D	D		A	A		A	A	A
Approach Delay (s)		38.4			39.7			5.4			5.7	
Approach LOS		D			D			A			A	

Intersection Summary

HCM 2000 Control Delay	11.7	HCM 2000 Level of Service	B
HCM 2000 Volume to Capacity ratio	0.40		
Actuated Cycle Length (s)	100.0	Sum of lost time (s)	14.2
Intersection Capacity Utilization	54.6%	ICU Level of Service	A
Analysis Period (min)	15		

c Critical Lane Group

Queues
6: Highway 50 & George Bolton Parkway/Private Access

Future Background (2028) - Optimized
PM Peak Hour



Lane Group	EBL	EBT	WBT	NBL	NBT	SBL	SBT	SBR
Lane Configurations								
Traffic Volume (vph)	209	0	0	135	1320	1	983	169
Future Volume (vph)	209	0	0	135	1320	1	983	169
Lane Group Flow (vph)	218	201	7	141	1375	1	1024	176
Turn Type	Perm	NA	NA	pm+pt	NA	Perm	NA	Perm
Protected Phases		8	4	1	6		2	
Permitted Phases	8			6		2		2
Detector Phase	8	8	4	1	6	2	2	2
Switch Phase								
Minimum Initial (s)	8.0	8.0	8.0	5.0	12.0	12.0	12.0	12.0
Minimum Split (s)	32.6	32.6	32.6	8.0	27.3	27.3	27.3	27.3
Total Split (s)	35.0	35.0	35.0	10.0	85.0	75.0	75.0	75.0
Total Split (%)	29.2%	29.2%	29.2%	8.3%	70.8%	62.5%	62.5%	62.5%
Yellow Time (s)	4.0	4.0	4.0	3.0	4.0	4.0	4.0	4.0
All-Red Time (s)	2.6	2.6	2.6	0.0	2.3	2.3	2.3	2.3
Lost Time Adjust (s)	0.0	0.0	0.0	0.0	0.0	0.0	0.0	0.0
Total Lost Time (s)	6.6	6.6	6.6	3.0	6.3	6.3	6.3	6.3
Lead/Lag				Lead		Lag	Lag	Lag
Lead-Lag Optimize?				Yes		Yes	Yes	Yes
Recall Mode	None	None	None	None	C-Max	C-Max	C-Max	C-Max
v/c Ratio	0.83	0.47	0.02	0.47	0.58	0.01	0.49	0.19
Control Delay	70.6	9.8	0.1	11.1	11.3	11.0	14.8	2.2
Queue Delay	0.0	0.0	0.0	0.0	0.0	0.0	0.0	0.0
Total Delay	70.6	9.8	0.1	11.1	11.3	11.0	14.8	2.2
Queue Length 50th (m)	51.6	1.6	0.0	9.9	85.7	0.1	75.0	0.0
Queue Length 95th (m)	#78.9	21.6	0.0	18.9	116.1	0.9	94.9	9.7
Internal Link Dist (m)		846.5	43.0		1045.6		1307.8	
Turn Bay Length (m)	85.0			40.0		135.0		60.0
Base Capacity (vph)	315	479	434	301	2362	189	2103	945
Starvation Cap Reductn	0	0	0	0	0	0	0	0
Spillback Cap Reductn	0	0	0	0	0	0	0	0
Storage Cap Reductn	0	0	0	0	0	0	0	0
Reduced v/c Ratio	0.69	0.42	0.02	0.47	0.58	0.01	0.49	0.19

Intersection Summary





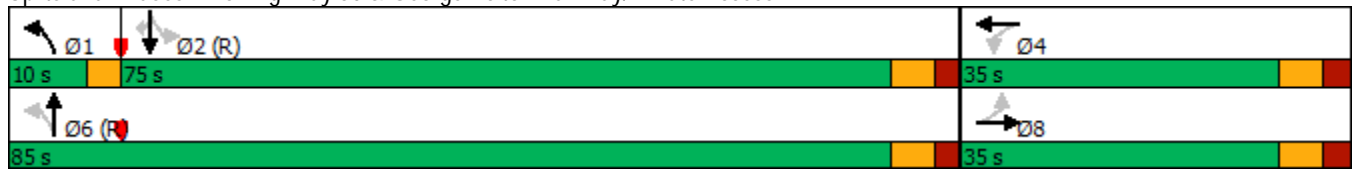















Cycle Length: 120
 Actuated Cycle Length: 120
 Offset: 116 (97%), Referenced to phase 2:SBTL and 6:NBTL, Start of Green
 Natural Cycle: 70
 Control Type: Actuated-Coordinated
 # 95th percentile volume exceeds capacity, queue may be longer.
 Queue shown is maximum after two cycles.

Splits and Phases: 6: Highway 50 & George Bolton Parkway/Private Access



HCM Signalized Intersection Capacity Analysis
6: Highway 50 & George Bolton Parkway/Private Access

Future Background (2028) - Optimized
PM Peak Hour

													
Movement	EBL	EBT	EBR	WBL	WBT	WBR	NBL	NBT	NBR	SBL	SBT	SBR	
Lane Configurations													
Traffic Volume (vph)	209	0	193	0	0	7	135	1320	0	1	983	169	
Future Volume (vph)	209	0	193	0	0	7	135	1320	0	1	983	169	
Ideal Flow (vphpl)	1900	1900	1900	1900	1900	1900	1900	1900	1900	1900	1900	1900	
Lane Width	3.0	3.5	3.0	3.0	3.5	3.0	3.0	3.5	3.0	3.0	3.5	3.0	
Total Lost time (s)	6.6	6.6			6.6		3.0	6.3		6.3	6.3	6.3	
Lane Util. Factor	1.00	1.00			1.00		1.00	0.95		1.00	0.95	1.00	
Frbp, ped/bikes	1.00	0.99			1.00		1.00	1.00		1.00	1.00	0.98	
Flpb, ped/bikes	1.00	1.00			1.00		1.00	1.00		1.00	1.00	1.00	
Frt	1.00	0.85			0.86		1.00	1.00		1.00	1.00	0.85	
Flt Protected	0.95	1.00			1.00		0.95	1.00		0.95	1.00	1.00	
Satd. Flow (prot)	1685	1405			1625		1404	3400		1685	3466	1444	
Flt Permitted	0.75	1.00			1.00		0.22	1.00		0.18	1.00	1.00	
Satd. Flow (perm)	1336	1405			1625		321	3400		312	3466	1444	
Peak-hour factor, PHF	0.96	0.96	0.96	0.96	0.96	0.96	0.96	0.96	0.96	0.96	0.96	0.96	
Adj. Flow (vph)	218	0	201	0	0	7	141	1375	0	1	1024	176	
RTOR Reduction (vph)	0	155	0	0	6	0	0	0	0	0	0	69	
Lane Group Flow (vph)	218	46	0	0	1	0	141	1375	0	1	1024	107	
Confl. Peds. (#/hr)			2	2			1					1	
Heavy Vehicles (%)	0%	0%	12%	0%	0%	0%	20%	5%	0%	0%	3%	2%	
Turn Type	Perm	NA			NA		pm+pt	NA		Perm	NA	Perm	
Protected Phases		8			4		1	6			2		
Permitted Phases	8			4			6			2		2	
Actuated Green, G (s)	23.7	23.7			23.7		83.4	83.4		72.8	72.8	72.8	
Effective Green, g (s)	23.7	23.7			23.7		83.4	83.4		72.8	72.8	72.8	
Actuated g/C Ratio	0.20	0.20			0.20		0.70	0.70		0.61	0.61	0.61	
Clearance Time (s)	6.6	6.6			6.6		3.0	6.3		6.3	6.3	6.3	
Vehicle Extension (s)	3.0	3.0			3.0		3.0	3.0		3.0	3.0	3.0	
Lane Grp Cap (vph)	263	277			320		291	2363		189	2102	876	
v/s Ratio Prot		0.03			0.00		0.03	c0.40			0.30		
v/s Ratio Perm	c0.16						0.30			0.00		0.07	
v/c Ratio	0.83	0.17			0.00		0.48	0.58		0.01	0.49	0.12	
Uniform Delay, d1	46.2	40.0			38.7		8.0	9.4		9.3	13.2	10.0	
Progression Factor	1.00	1.00			1.00		1.00	1.00		1.00	1.00	1.00	
Incremental Delay, d2	18.9	0.3			0.0		1.3	1.1		0.1	0.8	0.3	
Delay (s)	65.1	40.2			38.7		9.3	10.4		9.4	14.0	10.3	
Level of Service	E	D			D		A	B		A	B	B	
Approach Delay (s)		53.2			38.7			10.3			13.4		
Approach LOS		D			D			B			B		
Intersection Summary													
HCM 2000 Control Delay			17.3				HCM 2000 Level of Service				B		
HCM 2000 Volume to Capacity ratio			0.65										
Actuated Cycle Length (s)			120.0				Sum of lost time (s)			15.9			
Intersection Capacity Utilization			81.0%				ICU Level of Service			D			
Analysis Period (min)			15										
c Critical Lane Group													

HCM Unsignalized Intersection Capacity Analysis
 9: Humber Station Road & Subject Lands Site Access 1

Future Background (2028) - Optimized
 PM Peak Hour



Movement	WBL	WBR	NBT	NBR	SBL	SBT
Lane Configurations						
Traffic Volume (veh/h)	0	0	322	0	0	88
Future Volume (Veh/h)	0	0	322	0	0	88
Sign Control	Stop		Free		Free	
Grade	0%		0%		0%	
Peak Hour Factor	1.00	1.00	1.00	1.00	1.00	1.00
Hourly flow rate (vph)	0	0	322	0	0	88
Pedestrians						
Lane Width (m)						
Walking Speed (m/s)						
Percent Blockage						
Right turn flare (veh)						
Median type	None			None		
Median storage (veh)						
Upstream signal (m)						
pX, platoon unblocked						
vC, conflicting volume	410	322			322	
vC1, stage 1 conf vol						
vC2, stage 2 conf vol						
vCu, unblocked vol	410	322			322	
tC, single (s)	6.4	6.2			4.1	
tC, 2 stage (s)						
tF (s)	3.5	3.3			2.2	
p0 queue free %	100	100			100	
cM capacity (veh/h)	602	724			1249	
Direction, Lane #	WB 1	WB 2	NB 1	NB 2	SB 1	SB 2
Volume Total	0	0	322	0	0	88
Volume Left	0	0	0	0	0	0
Volume Right	0	0	0	0	0	0
cSH	1700	1700	1700	1700	1700	1700
Volume to Capacity	0.00	0.00	0.19	0.00	0.00	0.05
Queue Length 95th (m)	0.0	0.0	0.0	0.0	0.0	0.0
Control Delay (s)	0.0	0.0	0.0	0.0	0.0	0.0
Lane LOS	A	A				
Approach Delay (s)	0.0		0.0		0.0	
Approach LOS	A					
Intersection Summary						
Average Delay			0.0			
Intersection Capacity Utilization			20.3%	ICU Level of Service	A	
Analysis Period (min)			15			

HCM Unsignalized Intersection Capacity Analysis
 24: Mayfield Road & Triangle Lands

Future Background (2028) - Optimized
 PM Peak Hour



Movement	EBL	EBT	WBT	WBR	SBL	SBR	
Lane Configurations							
Traffic Volume (veh/h)	85	775	838	57	75	167	
Future Volume (Veh/h)	85	775	838	57	75	167	
Sign Control		Free	Free		Stop		
Grade		0%	0%		0%		
Peak Hour Factor	1.00	1.00	1.00	1.00	1.00	1.00	
Hourly flow rate (vph)	85	775	838	57	75	167	
Pedestrians							
Lane Width (m)							
Walking Speed (m/s)							
Percent Blockage							
Right turn flare (veh)							
Median type		None	None				
Median storage (veh)							
Upstream signal (m)			314				
pX, platoon unblocked	0.91				0.91	0.91	
vC, conflicting volume	895				1424	448	
vC1, stage 1 conf vol							
vC2, stage 2 conf vol							
vCu, unblocked vol	675				1259	180	
tC, single (s)	4.4				7.1	7.2	
tC, 2 stage (s)							
tF (s)	2.3				3.6	3.4	
p0 queue free %	89				36	77	
cM capacity (veh/h)	757				117	720	
Direction, Lane #	EB 1	EB 2	EB 3	WB 1	WB 2	SB 1	SB 2
Volume Total	85	388	388	559	336	75	167
Volume Left	85	0	0	0	0	75	0
Volume Right	0	0	0	0	57	0	167
cSH	757	1700	1700	1700	1700	117	720
Volume to Capacity	0.11	0.23	0.23	0.33	0.20	0.64	0.23
Queue Length 95th (m)	3.0	0.0	0.0	0.0	0.0	26.3	7.2
Control Delay (s)	10.4	0.0	0.0	0.0	0.0	78.9	11.5
Lane LOS	B					F	B
Approach Delay (s)	1.0			0.0		32.4	
Approach LOS						D	
Intersection Summary							
Average Delay			4.4				
Intersection Capacity Utilization			43.8%		ICU Level of Service		A
Analysis Period (min)			15				

Queues
1: Coleraine Drive & Healey Road

Future Background (2033) - Optimized
AM Peak Hour



Lane Group	EBL	EBT	WBL	WBT	NBL	NBT	SBL	SBT
Lane Configurations	↶	↷	↶	↷	↶	↷	↶	↷
Traffic Volume (vph)	162	397	49	149	35	142	64	324
Future Volume (vph)	162	397	49	149	35	142	64	324
Lane Group Flow (vph)	174	687	53	184	38	182	69	522
Turn Type	pm+pt	NA	Perm	NA	pm+pt	NA	Perm	NA
Protected Phases	3	8		4	1	6		2
Permitted Phases	8		4		6		2	
Detector Phase	3	8	4	4	1	6	2	2
Switch Phase								
Minimum Initial (s)	5.0	8.0	8.0	8.0	5.0	8.0	8.0	8.0
Minimum Split (s)	9.5	32.8	32.8	32.8	9.5	36.7	36.7	36.7
Total Split (s)	10.0	71.0	61.0	61.0	10.0	49.0	39.0	39.0
Total Split (%)	8.3%	59.2%	50.8%	50.8%	8.3%	40.8%	32.5%	32.5%
Yellow Time (s)	3.0	4.0	4.0	4.0	3.0	4.6	4.6	4.6
All-Red Time (s)	0.0	2.8	2.8	2.8	0.0	2.1	2.1	2.1
Lost Time Adjust (s)	0.0	0.0	0.0	0.0	0.0	0.0	0.0	0.0
Total Lost Time (s)	3.0	6.8	6.8	6.8	3.0	6.7	6.7	6.7
Lead/Lag	Lead		Lag	Lag	Lead		Lag	Lag
Lead-Lag Optimize?	Yes		Yes	Yes	Yes		Yes	Yes
Recall Mode	None	None	None	None	None	C-Max	C-Max	C-Max
v/c Ratio	0.33	0.85	0.52	0.30	0.11	0.16	0.20	0.43
Control Delay	16.8	36.7	47.0	25.3	21.7	20.7	32.5	27.4
Queue Delay	0.0	0.0	0.0	0.0	0.0	0.0	0.0	0.0
Total Delay	16.8	36.7	47.0	25.3	21.7	20.7	32.5	27.4
Queue Length 50th (m)	31.2	173.9	10.0	30.0	5.2	12.7	12.1	45.8
Queue Length 95th (m)	m29.9	m209.8	23.3	42.4	13.5	23.5	27.7	70.5
Internal Link Dist (m)		823.7		424.0		1711.9		1121.0
Turn Bay Length (m)	55.0		50.0		80.0		155.0	
Base Capacity (vph)	522	947	124	756	353	1164	338	1212
Starvation Cap Reductn	0	0	0	0	0	0	0	0
Spillback Cap Reductn	0	0	0	0	0	0	0	0
Storage Cap Reductn	0	0	0	0	0	0	0	0
Reduced v/c Ratio	0.33	0.73	0.43	0.24	0.11	0.16	0.20	0.43

Intersection Summary





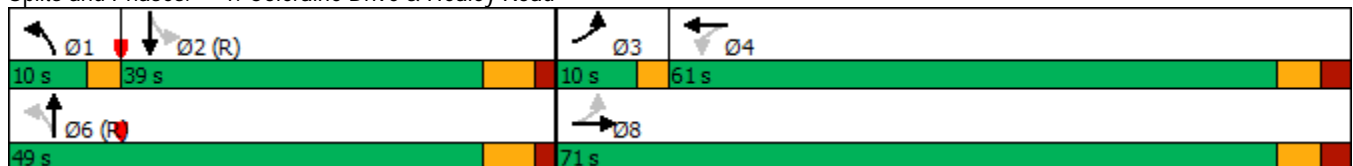

















Cycle Length: 120
 Actuated Cycle Length: 120
 Offset: 0 (0%), Referenced to phase 2:SBTL and 6:NBTL, Start of Green
 Natural Cycle: 90
 Control Type: Actuated-Coordinated
 m Volume for 95th percentile queue is metered by upstream signal.

Splits and Phases: 1: Coleraine Drive & Healey Road



HCM Signalized Intersection Capacity Analysis
1: Coleraine Drive & Healey Road

Future Background (2033) - Optimized
AM Peak Hour

												
Movement	EBL	EBT	EBR	WBL	WBT	WBR	NBL	NBT	NBR	SBL	SBT	SBR
Lane Configurations												
Traffic Volume (vph)	162	397	242	49	149	22	35	142	27	64	324	162
Future Volume (vph)	162	397	242	49	149	22	35	142	27	64	324	162
Ideal Flow (vphpl)	1900	1900	1900	1900	1900	1900	1900	1900	1900	1900	1900	1900
Lane Width	3.0	3.5	3.0	3.0	3.5	3.0	3.0	3.5	3.0	3.0	3.5	3.0
Total Lost time (s)	3.0	6.8		6.8	6.8		3.0	6.7		6.7	6.7	
Lane Util. Factor	1.00	1.00		1.00	1.00		1.00	0.95		1.00	0.95	
Flt	1.00	0.94		1.00	0.98		1.00	0.98		1.00	0.95	
Flt Protected	0.95	1.00		0.95	1.00		0.95	1.00		0.95	1.00	
Satd. Flow (prot)	1652	1737		1404	1665		1636	2648		1316	3046	
Flt Permitted	0.58	1.00		0.19	1.00		0.36	1.00		0.64	1.00	
Satd. Flow (perm)	1001	1737		275	1665		628	2648		883	3046	
Peak-hour factor, PHF	0.93	0.93	0.93	0.93	0.93	0.93	0.93	0.93	0.93	0.93	0.93	0.93
Adj. Flow (vph)	174	427	260	53	160	24	38	153	29	69	348	174
RTOR Reduction (vph)	0	21	0	0	5	0	0	11	0	0	44	0
Lane Group Flow (vph)	174	666	0	53	179	0	38	171	0	69	478	0
Heavy Vehicles (%)	2%	2%	2%	20%	2%	68%	3%	34%	19%	28%	16%	2%
Turn Type	pm+pt	NA		Perm	NA		pm+pt	NA		Perm	NA	
Protected Phases	3	8			4		1	6			2	
Permitted Phases	8			4			6			2		
Actuated Green, G (s)	54.2	54.2		44.2	44.2		52.3	52.3		44.9	44.9	
Effective Green, g (s)	54.2	54.2		44.2	44.2		52.3	52.3		44.9	44.9	
Actuated g/C Ratio	0.45	0.45		0.37	0.37		0.44	0.44		0.37	0.37	
Clearance Time (s)	3.0	6.8		6.8	6.8		3.0	6.7		6.7	6.7	
Vehicle Extension (s)	3.0	3.0		3.0	3.0		3.0	3.0		3.0	3.0	
Lane Grp Cap (vph)	490	784		101	613		310	1154		330	1139	
v/s Ratio Prot	0.02	c0.38			0.11		0.00	c0.06			c0.16	
v/s Ratio Perm	0.14			0.19			0.05			0.08		
v/c Ratio	0.36	0.85		0.52	0.29		0.12	0.15		0.21	0.42	
Uniform Delay, d1	20.6	29.3		29.7	26.8		20.0	20.4		25.5	27.9	
Progression Factor	0.93	1.07		1.00	1.00		1.00	1.00		1.00	1.00	
Incremental Delay, d2	0.3	6.1		4.8	0.3		0.2	0.3		1.4	1.1	
Delay (s)	19.5	37.5		34.5	27.1		20.2	20.7		26.9	29.0	
Level of Service	B	D		C	C		C	C		C	C	
Approach Delay (s)		33.9			28.8			20.6			28.8	
Approach LOS		C			C			C			C	
Intersection Summary												
HCM 2000 Control Delay			30.1				HCM 2000 Level of Service				C	
HCM 2000 Volume to Capacity ratio			0.65									
Actuated Cycle Length (s)			120.0				Sum of lost time (s)			19.5		
Intersection Capacity Utilization			80.9%				ICU Level of Service			D		
Analysis Period (min)			15									

c Critical Lane Group

Queues
2: Humber Station Road & Healey Road

Future Background (2033) - Optimized
AM Peak Hour

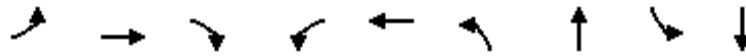

Lane Group	EBL	EBT	EBR	WBL	WBT	NBL	NBT	SBL	SBT
Lane Configurations	↖	↑	↗	↖	↗	↖	↗	↖	↗
Traffic Volume (vph)	4	708	35	73	320	23	20	79	183
Future Volume (vph)	4	708	35	73	320	23	20	79	183
Lane Group Flow (vph)	4	761	38	78	348	25	63	85	201
Turn Type	Perm	NA	Perm	pm+pt	NA	Perm	NA	Perm	NA
Protected Phases		4		3	8		2		6
Permitted Phases	4		4	8		2		6	
Detector Phase	4	4	4	3	8	2	2	6	6
Switch Phase									
Minimum Initial (s)	8.0	8.0	8.0	5.0	8.0	8.0	8.0	5.0	5.0
Minimum Split (s)	24.8	24.8	24.8	9.5	24.8	24.7	24.7	24.8	24.8
Total Split (s)	65.0	65.0	65.0	25.0	90.0	30.0	30.0	30.0	30.0
Total Split (%)	54.2%	54.2%	54.2%	20.8%	75.0%	25.0%	25.0%	25.0%	25.0%
Yellow Time (s)	4.0	4.0	4.0	3.0	4.0	4.6	4.6	4.6	4.6
All-Red Time (s)	2.8	2.8	2.8	0.0	2.8	2.1	2.1	2.1	2.1
Lost Time Adjust (s)	0.0	0.0	0.0	0.0	0.0	0.0	0.0	0.0	0.0
Total Lost Time (s)	6.8	6.8	6.8	3.0	6.8	6.7	6.7	6.7	6.7
Lead/Lag	Lag	Lag	Lag	Lead					
Lead-Lag Optimize?	Yes	Yes	Yes	Yes					
Recall Mode	None	None	None	None	None	C-Max	C-Max	C-Max	C-Max
v/c Ratio	0.01	0.90	0.05	0.41	0.36	0.07	0.10	0.19	0.31
Control Delay	15.0	43.7	1.6	18.9	13.0	32.3	16.1	32.1	32.5
Queue Delay	0.0	0.0	0.0	0.0	0.0	0.0	0.0	0.0	0.0
Total Delay	15.0	43.7	1.6	18.9	13.0	32.3	16.1	32.1	32.5
Queue Length 50th (m)	0.5	165.0	0.0	8.1	41.7	5.3	5.8	15.3	37.6
Queue Length 95th (m)	2.4	207.2	2.8	19.1	52.0	14.3	19.8	30.9	63.3
Internal Link Dist (m)		465.5			505.1		463.9		452.2
Turn Bay Length (m)	30.0		30.0	60.0		30.0		30.0	
Base Capacity (vph)	385	907	751	369	1271	335	613	448	655
Starvation Cap Reductn	0	0	0	0	0	0	0	0	0
Spillback Cap Reductn	0	0	0	0	0	0	0	0	0
Storage Cap Reductn	0	0	0	0	0	0	0	0	0
Reduced v/c Ratio	0.01	0.84	0.05	0.21	0.27	0.07	0.10	0.19	0.31

Intersection Summary

Cycle Length: 120
 Actuated Cycle Length: 120
 Offset: 0 (0%), Referenced to phase 2:NBTL and 6:SBTL, Start of Green
 Natural Cycle: 75
 Control Type: Actuated-Coordinated



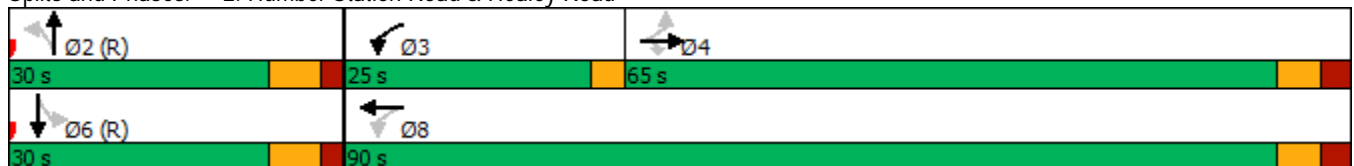

















Splits and Phases: 2: Humber Station Road & Healey Road



HCM Signalized Intersection Capacity Analysis

2: Humber Station Road & Healey Road

Future Background (2033) - Optimized
AM Peak Hour

												
Movement	EBL	EBT	EBR	WBL	WBT	WBR	NBL	NBT	NBR	SBL	SBT	SBR
Lane Configurations												
Traffic Volume (vph)	4	708	35	73	320	4	23	20	38	79	183	4
Future Volume (vph)	4	708	35	73	320	4	23	20	38	79	183	4
Ideal Flow (vphpl)	1900	1900	1900	1900	1900	1900	1900	1900	1900	1900	1900	1900
Lane Width	3.0	3.5	3.0	3.0	3.5	3.0	3.0	3.5	3.0	3.0	3.5	3.0
Total Lost time (s)	6.8	6.8	6.8	3.0	6.8		6.7	6.7		6.7	6.7	
Lane Util. Factor	1.00	1.00	1.00	1.00	1.00		1.00	1.00		1.00	1.00	
Fr _t	1.00	1.00	0.85	1.00	1.00		1.00	0.90		1.00	1.00	
Fl _t Protected	0.95	1.00	1.00	0.95	1.00		0.95	1.00		0.95	1.00	
Satd. Flow (prot)	1348	1842	1463	1668	1834		1546	1663		1685	1855	
Fl _t Permitted	0.55	1.00	1.00	0.10	1.00		0.58	1.00		0.72	1.00	
Satd. Flow (perm)	783	1842	1463	167	1834		951	1663		1270	1855	
Peak-hour factor, PHF	0.93	0.93	0.93	0.93	0.93	0.93	0.93	0.93	0.93	0.93	0.93	0.93
Adj. Flow (vph)	4	761	38	78	344	4	25	22	41	85	197	4
RTOR Reduction (vph)	0	0	20	0	0	0	0	27	0	0	1	0
Lane Group Flow (vph)	4	761	18	78	348	0	25	36	0	85	200	0
Heavy Vehicles (%)	25%	2%	3%	1%	2%	25%	9%	0%	3%	0%	1%	0%
Turn Type	Perm	NA	Perm	pm+pt	NA		Perm	NA		Perm	NA	
Protected Phases		4		3	8			2			6	
Permitted Phases	4		4	8			2			6		
Actuated Green, G (s)	55.3	55.3	55.3	64.7	64.7		41.8	41.8		41.8	41.8	
Effective Green, g (s)	55.3	55.3	55.3	64.7	64.7		41.8	41.8		41.8	41.8	
Actuated g/C Ratio	0.46	0.46	0.46	0.54	0.54		0.35	0.35		0.35	0.35	
Clearance Time (s)	6.8	6.8	6.8	3.0	6.8		6.7	6.7		6.7	6.7	
Vehicle Extension (s)	3.0	3.0	3.0	3.0	3.0		3.0	3.0		3.0	3.0	
Lane Grp Cap (vph)	360	848	674	170	988		331	579		442	646	
v/s Ratio Prot		c0.41		c0.02	0.19			0.02			c0.11	
v/s Ratio Perm	0.01		0.01	0.22			0.03			0.07		
v/c Ratio	0.01	0.90	0.03	0.46	0.35		0.08	0.06		0.19	0.31	
Uniform Delay, d ₁	17.5	29.7	17.7	22.3	15.7		26.2	26.0		27.3	28.6	
Progression Factor	1.00	1.00	1.00	1.26	0.80		1.03	1.09		1.00	1.00	
Incremental Delay, d ₂	0.0	12.1	0.0	1.9	0.2		0.4	0.2		1.0	1.2	
Delay (s)	17.5	41.9	17.7	30.1	12.8		27.3	28.6		28.3	29.8	
Level of Service	B	D	B	C	B		C	C		C	C	
Approach Delay (s)		40.6			16.0			28.2			29.4	
Approach LOS		D			B			C			C	
Intersection Summary												
HCM 2000 Control Delay			31.4	HCM 2000 Level of Service				C				
HCM 2000 Volume to Capacity ratio			0.63									
Actuated Cycle Length (s)			120.0	Sum of lost time (s)				16.5				
Intersection Capacity Utilization			75.1%	ICU Level of Service				D				
Analysis Period (min)			15									

c Critical Lane Group

Queues

3: Clarkway Drive/Humber Station Road & Mayfield Road

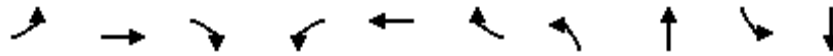

Lane Group	EBL	EBT	EBR	WBL	WBT	WBR	NBL	NBT	SBL	SBT
Lane Configurations	↖	↑↑↑	↗	↖	↑↑	↗	↖	↗	↖	↗
Traffic Volume (vph)	8	848	28	102	623	21	11	57	23	272
Future Volume (vph)	8	848	28	102	623	21	11	57	23	272
Lane Group Flow (vph)	8	883	29	106	649	22	11	280	24	291
Turn Type	pm+pt	NA	Perm	Perm	NA	Perm	Perm	NA	Perm	NA
Protected Phases	5	2			6			4		8
Permitted Phases	2		2	6		6	4		8	
Detector Phase	5	2	2	6	6	6	4	4	8	8
Switch Phase										
Minimum Initial (s)	5.0	12.0	12.0	12.0	12.0	12.0	8.0	8.0	8.0	8.0
Minimum Split (s)	9.5	27.3	27.3	27.5	27.5	27.5	26.0	26.0	27.5	27.5
Total Split (s)	20.0	70.0	70.0	50.0	50.0	50.0	50.0	50.0	50.0	50.0
Total Split (%)	16.7%	58.3%	58.3%	41.7%	41.7%	41.7%	41.7%	41.7%	41.7%	41.7%
Yellow Time (s)	3.0	4.6	4.6	4.6	4.6	4.6	4.2	4.2	4.2	4.2
All-Red Time (s)	0.0	2.7	2.7	2.7	2.7	2.7	2.8	2.8	2.8	2.8
Lost Time Adjust (s)	0.0	0.0	0.0	0.0	0.0	0.0	0.0	0.0	0.0	0.0
Total Lost Time (s)	3.0	7.3	7.3	7.3	7.3	7.3	7.0	7.0	7.0	7.0
Lead/Lag	Lead			Lag	Lag	Lag				
Lead-Lag Optimize?	Yes			Yes	Yes	Yes				
Recall Mode	None	C-Max	C-Max	C-Max	C-Max	C-Max	None	None	None	None
v/c Ratio	0.02	0.29	0.04	0.31	0.32	0.02	0.12	0.67	0.22	0.77
Control Delay	6.8	8.7	2.3	14.4	10.5	0.0	38.7	32.5	41.9	59.0
Queue Delay	0.0	0.0	0.0	0.0	0.0	0.0	0.0	0.0	0.0	0.0
Total Delay	6.8	8.7	2.3	14.4	10.5	0.0	38.7	32.5	41.9	59.0
Queue Length 50th (m)	0.5	29.3	0.0	9.7	31.4	0.0	2.3	37.5	5.7	75.3
Queue Length 95th (m)	2.5	44.5	3.2	30.5	62.2	0.0	7.3	63.0	14.8	102.6
Internal Link Dist (m)		1635.6			201.2			1951.8		1542.4
Turn Bay Length (m)	150.0		105.0	150.0		115.0	75.0		105.0	
Base Capacity (vph)	548	3047	828	340	2036	928	166	648	193	664
Starvation Cap Reductn	0	0	0	0	0	0	0	0	0	0
Spillback Cap Reductn	0	0	0	0	0	0	0	0	0	0
Storage Cap Reductn	0	0	0	0	0	0	0	0	0	0
Reduced v/c Ratio	0.01	0.29	0.04	0.31	0.32	0.02	0.07	0.43	0.12	0.44

Intersection Summary

Cycle Length: 120
 Actuated Cycle Length: 120
 Offset: 0 (0%), Referenced to phase 2:EBTL and 6:WBTL, Start of Green
 Natural Cycle: 65
 Control Type: Actuated-Coordinated

Splits and Phases: 3: Clarkway Drive/Humber Station Road & Mayfield Road

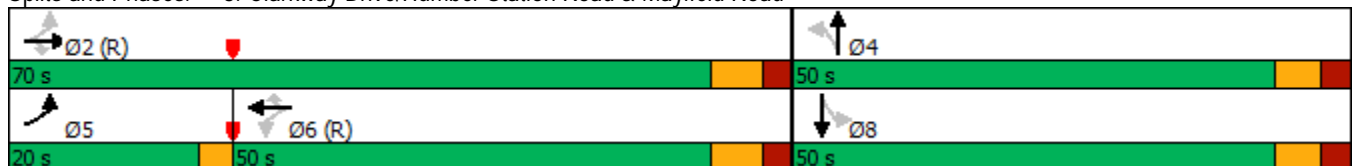

HCM Signalized Intersection Capacity Analysis

Future Background (2033) - Optimized

3: Clarkway Drive/Humber Station Road & Mayfield Road

AM Peak Hour



Movement	EBL	EBT	EBR	WBL	WBT	WBR	NBL	NBT	NBR	SBL	SBT	SBR
Lane Configurations	↘	↑↑↑	↗	↘	↑↑	↗	↘	↗		↘	↗	
Traffic Volume (vph)	8	848	28	102	623	21	11	57	212	23	272	8
Future Volume (vph)	8	848	28	102	623	21	11	57	212	23	272	8
Ideal Flow (vphpl)	1900	1900	1900	1900	1900	1900	1900	1900	1900	1900	1900	1900
Lane Width	3.0	3.5	3.0	3.0	3.5	3.0	3.0	3.5	3.0	3.0	3.5	3.0
Total Lost time (s)	3.0	7.3	7.3	7.3	7.3	7.3	7.0	7.0		7.0	7.0	
Lane Util. Factor	1.00	0.91	1.00	1.00	0.95	1.00	1.00	1.00		1.00	1.00	
Frt	1.00	1.00	0.85	1.00	1.00	0.85	1.00	0.88		1.00	1.00	
Flt Protected	0.95	1.00	1.00	0.95	1.00	1.00	0.95	1.00		0.95	1.00	
Satd. Flow (prot)	1491	4499	1206	1574	3077	1370	1428	1599		1546	1853	
Flt Permitted	0.38	1.00	1.00	0.31	1.00	1.00	0.31	1.00		0.33	1.00	
Satd. Flow (perm)	590	4499	1206	513	3077	1370	465	1599		540	1853	
Peak-hour factor, PHF	0.96	0.96	0.96	0.96	0.96	0.96	0.96	0.96	0.96	0.96	0.96	0.96
Adj. Flow (vph)	8	883	29	106	649	22	11	59	221	24	283	8
RTOR Reduction (vph)	0	0	9	0	0	8	0	93	0	0	1	0
Lane Group Flow (vph)	8	883	20	106	649	14	11	187	0	24	290	0
Heavy Vehicles (%)	13%	14%	25%	7%	16%	10%	18%	2%	4%	9%	1%	0%
Turn Type	pm+pt	NA	Perm	Perm	NA	Perm	Perm	NA		Perm	NA	
Protected Phases	5	2			6			4			8	
Permitted Phases	2		2	6		6	4			8		
Actuated Green, G (s)	81.3	81.3	81.3	77.0	77.0	77.0	24.4	24.4		24.4	24.4	
Effective Green, g (s)	81.3	81.3	81.3	77.0	77.0	77.0	24.4	24.4		24.4	24.4	
Actuated g/C Ratio	0.68	0.68	0.68	0.64	0.64	0.64	0.20	0.20		0.20	0.20	
Clearance Time (s)	3.0	7.3	7.3	7.3	7.3	7.3	7.0	7.0		7.0	7.0	
Vehicle Extension (s)	3.0	3.0	3.0	3.0	3.0	3.0	3.0	3.0		3.0	3.0	
Lane Grp Cap (vph)	409	3048	817	329	1974	879	94	325		109	376	
v/s Ratio Prot	0.00	c0.20			c0.21			0.12			c0.16	
v/s Ratio Perm	0.01		0.02	0.21		0.01	0.02			0.04		
v/c Ratio	0.02	0.29	0.02	0.32	0.33	0.02	0.12	0.57		0.22	0.77	
Uniform Delay, d1	6.4	7.8	6.3	9.7	9.8	7.8	39.0	43.1		39.9	45.2	
Progression Factor	1.00	1.00	1.00	1.00	1.00	1.00	1.00	1.00		0.99	1.02	
Incremental Delay, d2	0.0	0.2	0.1	2.6	0.4	0.0	0.6	2.5		1.0	9.4	
Delay (s)	6.4	8.0	6.4	12.3	10.2	7.8	39.6	45.6		40.5	55.3	
Level of Service	A	A	A	B	B	A	D	D		D	E	
Approach Delay (s)		7.9			10.4			45.3			54.2	
Approach LOS		A			B			D			D	

Intersection Summary

HCM 2000 Control Delay	19.8	HCM 2000 Level of Service	B
HCM 2000 Volume to Capacity ratio	0.43		
Actuated Cycle Length (s)	120.0	Sum of lost time (s)	17.3
Intersection Capacity Utilization	63.5%	ICU Level of Service	B
Analysis Period (min)	15		

c Critical Lane Group

Queues
4: Coleraine Drive & Mayfield Road

Future Background (2033) - Optimized
AM Peak Hour



Lane Group	EBL	EBT	WBL	WBT	NBL	NBT	SBL	SBT
Lane Configurations	↖	↕	↖	↕	↖	↕	↖	↕
Traffic Volume (vph)	329	551	44	552	20	148	67	339
Future Volume (vph)	329	551	44	552	20	148	67	339
Lane Group Flow (vph)	374	683	50	670	23	178	76	626
Turn Type	pm+pt	NA	Perm	NA	Perm	NA	pm+pt	NA
Protected Phases	5	2		6		4	3	8
Permitted Phases	2		6		4		8	
Detector Phase	5	2	6	6	4	4	3	8
Switch Phase								
Minimum Initial (s)	5.0	12.0	12.0	12.0	12.0	12.0	5.0	12.0
Minimum Split (s)	8.0	37.0	37.0	37.0	37.0	37.0	8.0	37.0
Total Split (s)	15.0	80.0	65.0	65.0	32.0	32.0	18.0	50.0
Total Split (%)	11.5%	61.5%	50.0%	50.0%	24.6%	24.6%	13.8%	38.5%
Yellow Time (s)	3.0	4.6	4.6	4.6	4.2	4.2	3.0	4.2
All-Red Time (s)	0.0	2.4	2.4	2.4	2.8	2.8	0.0	2.8
Lost Time Adjust (s)	0.0	0.0	0.0	0.0	0.0	0.0	0.0	0.0
Total Lost Time (s)	3.0	7.0	7.0	7.0	7.0	7.0	3.0	7.0
Lead/Lag	Lead		Lag	Lag	Lag	Lag	Lead	
Lead-Lag Optimize?	Yes		Yes	Yes	Yes	Yes	Yes	
Recall Mode	None	C-Max	C-Max	C-Max	None	None	None	None
v/c Ratio	0.68	0.32	0.14	0.41	0.37	0.42	0.30	0.82
Control Delay	14.9	9.4	21.3	21.9	71.2	55.6	41.0	49.3
Queue Delay	0.0	0.0	0.0	0.0	0.0	0.0	0.0	0.0
Total Delay	14.9	9.4	21.3	21.9	71.2	55.6	41.0	49.3
Queue Length 50th (m)	34.0	35.2	7.2	58.3	5.9	23.7	16.6	71.3
Queue Length 95th (m)	59.4	53.6	16.7	79.2	15.2	34.2	27.6	84.2
Internal Link Dist (m)		290.4		1003.7		791.2		576.8
Turn Bay Length (m)	100.0		85.0		105.0		145.0	
Base Capacity (vph)	546	2112	350	1650	101	680	270	1127
Starvation Cap Reductn	0	0	0	0	0	0	0	0
Spillback Cap Reductn	0	0	0	0	0	0	0	0
Storage Cap Reductn	0	0	0	0	0	0	0	0
Reduced v/c Ratio	0.68	0.32	0.14	0.41	0.23	0.26	0.28	0.56

Intersection Summary

Cycle Length: 130
 Actuated Cycle Length: 130
 Offset: 92 (71%), Referenced to phase 2:EBTL and 6:WBTL, Start of Green
 Natural Cycle: 90
 Control Type: Actuated-Coordinated





















Splits and Phases: 4: Coleraine Drive & Mayfield Road



HCM Signalized Intersection Capacity Analysis

4: Coleraine Drive & Mayfield Road

Future Background (2033) - Optimized
AM Peak Hour

												
Movement	EBL	EBT	EBR	WBL	WBT	WBR	NBL	NBT	NBR	SBL	SBT	SBR
Lane Configurations												
Traffic Volume (vph)	329	551	50	44	552	38	20	148	9	67	339	212
Future Volume (vph)	329	551	50	44	552	38	20	148	9	67	339	212
Ideal Flow (vphpl)	1900	1900	1900	1900	1900	1900	1900	1900	1900	1900	1900	1900
Lane Width	3.0	3.5	3.0	3.0	3.5	3.0	3.0	3.5	3.0	3.0	3.5	3.0
Total Lost time (s)	3.0	7.0		7.0	7.0		7.0	7.0		3.0	7.0	
Lane Util. Factor	1.00	0.95		1.00	0.95		1.00	0.95		1.00	0.95	
Flt	1.00	0.99		1.00	0.99		1.00	0.99		1.00	0.94	
Flt Protected	0.95	1.00		0.95	1.00		0.95	1.00		0.95	1.00	
Satd. Flow (prot)	1574	3095		1685	3267		1532	3518		1452	3180	
Flt Permitted	0.33	1.00		0.39	1.00		0.33	1.00		0.54	1.00	
Satd. Flow (perm)	543	3095		695	3267		527	3518		818	3180	
Peak-hour factor, PHF	0.88	0.88	0.88	0.88	0.88	0.88	0.88	0.88	0.88	0.88	0.88	0.88
Adj. Flow (vph)	374	626	57	50	627	43	23	168	10	76	385	241
RTOR Reduction (vph)	0	4	0	0	4	0	0	4	0	0	89	0
Lane Group Flow (vph)	374	679	0	50	666	0	23	174	0	76	537	0
Heavy Vehicles (%)	7%	15%	2%	0%	7%	26%	10%	0%	11%	16%	0%	15%
Turn Type	pm+pt	NA		Perm	NA		Perm	NA		pm+pt	NA	
Protected Phases	5	2			6			4		3	8	
Permitted Phases	2			6			4			8		
Actuated Green, G (s)	88.0	88.0		64.9	64.9		15.4	15.4		28.0	28.0	
Effective Green, g (s)	88.0	88.0		64.9	64.9		15.4	15.4		28.0	28.0	
Actuated g/C Ratio	0.68	0.68		0.50	0.50		0.12	0.12		0.22	0.22	
Clearance Time (s)	3.0	7.0		7.0	7.0		7.0	7.0		3.0	7.0	
Vehicle Extension (s)	3.0	3.0		3.0	3.0		3.0	3.0		3.0	3.0	
Lane Grp Cap (vph)	526	2095		346	1630		62	416		223	684	
v/s Ratio Prot	c0.11	0.22			0.20			0.05		0.03	c0.17	
v/s Ratio Perm	c0.37			0.07			0.04			0.05		
v/c Ratio	0.71	0.32		0.14	0.41		0.37	0.42		0.34	0.79	
Uniform Delay, d1	10.2	8.7		17.6	20.5		52.8	53.2		42.3	48.2	
Progression Factor	1.00	1.00		1.00	1.00		1.00	1.00		1.00	1.00	
Incremental Delay, d2	4.5	0.4		0.9	0.8		3.7	0.7		0.9	5.9	
Delay (s)	14.7	9.1		18.4	21.2		56.6	53.8		43.2	54.1	
Level of Service	B	A		B	C		E	D		D	D	
Approach Delay (s)		11.1			21.0			54.1			52.9	
Approach LOS		B			C			D			D	
Intersection Summary												
HCM 2000 Control Delay			27.9									C
HCM 2000 Volume to Capacity ratio			0.77									
Actuated Cycle Length (s)			130.0								20.0	
Intersection Capacity Utilization			81.7%									D
Analysis Period (min)			15									

c Critical Lane Group

Queues

5: Coleraine Drive & Private Access/George Bolton Parkway



Lane Group	EBL	EBT	WBL	WBT	NBL	NBT	SBL	SBT	SBR
Lane Configurations	↶	↷	↶	↷	↶	↷	↶	↷	↷
Traffic Volume (vph)	4	12	63	23	30	372	84	476	11
Future Volume (vph)	4	12	63	23	30	372	84	476	11
Lane Group Flow (vph)	5	29	73	191	35	545	98	553	13
Turn Type	Perm	NA	Perm	NA	Perm	NA	Perm	NA	Perm
Protected Phases		8		4		6		2	
Permitted Phases	8		4		6		2		2
Detector Phase	8	8	4	4	6	6	2	2	2
Switch Phase									
Minimum Initial (s)	8.0	8.0	12.0	12.0	12.0	12.0	12.0	12.0	12.0
Minimum Split (s)	32.5	32.5	32.5	32.5	34.2	34.2	33.7	33.7	33.7
Total Split (s)	45.0	45.0	45.0	45.0	55.0	55.0	55.0	55.0	55.0
Total Split (%)	45.0%	45.0%	45.0%	45.0%	55.0%	55.0%	55.0%	55.0%	55.0%
Yellow Time (s)	4.0	4.0	4.0	4.0	4.2	4.2	4.2	4.2	4.2
All-Red Time (s)	3.5	3.5	3.5	3.5	2.5	2.5	2.5	2.5	2.5
Lost Time Adjust (s)	0.0	0.0	0.0	0.0	0.0	0.0	0.0	0.0	0.0
Total Lost Time (s)	7.5	7.5	7.5	7.5	6.7	6.7	6.7	6.7	6.7
Lead/Lag									
Lead-Lag Optimize?									
Recall Mode	None	None	None	None	C-Max	C-Max	C-Max	C-Max	C-Max
v/c Ratio	0.04	0.15	0.52	0.56	0.08	0.25	0.18	0.25	0.01
Control Delay	35.2	24.0	52.1	15.3	5.6	5.2	6.3	5.6	0.0
Queue Delay	0.0	0.0	0.0	0.0	0.0	0.0	0.0	0.0	0.0
Total Delay	35.2	24.0	52.1	15.3	5.6	5.2	6.3	5.6	0.0
Queue Length 50th (m)	0.9	2.6	14.2	5.0	1.7	14.6	5.2	16.4	0.0
Queue Length 95th (m)	3.9	9.7	25.9	21.4	5.7	25.7	13.5	28.2	0.0
Internal Link Dist (m)		152.4		468.8		784.9		1711.9	
Turn Bay Length (m)	70.0		105.0		75.0		100.0		100.0
Base Capacity (vph)	345	486	369	633	458	2145	536	2216	1001
Starvation Cap Reductn	0	0	0	0	0	0	0	0	0
Spillback Cap Reductn	0	0	0	0	0	0	0	0	0
Storage Cap Reductn	0	0	0	0	0	0	0	0	0
Reduced v/c Ratio	0.01	0.06	0.20	0.30	0.08	0.25	0.18	0.25	0.01

Intersection Summary

Cycle Length: 100
 Actuated Cycle Length: 100
 Offset: 0 (0%), Referenced to phase 2:SBTL and 6:NBTL, Start of Green
 Natural Cycle: 70
 Control Type: Actuated-Coordinated

Splits and Phases: 5: Coleraine Drive & Private Access/George Bolton Parkway

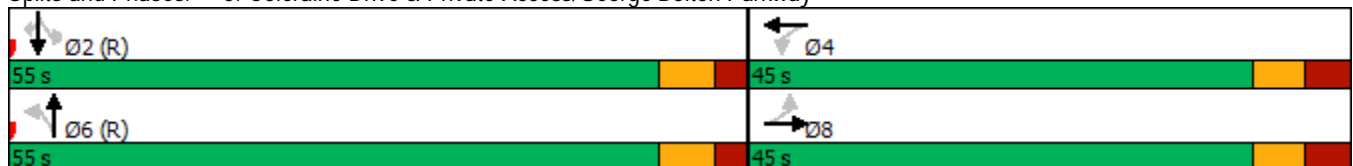

HCM Signalized Intersection Capacity Analysis

Future Background (2033) - Optimized

5: Coleraine Drive & Private Access/George Bolton Parkway

AM Peak Hour



Movement	EBL	EBT	EBR	WBL	WBT	WBR	NBL	NBT	NBR	SBL	SBT	SBR
Lane Configurations	↖	↗		↖	↗		↖	↕		↖	↗	↖
Traffic Volume (vph)	4	12	13	63	23	141	30	372	96	84	476	11
Future Volume (vph)	4	12	13	63	23	141	30	372	96	84	476	11
Ideal Flow (vphpl)	1900	1900	1900	1900	1900	1900	1900	1900	1900	1900	1900	1900
Lane Width	3.0	3.5	3.0	3.0	3.5	3.0	3.0	3.5	3.0	3.0	3.5	3.0
Total Lost time (s)	7.5	7.5		7.5	7.5		6.7	6.7		6.7	6.7	6.7
Lane Util. Factor	1.00	1.00		1.00	1.00		1.00	0.95		1.00	0.95	1.00
Fr _t	1.00	0.92		1.00	0.87		1.00	0.97		1.00	1.00	0.85
Fl _t Protected	0.95	1.00		0.95	1.00		0.95	1.00		0.95	1.00	1.00
Satd. Flow (prot)	1685	1271		1267	1417		1370	2987		1589	3104	1383
Fl _t Permitted	0.52	1.00		0.74	1.00		0.45	1.00		0.45	1.00	1.00
Satd. Flow (perm)	921	1271		984	1417		642	2987		750	3104	1383
Peak-hour factor, PHF	0.86	0.86	0.86	0.86	0.86	0.86	0.86	0.86	0.86	0.86	0.86	0.86
Adj. Flow (vph)	5	14	15	73	27	164	35	433	112	98	553	13
RTOR Reduction (vph)	0	13	0	0	140	0	0	13	0	0	0	4
Lane Group Flow (vph)	5	16	0	73	51	0	35	532	0	98	553	9
Heavy Vehicles (%)	0%	42%	31%	33%	43%	11%	23%	15%	19%	6%	15%	9%
Turn Type	Perm	NA		Perm	NA		Perm	NA		Perm	NA	Perm
Protected Phases		8			4			6			2	
Permitted Phases	8			4			6			2		2
Actuated Green, G (s)	14.4	14.4		14.4	14.4		71.4	71.4		71.4	71.4	71.4
Effective Green, g (s)	14.4	14.4		14.4	14.4		71.4	71.4		71.4	71.4	71.4
Actuated g/C Ratio	0.14	0.14		0.14	0.14		0.71	0.71		0.71	0.71	0.71
Clearance Time (s)	7.5	7.5		7.5	7.5		6.7	6.7		6.7	6.7	6.7
Vehicle Extension (s)	3.0	3.0		3.0	3.0		3.0	3.0		3.0	3.0	3.0
Lane Grp Cap (vph)	132	183		141	204		458	2132		535	2216	987
v/s Ratio Prot		0.01			0.04			0.18			c0.18	
v/s Ratio Perm	0.01			c0.07			0.05			0.13		0.01
v/c Ratio	0.04	0.09		0.52	0.25		0.08	0.25		0.18	0.25	0.01
Uniform Delay, d ₁	36.8	37.1		39.6	38.0		4.3	5.0		4.7	5.0	4.1
Progression Factor	1.00	1.00		1.00	1.00		1.00	1.00		1.00	1.00	1.00
Incremental Delay, d ₂	0.1	0.2		3.2	0.6		0.3	0.3		0.8	0.3	0.0
Delay (s)	37.0	37.3		42.8	38.6		4.7	5.3		5.5	5.2	4.1
Level of Service	D	D		D	D		A	A		A	A	A
Approach Delay (s)		37.3			39.8			5.2			5.3	
Approach LOS		D			D			A			A	

Intersection Summary

HCM 2000 Control Delay	11.9	HCM 2000 Level of Service	B
HCM 2000 Volume to Capacity ratio	0.29		
Actuated Cycle Length (s)	100.0	Sum of lost time (s)	14.2
Intersection Capacity Utilization	50.9%	ICU Level of Service	A
Analysis Period (min)	15		

c Critical Lane Group

Queues

Future Background (2033) - Optimized

6: Highway 50 & George Bolton Parkway/Private Access

AM Peak Hour



Lane Group	EBL	EBT	WBT	NBL	NBT	SBL	SBT	SBR
Lane Configurations								
Traffic Volume (vph)	76	0	0	161	933	3	1144	138
Future Volume (vph)	76	0	0	161	933	3	1144	138
Lane Group Flow (vph)	79	108	1	168	972	3	1192	144
Turn Type	Perm	NA	NA	pm+pt	NA	Perm	NA	Perm
Protected Phases		8	4	1	6		2	
Permitted Phases	8			6		2		2
Detector Phase	8	8	4	1	6	2	2	2
Switch Phase								
Minimum Initial (s)	8.0	8.0	8.0	5.0	12.0	12.0	12.0	12.0
Minimum Split (s)	32.6	32.6	32.6	8.0	27.3	27.3	27.3	27.3
Total Split (s)	35.0	35.0	35.0	10.0	85.0	75.0	75.0	75.0
Total Split (%)	29.2%	29.2%	29.2%	8.3%	70.8%	62.5%	62.5%	62.5%
Yellow Time (s)	4.0	4.0	4.0	3.0	4.0	4.0	4.0	4.0
All-Red Time (s)	2.6	2.6	2.6	0.0	2.3	2.3	2.3	2.3
Lost Time Adjust (s)	0.0	0.0	0.0	0.0	0.0	0.0	0.0	0.0
Total Lost Time (s)	6.6	6.6	6.6	3.0	6.3	6.3	6.3	6.3
Lead/Lag				Lead		Lag	Lag	Lag
Lead-Lag Optimize?				Yes		Yes	Yes	Yes
Recall Mode	None	None	None	None	C-Max	C-Max	C-Max	C-Max
v/c Ratio	0.59	0.40	0.00	0.54	0.37	0.01	0.54	0.14
Control Delay	67.3	5.8	0.0	9.6	4.8	9.0	12.2	2.2
Queue Delay	0.0	0.0	0.0	0.0	0.0	0.0	0.0	0.0
Total Delay	67.3	5.8	0.0	9.6	4.8	9.0	12.2	2.2
Queue Length 50th (m)	18.9	0.0	0.0	7.2	32.0	0.2	71.1	0.5
Queue Length 95th (m)	34.2	4.3	0.0	16.1	51.7	1.7	116.7	9.3
Internal Link Dist (m)		846.5	43.0		1045.6		1307.8	
Turn Bay Length (m)	85.0			40.0		135.0		60.0
Base Capacity (vph)	286	399	502	311	2655	351	2221	1018
Starvation Cap Reductn	0	0	0	0	0	0	0	0
Spillback Cap Reductn	0	0	0	0	0	0	0	0
Storage Cap Reductn	0	0	0	0	0	0	0	0
Reduced v/c Ratio	0.28	0.27	0.00	0.54	0.37	0.01	0.54	0.14

Intersection Summary





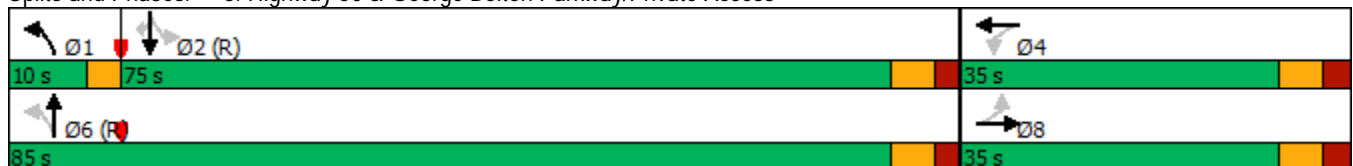















Cycle Length: 120
 Actuated Cycle Length: 120
 Offset: 113 (94%), Referenced to phase 2:SBTL and 6:NBTL, Start of Green
 Natural Cycle: 80
 Control Type: Actuated-Coordinated

Splits and Phases: 6: Highway 50 & George Bolton Parkway/Private Access



HCM Signalized Intersection Capacity Analysis
6: Highway 50 & George Bolton Parkway/Private Access

Future Background (2033) - Optimized
AM Peak Hour

													
Movement	EBL	EBT	EBR	WBL	WBT	WBR	NBL	NBT	NBR	SBL	SBT	SBR	
Lane Configurations													
Traffic Volume (vph)	76	0	104	0	0	1	161	933	0	3	1144	138	
Future Volume (vph)	76	0	104	0	0	1	161	933	0	3	1144	138	
Ideal Flow (vphpl)	1900	1900	1900	1900	1900	1900	1900	1900	1900	1900	1900	1900	
Lane Width	3.0	3.5	3.0	3.0	3.5	3.0	3.0	3.5	3.0	3.0	3.5	3.0	
Total Lost time (s)	6.6	6.6			6.6		3.0	6.3		6.3	6.3	6.3	
Lane Util. Factor	1.00	1.00			1.00		1.00	0.95		1.00	0.95	1.00	
Frt	1.00	0.85			0.86		1.00	1.00		1.00	1.00	0.85	
Flt Protected	0.95	1.00			1.00		0.95	1.00		0.95	1.00	1.00	
Satd. Flow (prot)	1518	1166			1625		1381	3400		1685	3305	1449	
Flt Permitted	0.76	1.00			1.00		0.19	1.00		0.29	1.00	1.00	
Satd. Flow (perm)	1210	1166			1625		271	3400		523	3305	1449	
Peak-hour factor, PHF	0.96	0.96	0.96	0.96	0.96	0.96	0.96	0.96	0.96	0.96	0.96	0.96	
Adj. Flow (vph)	79	0	108	0	0	1	168	972	0	3	1192	144	
RTOR Reduction (vph)	0	96	0	0	1	0	0	0	0	0	0	45	
Lane Group Flow (vph)	79	12	0	0	0	0	168	972	0	3	1192	99	
Heavy Vehicles (%)	11%	0%	37%	0%	0%	0%	22%	5%	0%	0%	8%	4%	
Turn Type	Perm	NA			NA		pm+pt	NA		Perm	NA	Perm	
Protected Phases		8			4		1	6			2		
Permitted Phases	8			4			6			2		2	
Actuated Green, G (s)	13.4	13.4			13.4		93.7	93.7		80.6	80.6	80.6	
Effective Green, g (s)	13.4	13.4			13.4		93.7	93.7		80.6	80.6	80.6	
Actuated g/C Ratio	0.11	0.11			0.11		0.78	0.78		0.67	0.67	0.67	
Clearance Time (s)	6.6	6.6			6.6		3.0	6.3		6.3	6.3	6.3	
Vehicle Extension (s)	3.0	3.0			3.0		3.0	3.0		3.0	3.0	3.0	
Lane Grp Cap (vph)	135	130			181		305	2654		351	2219	973	
v/s Ratio Prot		0.01			0.00		c0.05	0.29			0.36		
v/s Ratio Perm	c0.07						c0.38			0.01		0.07	
v/c Ratio	0.59	0.09			0.00		0.55	0.37		0.01	0.54	0.10	
Uniform Delay, d1	50.7	47.8			47.4		5.9	4.0		6.5	10.1	6.9	
Progression Factor	1.00	1.00			1.00		1.00	1.00		1.00	1.00	1.00	
Incremental Delay, d2	6.3	0.3			0.0		2.1	0.4		0.0	0.9	0.2	
Delay (s)	57.0	48.2			47.4		8.0	4.4		6.5	11.1	7.2	
Level of Service	E	D			D		A	A		A	B	A	
Approach Delay (s)		51.9			47.4			5.0			10.6		
Approach LOS		D			D			A			B		

Intersection Summary

HCM 2000 Control Delay	11.1	HCM 2000 Level of Service	B
HCM 2000 Volume to Capacity ratio	0.57		
Actuated Cycle Length (s)	120.0	Sum of lost time (s)	15.9
Intersection Capacity Utilization	65.5%	ICU Level of Service	C
Analysis Period (min)	15		

c Critical Lane Group

	↑	↓	
Lane Group	NBT	SBT	Ø8
Lane Configurations	↑	↑	
Traffic Volume (vph)	86	303	
Future Volume (vph)	86	303	
Lane Group Flow (vph)	86	303	
Turn Type	NA	NA	
Protected Phases	2	6	8
Permitted Phases			
Detector Phase	2	6	
Switch Phase			
Minimum Initial (s)	12.0	12.0	12.0
Minimum Split (s)	24.7	24.7	25.5
Total Split (s)	75.0	75.0	45.0
Total Split (%)	62.5%	62.5%	38%
Yellow Time (s)	4.2	4.2	4.0
All-Red Time (s)	2.5	2.5	3.5
Lost Time Adjust (s)	0.0	0.0	
Total Lost Time (s)	6.7	6.7	
Lead/Lag			
Lead-Lag Optimize?			
Recall Mode	C-Max	C-Max	None
v/c Ratio	0.05	0.16	
Control Delay	0.0	0.2	
Queue Delay	0.0	0.0	
Total Delay	0.0	0.2	
Queue Length 50th (m)	0.0	0.0	
Queue Length 95th (m)	0.0	0.0	
Internal Link Dist (m)	1542.4	460.2	
Turn Bay Length (m)			
Base Capacity (vph)	1789	1860	
Starvation Cap Reductn	0	0	
Spillback Cap Reductn	0	0	
Storage Cap Reductn	0	0	
Reduced v/c Ratio	0.05	0.16	

Intersection Summary

Cycle Length: 120
 Actuated Cycle Length: 120
 Offset: 0 (0%), Referenced to phase 2:NBT and 6:SBTL, Start of Green
 Natural Cycle: 55
 Control Type: Actuated-Coordinated

Splits and Phases: 9: Humber Station Road & Subject Lands Site Access #1

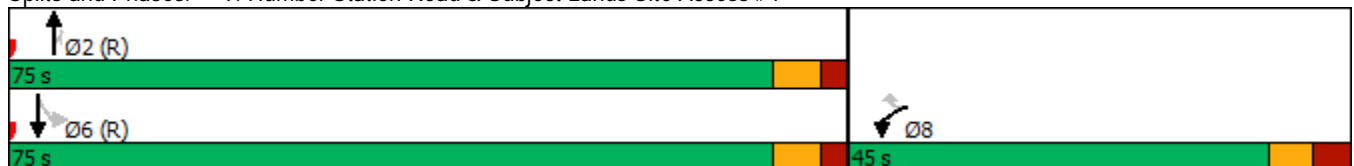

HCM Signalized Intersection Capacity Analysis
 9: Humber Station Road & Subject Lands Site Access #1

Future Background (2033) - Optimized
 AM Peak Hour



Movement	WBL	WBR	NBT	NBR	SBL	SBT
Lane Configurations	↶	↷	↕	↷	↶	↕
Traffic Volume (vph)	0	0	86	0	0	303
Future Volume (vph)	0	0	86	0	0	303
Ideal Flow (vphpl)	1900	1900	1900	1900	1900	1900
Lane Width	3.0	3.0	3.5	3.0	3.0	3.5
Total Lost time (s)			6.7			6.7
Lane Util. Factor			1.00			1.00
Frt			1.00			1.00
Flt Protected			1.00			1.00
Satd. Flow (prot)			1789			1860
Flt Permitted			1.00			1.00
Satd. Flow (perm)			1789			1860
Peak-hour factor, PHF	1.00	1.00	1.00	1.00	1.00	1.00
Adj. Flow (vph)	0	0	86	0	0	303
RTOR Reduction (vph)	0	0	0	0	0	0
Lane Group Flow (vph)	0	0	86	0	0	303
Heavy Vehicles (%)	0%	0%	5%	0%	0%	1%
Turn Type	Prot	Perm	NA	Perm	Perm	NA
Protected Phases	8		2			6
Permitted Phases		8		2	6	
Actuated Green, G (s)			120.0			120.0
Effective Green, g (s)			120.0			120.0
Actuated g/C Ratio			1.00			1.00
Clearance Time (s)			6.7			6.7
Vehicle Extension (s)			3.0			3.0
Lane Grp Cap (vph)			1789			1860
v/s Ratio Prot			0.05			c0.16
v/s Ratio Perm						
v/c Ratio			0.05			0.16
Uniform Delay, d1			0.0			0.0
Progression Factor			1.00			1.00
Incremental Delay, d2			0.0			0.2
Delay (s)			0.0			0.2
Level of Service			A			A
Approach Delay (s)	0.0		0.0			0.2
Approach LOS	A		A			A

Intersection Summary

HCM 2000 Control Delay	0.2	HCM 2000 Level of Service	A
HCM 2000 Volume to Capacity ratio	0.18		
Actuated Cycle Length (s)	120.0	Sum of lost time (s)	14.2
Intersection Capacity Utilization	21.5%	ICU Level of Service	A
Analysis Period (min)	15		

c Critical Lane Group

HCM Unsignalized Intersection Capacity Analysis
 24: Mayfield Road & Triangle Lands

Future Background (2033) - Optimized
 AM Peak Hour



Movement	EBL	EBT	WBT	WBR	SBL	SBR	
Lane Configurations							
Traffic Volume (veh/h)	160	923	674	108	33	72	
Future Volume (Veh/h)	160	923	674	108	33	72	
Sign Control		Free	Free		Stop		
Grade		0%	0%		0%		
Peak Hour Factor	1.00	1.00	1.00	1.00	1.00	1.00	
Hourly flow rate (vph)	160	923	674	108	33	72	
Pedestrians							
Lane Width (m)							
Walking Speed (m/s)							
Percent Blockage							
Right turn flare (veh)							
Median type		None	None				
Median storage veh							
Upstream signal (m)			314				
pX, platoon unblocked	0.90				0.90	0.90	
vC, conflicting volume	782				1510	391	
vC1, stage 1 conf vol							
vC2, stage 2 conf vol							
vCu, unblocked vol	543				1349	110	
tC, single (s)	4.2				7.0	7.2	
tC, 2 stage (s)							
tF (s)	2.3				3.6	3.4	
p0 queue free %	82				66	91	
cM capacity (veh/h)	892				96	802	
Direction, Lane #	EB 1	EB 2	EB 3	WB 1	WB 2	SB 1	SB 2
Volume Total	160	462	462	449	333	33	72
Volume Left	160	0	0	0	0	33	0
Volume Right	0	0	0	0	108	0	72
cSH	892	1700	1700	1700	1700	96	802
Volume to Capacity	0.18	0.27	0.27	0.26	0.20	0.34	0.09
Queue Length 95th (m)	5.2	0.0	0.0	0.0	0.0	10.7	2.4
Control Delay (s)	9.9	0.0	0.0	0.0	0.0	60.8	9.9
Lane LOS	A					F	A
Approach Delay (s)	1.5			0.0		25.9	
Approach LOS						D	
Intersection Summary							
Average Delay			2.2				
Intersection Capacity Utilization			44.3%		ICU Level of Service		A
Analysis Period (min)			15				



Movement	WBL	WBR	NBT	NBR	SBL	SBT
Lane Configurations						
Traffic Volume (veh/h)	0	0	86	0	0	303
Future Volume (Veh/h)	0	0	86	0	0	303
Sign Control	Stop		Free		Free	
Grade	0%		0%		0%	
Peak Hour Factor	1.00	1.00	1.00	1.00	1.00	1.00
Hourly flow rate (vph)	0	0	86	0	0	303
Pedestrians						
Lane Width (m)						
Walking Speed (m/s)						
Percent Blockage						
Right turn flare (veh)						
Median type	None			None		
Median storage (veh)						
Upstream signal (m)						
pX, platoon unblocked						
vC, conflicting volume	389	86			86	
vC1, stage 1 conf vol						
vC2, stage 2 conf vol						
vCu, unblocked vol	389	86			86	
tC, single (s)	6.4	6.2			4.1	
tC, 2 stage (s)						
tF (s)	3.5	3.3			2.2	
p0 queue free %	100	100			100	
cM capacity (veh/h)	619	978			1523	
Direction, Lane #	WB 1	WB 2	NB 1	NB 2	SB 1	SB 2
Volume Total	0	0	86	0	0	303
Volume Left	0	0	0	0	0	0
Volume Right	0	0	0	0	0	0
cSH	1700	1700	1700	1700	1700	1700
Volume to Capacity	0.00	0.00	0.05	0.00	0.00	0.18
Queue Length 95th (m)	0.0	0.0	0.0	0.0	0.0	0.0
Control Delay (s)	0.0	0.0	0.0	0.0	0.0	0.0
Lane LOS	A	A				
Approach Delay (s)	0.0		0.0		0.0	
Approach LOS	A					
Intersection Summary						
Average Delay			0.0			
Intersection Capacity Utilization			19.3%	ICU Level of Service	A	
Analysis Period (min)			15			

HCM Unsignalized Intersection Capacity Analysis
 27: Subject Lands Site Access #4 & Healey Road













Future Background (2033) - Optimized
 AM Peak Hour



Movement	EBT	EBR	WBL	WBT	NBL	NBR
Lane Configurations	↻			↻	↻	↻
Traffic Volume (veh/h)	825	0	0	397	0	0
Future Volume (Veh/h)	825	0	0	397	0	0
Sign Control	Free			Free	Stop	
Grade	0%			0%	0%	
Peak Hour Factor	1.00	1.00	1.00	1.00	1.00	1.00
Hourly flow rate (vph)	825	0	0	397	0	0
Pedestrians						
Lane Width (m)						
Walking Speed (m/s)						
Percent Blockage						
Right turn flare (veh)						
Median type	None			None		
Median storage veh)						
Upstream signal (m)						
pX, platoon unblocked						
vC, conflicting volume			825		1222	825
vC1, stage 1 conf vol						
vC2, stage 2 conf vol						
vCu, unblocked vol			825		1222	825
tC, single (s)			4.1		6.4	6.2
tC, 2 stage (s)						
tF (s)			2.2		3.5	3.3
p0 queue free %			100		100	100
cM capacity (veh/h)			814		200	376
Direction, Lane #	EB 1	WB 1	NB 1	NB 2		
Volume Total	825	397	0	0		
Volume Left	0	0	0	0		
Volume Right	0	0	0	0		
cSH	1700	814	1700	1700		
Volume to Capacity	0.49	0.00	0.00	0.00		
Queue Length 95th (m)	0.0	0.0	0.0	0.0		
Control Delay (s)	0.0	0.0	0.0	0.0		
Lane LOS			A	A		
Approach Delay (s)	0.0	0.0	0.0			
Approach LOS			A			
Intersection Summary						
Average Delay			0.0			
Intersection Capacity Utilization			46.8%	ICU Level of Service		A
Analysis Period (min)			15			

HCM Unsignalized Intersection Capacity Analysis
 28: Humber Station Road & Subject Lands Site Access #2

Future Background (2033) - Optimized
 AM Peak Hour

						
Movement	WBL	WBR	NBT	NBR	SBL	SBT
Lane Configurations						
Traffic Volume (veh/h)	0	0	86	0	0	303
Future Volume (Veh/h)	0	0	86	0	0	303
Sign Control	Stop		Free		Free	
Grade	0%		0%		0%	
Peak Hour Factor	1.00	1.00	1.00	1.00	1.00	1.00
Hourly flow rate (vph)	0	0	86	0	0	303
Pedestrians						
Lane Width (m)						
Walking Speed (m/s)						
Percent Blockage						
Right turn flare (veh)						
Median type			None		None	
Median storage veh						
Upstream signal (m)						
pX, platoon unblocked						
vC, conflicting volume	389	86			86	
vC1, stage 1 conf vol						
vC2, stage 2 conf vol						
vCu, unblocked vol	389	86			86	
tC, single (s)	6.4	6.2			4.1	
tC, 2 stage (s)						
tF (s)	3.5	3.3			2.2	
p0 queue free %	100	100			100	
cM capacity (veh/h)	619	978			1523	
Direction, Lane #	WB 1	WB 2	NB 1	NB 2	SB 1	SB 2
Volume Total	0	0	86	0	0	303
Volume Left	0	0	0	0	0	0
Volume Right	0	0	0	0	0	0
cSH	1700	1700	1700	1700	1700	1700
Volume to Capacity	0.00	0.00	0.05	0.00	0.00	0.18
Queue Length 95th (m)	0.0	0.0	0.0	0.0	0.0	0.0
Control Delay (s)	0.0	0.0	0.0	0.0	0.0	0.0
Lane LOS	A	A				
Approach Delay (s)	0.0		0.0		0.0	
Approach LOS	A					
Intersection Summary						
Average Delay			0.0			
Intersection Capacity Utilization			19.3%		ICU Level of Service	A
Analysis Period (min)			15			

HCM Unsignalized Intersection Capacity Analysis
 29: Mayfield Road & Subject Lands Site Access #5

Future Background (2033) - Optimized
 AM Peak Hour

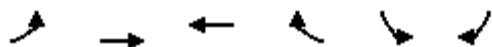

Movement	EBL	EBT	WBT	WBR	SBL	SBR	
Lane Configurations	↖	↗↗	↖↗		↖	↗	
Traffic Volume (veh/h)	0	1083	746	0	0	0	
Future Volume (Veh/h)	0	1083	746	0	0	0	
Sign Control		Free	Free		Stop		
Grade		0%	0%		0%		
Peak Hour Factor	1.00	1.00	1.00	1.00	1.00	1.00	
Hourly flow rate (vph)	0	1083	746	0	0	0	
Pedestrians							
Lane Width (m)							
Walking Speed (m/s)							
Percent Blockage							
Right turn flare (veh)							
Median type		None	None				
Median storage (veh)							
Upstream signal (m)		266					
pX, platoon unblocked					0.91		
vC, conflicting volume	746				1288	373	
vC1, stage 1 conf vol							
vC2, stage 2 conf vol							
vCu, unblocked vol	746				1117	373	
tC, single (s)	4.1				6.8	6.9	
tC, 2 stage (s)							
tF (s)	2.2				3.5	3.3	
p0 queue free %	100				100	100	
cM capacity (veh/h)	871				186	630	
Direction, Lane #	EB 1	EB 2	EB 3	WB 1	WB 2	SB 1	SB 2
Volume Total	0	542	542	497	249	0	0
Volume Left	0	0	0	0	0	0	0
Volume Right	0	0	0	0	0	0	0
cSH	1700	1700	1700	1700	1700	1700	1700
Volume to Capacity	0.00	0.32	0.32	0.29	0.15	0.00	0.00
Queue Length 95th (m)	0.0	0.0	0.0	0.0	0.0	0.0	0.0
Control Delay (s)	0.0	0.0	0.0	0.0	0.0	0.0	0.0
Lane LOS						A	A
Approach Delay (s)	0.0			0.0		0.0	
Approach LOS						A	
Intersection Summary							
Average Delay			0.0				
Intersection Capacity Utilization			33.3%		ICU Level of Service		A
Analysis Period (min)			15				

Queues
1: Coleraine Drive & Healey Road

Future Background (2033) - Optimized
PM Peak Hour



Lane Group	EBL	EBT	WBL	WBT	NBL	NBT	SBL	SBT
Lane Configurations	↶	↷	↶	↷	↶	↷	↶	↷
Traffic Volume (vph)	135	198	56	379	332	418	47	188
Future Volume (vph)	135	198	56	379	332	418	47	188
Lane Group Flow (vph)	148	381	62	509	365	516	52	283
Turn Type	pm+pt	NA	Perm	NA	pm+pt	NA	Perm	NA
Protected Phases	3	8		4	1	6		2
Permitted Phases	8		4		6		2	
Detector Phase	3	8	4	4	1	6	2	2
Switch Phase								
Minimum Initial (s)	5.0	8.0	8.0	8.0	5.0	8.0	8.0	8.0
Minimum Split (s)	9.5	32.8	32.8	32.8	9.5	36.7	36.7	36.7
Total Split (s)	20.0	64.0	44.0	44.0	19.0	56.0	37.0	37.0
Total Split (%)	16.7%	53.3%	36.7%	36.7%	15.8%	46.7%	30.8%	30.8%
Yellow Time (s)	3.0	4.0	4.0	4.0	3.0	4.6	4.6	4.6
All-Red Time (s)	0.0	2.8	2.8	2.8	0.0	2.1	2.1	2.1
Lost Time Adjust (s)	0.0	0.0	0.0	0.0	0.0	0.0	0.0	0.0
Total Lost Time (s)	3.0	6.8	6.8	6.8	3.0	6.7	6.7	6.7
Lead/Lag	Lead		Lag	Lag	Lead		Lag	Lag
Lead-Lag Optimize?	Yes		Yes	Yes	Yes		Yes	Yes
Recall Mode	None	None	None	None	None	C-Max	C-Max	C-Max
v/c Ratio	0.58	0.49	0.23	0.90	0.67	0.37	0.27	0.33
Control Delay	20.9	17.1	31.7	57.8	29.9	23.2	40.6	31.2
Queue Delay	0.0	0.0	0.0	0.0	0.0	0.0	0.0	0.0
Total Delay	20.9	17.1	31.7	57.8	29.9	23.2	40.6	31.2
Queue Length 50th (m)	22.8	63.5	10.9	113.6	61.0	44.2	10.5	25.8
Queue Length 95th (m)	34.4	94.0	23.1	#177.9	92.3	61.0	23.0	39.3
Internal Link Dist (m)		823.7		424.0		1711.9		1121.0
Turn Bay Length (m)	55.0		50.0		80.0		155.0	
Base Capacity (vph)	319	849	284	586	544	1377	196	851
Starvation Cap Reductn	0	0	0	0	0	0	0	0
Spillback Cap Reductn	0	0	0	0	0	0	0	0
Storage Cap Reductn	0	0	0	0	0	0	0	0
Reduced v/c Ratio	0.46	0.45	0.22	0.87	0.67	0.37	0.27	0.33

Intersection Summary





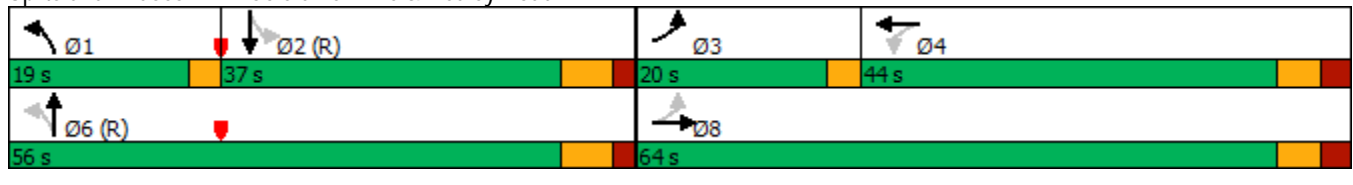

















Cycle Length: 120
 Actuated Cycle Length: 120
 Offset: 0 (0%), Referenced to phase 2:SBTL and 6:NBTL, Start of Green
 Natural Cycle: 90
 Control Type: Actuated-Coordinated
 # 95th percentile volume exceeds capacity, queue may be longer.
 Queue shown is maximum after two cycles.

Splits and Phases: 1: Coleraine Drive & Healey Road



HCM Signalized Intersection Capacity Analysis
1: Coleraine Drive & Healey Road

Future Background (2033) - Optimized
PM Peak Hour

												
Movement	EBL	EBT	EBR	WBL	WBT	WBR	NBL	NBT	NBR	SBL	SBT	SBR
Lane Configurations												
Traffic Volume (vph)	135	198	148	56	379	85	332	418	52	47	188	69
Future Volume (vph)	135	198	148	56	379	85	332	418	52	47	188	69
Ideal Flow (vphpl)	1900	1900	1900	1900	1900	1900	1900	1900	1900	1900	1900	1900
Lane Width	3.0	3.5	3.0	3.0	3.5	3.0	3.0	3.5	3.0	3.0	3.5	3.0
Total Lost time (s)	3.0	6.8		6.8	6.8		3.0	6.7		6.7	6.7	
Lane Util. Factor	1.00	1.00		1.00	1.00		1.00	0.95		1.00	0.95	
Flt	1.00	0.94		1.00	0.97		1.00	0.98		1.00	0.96	
Flt Protected	0.95	1.00		0.95	1.00		0.95	1.00		0.95	1.00	
Satd. Flow (prot)	1668	1734		1546	1775		1668	3047		1416	2872	
Flt Permitted	0.14	1.00		0.54	1.00		0.52	1.00		0.46	1.00	
Satd. Flow (perm)	254	1734		872	1775		905	3047		688	2872	
Peak-hour factor, PHF	0.91	0.91	0.91	0.91	0.91	0.91	0.91	0.91	0.91	0.91	0.91	0.91
Adj. Flow (vph)	148	218	163	62	416	93	365	459	57	52	207	76
RTOR Reduction (vph)	0	24	0	0	7	0	0	7	0	0	30	0
Lane Group Flow (vph)	148	357	0	62	502	0	365	509	0	52	253	0
Heavy Vehicles (%)	1%	1%	2%	9%	0%	16%	1%	15%	17%	19%	26%	1%
Turn Type	pm+pt	NA		Perm	NA		pm+pt	NA		Perm	NA	
Protected Phases	3	8			4		1	6			2	
Permitted Phases	8			4			6			2		
Actuated Green, G (s)	52.5	52.5		38.0	38.0		54.0	54.0		34.3	34.3	
Effective Green, g (s)	52.5	52.5		38.0	38.0		54.0	54.0		34.3	34.3	
Actuated g/C Ratio	0.44	0.44		0.32	0.32		0.45	0.45		0.29	0.29	
Clearance Time (s)	3.0	6.8		6.8	6.8		3.0	6.7		6.7	6.7	
Vehicle Extension (s)	3.0	3.0		3.0	3.0		3.0	3.0		3.0	3.0	
Lane Grp Cap (vph)	246	758		276	562		513	1371		196	820	
v/s Ratio Prot	c0.06	0.21			c0.28		c0.10	0.17			0.09	
v/s Ratio Perm	0.20			0.07			c0.22			0.08		
v/c Ratio	0.60	0.47		0.22	0.89		0.71	0.37		0.27	0.31	
Uniform Delay, d1	25.0	23.9		30.2	39.1		23.7	21.8		33.1	33.6	
Progression Factor	0.68	0.73		1.00	1.00		1.00	1.00		1.00	1.00	
Incremental Delay, d2	3.9	0.4		0.4	16.5		4.6	0.8		3.3	1.0	
Delay (s)	20.9	17.9		30.6	55.6		28.4	22.6		36.4	34.5	
Level of Service	C	B		C	E		C	C		D	C	
Approach Delay (s)		18.7			52.8			25.0			34.8	
Approach LOS		B			D			C			C	
Intersection Summary												
HCM 2000 Control Delay			31.8				HCM 2000 Level of Service			C		
HCM 2000 Volume to Capacity ratio			0.79									
Actuated Cycle Length (s)			120.0				Sum of lost time (s)			19.5		
Intersection Capacity Utilization			76.3%				ICU Level of Service			D		
Analysis Period (min)			15									

c Critical Lane Group

Queues
2: Humber Station Road & Healey Road

Future Background (2033) - Optimized
PM Peak Hour

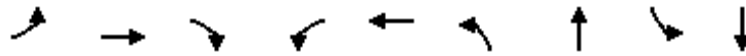

Lane Group	EBL	EBT	EBR	WBL	WBT	NBL	NBT	SBL	SBT
Lane Configurations	↶	↶	↶	↶	↶	↶	↶	↶	↶
Traffic Volume (vph)	21	352	14	34	756	54	228	25	49
Future Volume (vph)	21	352	14	34	756	54	228	25	49
Lane Group Flow (vph)	22	363	14	35	802	56	316	26	57
Turn Type	Perm	NA	Perm	pm+pt	NA	Perm	NA	Perm	NA
Protected Phases		4		3	8		2		6
Permitted Phases	4		4	8		2		6	
Detector Phase	4	4	4	3	8	2	2	6	6
Switch Phase									
Minimum Initial (s)	8.0	8.0	8.0	5.0	8.0	8.0	8.0	8.0	8.0
Minimum Split (s)	24.8	24.8	24.8	8.0	24.8	24.7	24.7	24.7	24.7
Total Split (s)	62.0	62.0	62.0	10.0	72.0	48.0	48.0	48.0	48.0
Total Split (%)	51.7%	51.7%	51.7%	8.3%	60.0%	40.0%	40.0%	40.0%	40.0%
Yellow Time (s)	4.0	4.0	4.0	3.0	4.0	4.6	4.6	4.6	4.6
All-Red Time (s)	2.8	2.8	2.8	0.0	2.8	2.1	2.1	2.1	2.1
Lost Time Adjust (s)	0.0	0.0	0.0	0.0	0.0	0.0	0.0	0.0	0.0
Total Lost Time (s)	6.8	6.8	6.8	3.0	6.8	6.7	6.7	6.7	6.7
Lead/Lag	Lag	Lag	Lag	Lead					
Lead-Lag Optimize?	Yes	Yes	Yes	Yes					
Recall Mode	None	None	None	None	None	C-Max	C-Max	C-Max	C-Max
v/c Ratio	0.21	0.44	0.02	0.08	0.87	0.12	0.45	0.08	0.08
Control Delay	26.0	24.8	0.1	8.1	30.6	36.1	41.3	26.9	23.8
Queue Delay	0.0	0.0	0.0	0.0	0.0	0.0	0.0	0.0	0.0
Total Delay	26.0	24.8	0.1	8.1	30.6	36.1	41.3	26.9	23.8
Queue Length 50th (m)	3.4	62.5	0.0	4.0	188.1	13.6	76.3	4.1	8.2
Queue Length 95th (m)	10.0	85.3	0.0	m4.2	m212.7	27.0	107.0	11.4	18.6
Internal Link Dist (m)		465.5			505.1		463.9		452.2
Turn Bay Length (m)	30.0		30.0	60.0		30.0		30.0	
Base Capacity (vph)	110	853	685	433	1006	459	708	317	715
Starvation Cap Reductn	0	0	0	0	0	0	0	0	0
Spillback Cap Reductn	0	0	0	0	0	0	0	0	0
Storage Cap Reductn	0	0	0	0	0	0	0	0	0
Reduced v/c Ratio	0.20	0.43	0.02	0.08	0.80	0.12	0.45	0.08	0.08

Intersection Summary

Cycle Length: 120
 Actuated Cycle Length: 120
 Offset: 0 (0%), Referenced to phase 2:NBTL and 6:SBTL, Start of Green
 Natural Cycle: 60
 Control Type: Actuated-Coordinated
 m Volume for 95th percentile queue is metered by upstream signal.



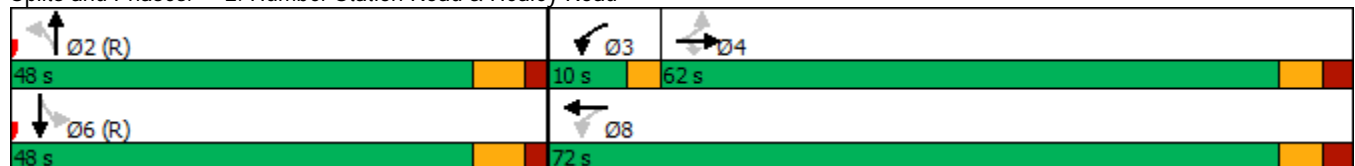

















Splits and Phases: 2: Humber Station Road & Healey Road



HCM Signalized Intersection Capacity Analysis

2: Humber Station Road & Healey Road

Future Background (2033) - Optimized
PM Peak Hour

												
Movement	EBL	EBT	EBR	WBL	WBT	WBR	NBL	NBT	NBR	SBL	SBT	SBR
Lane Configurations												
Traffic Volume (vph)	21	352	14	34	756	22	54	228	79	25	49	6
Future Volume (vph)	21	352	14	34	756	22	54	228	79	25	49	6
Ideal Flow (vphpl)	1900	1900	1900	1900	1900	1900	1900	1900	1900	1900	1900	1900
Lane Width	3.0	3.5	3.0	3.0	3.5	3.0	3.0	3.5	3.0	3.0	3.5	3.0
Total Lost time (s)	6.8	6.8	6.8	3.0	6.8		6.7	6.7		6.7	6.7	
Lane Util. Factor	1.00	1.00	1.00	1.00	1.00		1.00	1.00		1.00	1.00	
Flt	1.00	1.00	0.85	1.00	1.00		1.00	0.96		1.00	0.98	
Flt Protected	0.95	1.00	1.00	0.95	1.00		0.95	1.00		0.95	1.00	
Satd. Flow (prot)	1685	1842	1409	1636	1850		1546	1780		1685	1817	
Flt Permitted	0.13	1.00	1.00	0.42	1.00		0.72	1.00		0.46	1.00	
Satd. Flow (perm)	239	1842	1409	722	1850		1171	1780		808	1817	
Peak-hour factor, PHF	0.97	0.97	0.97	0.97	0.97	0.97	0.97	0.97	0.97	0.97	0.97	0.97
Adj. Flow (vph)	22	363	14	35	779	23	56	235	81	26	51	6
RTOR Reduction (vph)	0	0	8	0	1	0	0	10	0	0	3	0
Lane Group Flow (vph)	22	363	6	35	801	0	56	306	0	26	54	0
Heavy Vehicles (%)	0%	2%	7%	3%	1%	5%	9%	1%	3%	0%	2%	0%
Turn Type	Perm	NA	Perm	pm+pt	NA		Perm	NA		Perm	NA	
Protected Phases		4		3	8			2			6	
Permitted Phases	4		4	8			2			6		
Actuated Green, G (s)	53.5	53.5	53.5	60.7	60.7		45.8	45.8		45.8	45.8	
Effective Green, g (s)	53.5	53.5	53.5	60.7	60.7		45.8	45.8		45.8	45.8	
Actuated g/C Ratio	0.45	0.45	0.45	0.51	0.51		0.38	0.38		0.38	0.38	
Clearance Time (s)	6.8	6.8	6.8	3.0	6.8		6.7	6.7		6.7	6.7	
Vehicle Extension (s)	3.0	3.0	3.0	3.0	3.0		3.0	3.0		3.0	3.0	
Lane Grp Cap (vph)	106	821	628	397	935		446	679		308	693	
v/s Ratio Prot		0.20		0.00	c0.43			c0.17			0.03	
v/s Ratio Perm	0.09		0.00	0.04			0.05			0.03		
v/c Ratio	0.21	0.44	0.01	0.09	0.86		0.13	0.45		0.08	0.08	
Uniform Delay, d1	20.3	23.0	18.5	15.7	25.9		24.1	27.7		23.7	23.6	
Progression Factor	1.00	1.00	1.00	0.66	0.84		1.35	1.43		1.00	1.00	
Incremental Delay, d2	1.0	0.4	0.0	0.1	5.5		0.6	2.1		0.5	0.2	
Delay (s)	21.3	23.3	18.5	10.4	27.3		33.0	41.9		24.2	23.9	
Level of Service	C	C	B	B	C		C	D		C	C	
Approach Delay (s)		23.0			26.6			40.6			24.0	
Approach LOS		C			C			D			C	
Intersection Summary												
HCM 2000 Control Delay			28.7			HCM 2000 Level of Service				C		
HCM 2000 Volume to Capacity ratio			0.70									
Actuated Cycle Length (s)			120.0			Sum of lost time (s)				16.5		
Intersection Capacity Utilization			73.1%			ICU Level of Service				D		
Analysis Period (min)			15									

c Critical Lane Group

Queues

3: Clarkway Drive/Humber Station Road & Mayfield Road

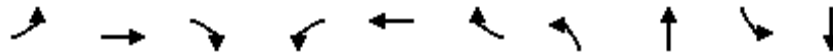

Lane Group	EBL	EBT	EBR	WBL	WBT	WBR	NBL	NBT	SBL	SBT
Lane Configurations	↘	↑↑↑	↗	↘	↑↑	↗	↘	↗	↘	↗
Traffic Volume (vph)	10	783	19	135	905	42	59	299	11	68
Future Volume (vph)	10	783	19	135	905	42	59	299	11	68
Lane Group Flow (vph)	10	807	20	139	933	43	61	487	11	82
Turn Type	pm+pt	NA	Perm	Perm	NA	Perm	Perm	NA	Perm	NA
Protected Phases	5	2			6			4		8
Permitted Phases	2		2	6		6	4		8	
Detector Phase	5	2	2	6	6	6	4	4	8	8
Switch Phase										
Minimum Initial (s)	5.0	12.0	12.0	12.0	12.0	12.0	8.0	8.0	8.0	8.0
Minimum Split (s)	9.5	27.3	27.3	27.3	27.3	27.3	26.0	26.0	26.0	26.0
Total Split (s)	15.0	62.0	62.0	47.0	47.0	47.0	58.0	58.0	58.0	58.0
Total Split (%)	12.5%	51.7%	51.7%	39.2%	39.2%	39.2%	48.3%	48.3%	48.3%	48.3%
Yellow Time (s)	3.0	4.6	4.6	4.6	4.6	4.6	4.2	4.2	4.2	4.2
All-Red Time (s)	0.0	2.7	2.7	2.7	2.7	2.7	2.8	2.8	2.8	2.8
Lost Time Adjust (s)	0.0	0.0	0.0	0.0	0.0	0.0	0.0	0.0	0.0	0.0
Total Lost Time (s)	3.0	7.3	7.3	7.3	7.3	7.3	7.0	7.0	7.0	7.0
Lead/Lag	Lead			Lag	Lag	Lag				
Lead-Lag Optimize?	Yes			Yes	Yes	Yes				
Recall Mode	None	C-Max	C-Max	C-Max	C-Max	C-Max	None	None	None	None
v/c Ratio	0.04	0.31	0.03	0.47	0.53	0.06	0.17	0.84	0.12	0.15
Control Delay	13.3	15.5	2.3	27.8	21.1	2.7	27.8	48.8	27.4	22.7
Queue Delay	0.0	0.0	0.0	0.0	0.0	0.0	0.0	0.0	0.0	0.0
Total Delay	13.3	15.5	2.3	27.8	21.1	2.7	27.8	48.8	27.4	22.7
Queue Length 50th (m)	1.0	37.3	0.0	19.5	71.9	0.0	10.8	105.7	1.9	13.1
Queue Length 95th (m)	4.1	56.2	2.3	#59.1	128.3	4.3	19.1	130.9	6.6	24.0
Internal Link Dist (m)		1635.6			201.2			1951.8		1542.4
Turn Bay Length (m)	150.0		105.0	150.0		115.0	75.0		105.0	
Base Capacity (vph)	306	2614	777	296	1766	761	473	756	132	779
Starvation Cap Reductn	0	0	0	0	0	0	0	0	0	0
Spillback Cap Reductn	0	0	0	0	0	0	0	0	0	0
Storage Cap Reductn	0	0	0	0	0	0	0	0	0	0
Reduced v/c Ratio	0.03	0.31	0.03	0.47	0.53	0.06	0.13	0.64	0.08	0.11

Intersection Summary

Cycle Length: 120
 Actuated Cycle Length: 120
 Offset: 0 (0%), Referenced to phase 2:EBTL and 6:WBTL, Start of Green
 Natural Cycle: 75
 Control Type: Actuated-Coordinated
 # 95th percentile volume exceeds capacity, queue may be longer.
 Queue shown is maximum after two cycles.

Splits and Phases: 3: Clarkway Drive/Humber Station Road & Mayfield Road

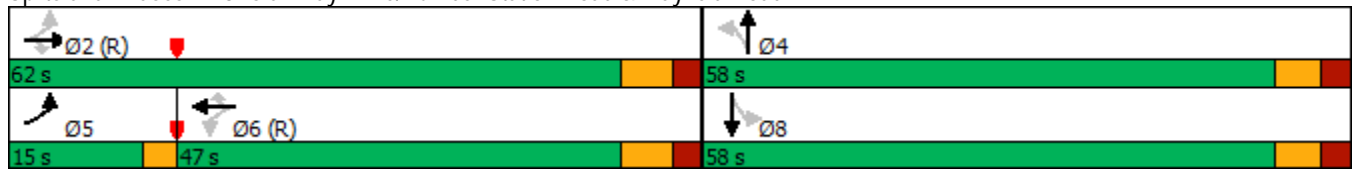

HCM Signalized Intersection Capacity Analysis

Future Background (2033) - Optimized

3: Clarkway Drive/Humber Station Road & Mayfield Road

PM Peak Hour



Movement	EBL	EBT	EBR	WBL	WBT	WBR	NBL	NBT	NBR	SBL	SBT	SBR
Lane Configurations	↘	↑↑↑	↗	↘	↑↑	↗	↘	↗		↘	↗	
Traffic Volume (vph)	10	783	19	135	905	42	59	299	174	11	68	12
Future Volume (vph)	10	783	19	135	905	42	59	299	174	11	68	12
Ideal Flow (vphpl)	1900	1900	1900	1900	1900	1900	1900	1900	1900	1900	1900	1900
Lane Width	3.0	3.5	3.0	3.0	3.5	3.0	3.0	3.5	3.0	3.0	3.5	3.0
Total Lost time (s)	3.0	7.3	7.3	7.3	7.3	7.3	7.0	7.0		7.0	7.0	
Lane Util. Factor	1.00	0.91	1.00	1.00	0.95	1.00	1.00	1.00		1.00	1.00	
Fr _t	1.00	1.00	0.85	1.00	1.00	0.85	1.00	0.94		1.00	0.98	
Fl _t Protected	0.95	1.00	1.00	0.95	1.00	1.00	0.95	1.00		0.95	1.00	
Satd. Flow (prot)	1404	4663	1358	1546	3245	1346	1504	1739		1546	1822	
Fl _t Permitted	0.23	1.00	1.00	0.34	1.00	1.00	0.70	1.00		0.19	1.00	
Satd. Flow (perm)	335	4663	1358	545	3245	1346	1114	1739		312	1822	
Peak-hour factor, PHF	0.97	0.97	0.97	0.97	0.97	0.97	0.97	0.97	0.97	0.97	0.97	0.97
Adj. Flow (vph)	10	807	20	139	933	43	61	308	179	11	70	12
RTOR Reduction (vph)	0	0	9	0	0	20	0	20	0	0	6	0
Lane Group Flow (vph)	10	807	11	139	933	23	61	467	0	11	76	0
Heavy Vehicles (%)	20%	10%	11%	9%	10%	12%	12%	1%	4%	9%	1%	0%
Turn Type	pm+pt	NA	Perm	Perm	NA	Perm	Perm	NA		Perm	NA	
Protected Phases	5	2			6			4			8	
Permitted Phases	2		2	6		6	4			8		
Actuated Green, G (s)	67.3	67.3	67.3	62.9	62.9	62.9	38.4	38.4		38.4	38.4	
Effective Green, g (s)	67.3	67.3	67.3	62.9	62.9	62.9	38.4	38.4		38.4	38.4	
Actuated g/C Ratio	0.56	0.56	0.56	0.52	0.52	0.52	0.32	0.32		0.32	0.32	
Clearance Time (s)	3.0	7.3	7.3	7.3	7.3	7.3	7.0	7.0		7.0	7.0	
Vehicle Extension (s)	3.0	3.0	3.0	3.0	3.0	3.0	3.0	3.0		3.0	3.0	
Lane Grp Cap (vph)	200	2615	761	285	1700	705	356	556		99	583	
v/s Ratio Prot	0.00	c0.17			c0.29			c0.27			0.04	
v/s Ratio Perm	0.03		0.01	0.26		0.02	0.05			0.04		
v/c Ratio	0.05	0.31	0.01	0.49	0.55	0.03	0.17	0.84		0.11	0.13	
Uniform Delay, d ₁	12.9	14.0	11.7	18.3	19.1	13.8	29.4	37.9		28.8	28.9	
Progression Factor	1.00	1.00	1.00	1.00	1.00	1.00	1.00	1.00		0.97	0.93	
Incremental Delay, d ₂	0.1	0.3	0.0	5.9	1.3	0.1	0.2	10.7		0.5	0.1	
Delay (s)	13.0	14.3	11.7	24.1	20.4	13.9	29.6	48.6		28.3	26.9	
Level of Service	B	B	B	C	C	B	C	D		C	C	
Approach Delay (s)		14.2			20.6			46.5			27.1	
Approach LOS		B			C			D			C	

Intersection Summary

HCM 2000 Control Delay	24.2	HCM 2000 Level of Service	C
HCM 2000 Volume to Capacity ratio	0.66		
Actuated Cycle Length (s)	120.0	Sum of lost time (s)	17.3
Intersection Capacity Utilization	70.8%	ICU Level of Service	C
Analysis Period (min)	15		

c Critical Lane Group

Queues
4: Coleraine Drive & Mayfield Road

Future Background (2033) - Optimized
PM Peak Hour



Lane Group	EBL	EBT	WBL	WBT	NBL	NBT	SBL	SBT
Lane Configurations	↶	↶↷	↶	↶↷	↶	↶↷	↶	↶↷
Traffic Volume (vph)	259	699	13	647	52	338	52	201
Future Volume (vph)	259	699	13	647	52	338	52	201
Lane Group Flow (vph)	273	767	14	764	55	378	55	486
Turn Type	pm+pt	NA	Perm	NA	Perm	NA	pm+pt	NA
Protected Phases	5	2		6		4	3	8
Permitted Phases	2		6		4		8	
Detector Phase	5	2	6	6	4	4	3	8
Switch Phase								
Minimum Initial (s)	5.0	12.0	12.0	12.0	12.0	12.0	5.0	12.0
Minimum Split (s)	8.0	37.0	37.0	37.0	37.0	37.0	8.0	37.0
Total Split (s)	12.0	80.0	68.0	68.0	36.0	36.0	14.0	50.0
Total Split (%)	9.2%	61.5%	52.3%	52.3%	27.7%	27.7%	10.8%	38.5%
Yellow Time (s)	3.0	4.6	4.6	4.6	4.2	4.2	3.0	4.2
All-Red Time (s)	0.0	2.4	2.4	2.4	2.8	2.8	0.0	2.8
Lost Time Adjust (s)	0.0	0.0	0.0	0.0	0.0	0.0	0.0	0.0
Total Lost Time (s)	3.0	7.0	7.0	7.0	7.0	7.0	3.0	7.0
Lead/Lag	Lead		Lag	Lag	Lag	Lag	Lead	
Lead-Lag Optimize?	Yes		Yes	Yes	Yes	Yes	Yes	
Recall Mode	None	C-Max	C-Max	C-Max	None	None	None	None
v/c Ratio	0.64	0.34	0.04	0.44	0.45	0.73	0.32	0.54
Control Delay	16.1	10.8	19.0	21.0	61.5	60.6	39.3	20.2
Queue Delay	0.0	0.0	0.0	0.0	0.0	0.0	0.0	0.0
Total Delay	16.1	10.8	19.0	21.0	61.5	60.6	39.3	20.2
Queue Length 50th (m)	26.5	45.5	1.9	68.4	13.8	51.4	11.3	25.5
Queue Length 95th (m)	46.7	65.8	6.2	90.8	27.3	66.2	21.2	40.3
Internal Link Dist (m)		290.4		1003.7		791.2		576.8
Turn Bay Length (m)	100.0		85.0		105.0		145.0	
Base Capacity (vph)	429	2258	314	1718	187	792	185	1187
Starvation Cap Reductn	0	0	0	0	0	0	0	0
Spillback Cap Reductn	0	0	0	0	0	0	0	0
Storage Cap Reductn	0	0	0	0	0	0	0	0
Reduced v/c Ratio	0.64	0.34	0.04	0.44	0.29	0.48	0.30	0.41

Intersection Summary

Cycle Length: 130
 Actuated Cycle Length: 130
 Offset: 116 (89%), Referenced to phase 2:EBTL and 6:WBTL, Start of Green
 Natural Cycle: 90
 Control Type: Actuated-Coordinated





















Splits and Phases: 4: Coleraine Drive & Mayfield Road



HCM Signalized Intersection Capacity Analysis

4: Coleraine Drive & Mayfield Road

Future Background (2033) - Optimized
PM Peak Hour

												
Movement	EBL	EBT	EBR	WBL	WBT	WBR	NBL	NBT	NBR	SBL	SBT	SBR
Lane Configurations												
Traffic Volume (vph)	259	699	29	13	647	79	52	338	21	52	201	260
Future Volume (vph)	259	699	29	13	647	79	52	338	21	52	201	260
Ideal Flow (vphpl)	1900	1900	1900	1900	1900	1900	1900	1900	1900	1900	1900	1900
Lane Width	3.0	3.5	3.0	3.0	3.5	3.0	3.0	3.5	3.0	3.0	3.5	3.0
Total Lost time (s)	3.0	7.0		7.0	7.0		7.0	7.0		3.0	7.0	
Lane Util. Factor	1.00	0.95		1.00	0.95		1.00	0.95		1.00	0.95	
Flt	1.00	0.99		1.00	0.98		1.00	0.99		1.00	0.92	
Flt Protected	0.95	1.00		0.95	1.00		0.95	1.00		0.95	1.00	
Satd. Flow (prot)	1465	3386		1560	3230		1685	3539		1348	3045	
Flt Permitted	0.29	1.00		0.36	1.00		0.48	1.00		0.29	1.00	
Satd. Flow (perm)	451	3386		593	3230		842	3539		415	3045	
Peak-hour factor, PHF	0.95	0.95	0.95	0.95	0.95	0.95	0.95	0.95	0.95	0.95	0.95	0.95
Adj. Flow (vph)	273	736	31	14	681	83	55	356	22	55	212	274
RTOR Reduction (vph)	0	2	0	0	7	0	0	3	0	0	208	0
Lane Group Flow (vph)	273	765	0	14	757	0	55	375	0	55	278	0
Heavy Vehicles (%)	15%	5%	0%	8%	7%	23%	0%	0%	0%	25%	0%	13%
Turn Type	pm+pt	NA		Perm	NA		Perm	NA		pm+pt	NA	
Protected Phases	5	2			6			4		3	8	
Permitted Phases	2			6			4			8		
Actuated Green, G (s)	86.1	86.1		68.3	68.3		19.0	19.0		29.9	29.9	
Effective Green, g (s)	86.1	86.1		68.3	68.3		19.0	19.0		29.9	29.9	
Actuated g/C Ratio	0.66	0.66		0.53	0.53		0.15	0.15		0.23	0.23	
Clearance Time (s)	3.0	7.0		7.0	7.0		7.0	7.0		3.0	7.0	
Vehicle Extension (s)	3.0	3.0		3.0	3.0		3.0	3.0		3.0	3.0	
Lane Grp Cap (vph)	414	2242		311	1696		123	517		152	700	
v/s Ratio Prot	c0.08	0.23			0.23			c0.11		0.02	c0.09	
v/s Ratio Perm	c0.36			0.02			0.07			0.06		
v/c Ratio	0.66	0.34		0.05	0.45		0.45	0.72		0.36	0.40	
Uniform Delay, d1	10.5	9.6		15.0	19.1		50.7	53.0		40.6	42.4	
Progression Factor	1.00	1.00		1.00	1.00		1.00	1.00		1.00	1.00	
Incremental Delay, d2	3.8	0.4		0.3	0.9		2.6	5.0		1.5	0.4	
Delay (s)	14.3	10.0		15.3	20.0		53.3	58.0		42.0	42.8	
Level of Service	B	A		B	B		D	E		D	D	
Approach Delay (s)		11.1			19.9			57.4			42.7	
Approach LOS		B			B			E			D	
Intersection Summary												
HCM 2000 Control Delay			26.9				HCM 2000 Level of Service				C	
HCM 2000 Volume to Capacity ratio			0.67									
Actuated Cycle Length (s)			130.0				Sum of lost time (s)			20.0		
Intersection Capacity Utilization			79.5%				ICU Level of Service			D		
Analysis Period (min)			15									

c Critical Lane Group

Queues

5: Coleraine Drive & Private Access/George Bolton Parkway



Lane Group	EBL	EBT	WBL	WBT	NBL	NBT	SBL	SBT	SBR
Lane Configurations	↖	↗	↖	↗	↖	↗	↖	↗	↗
Traffic Volume (vph)	7	26	61	9	6	590	145	499	1
Future Volume (vph)	7	26	61	9	6	590	145	499	1
Lane Group Flow (vph)	8	58	73	198	7	795	175	601	1
Turn Type	Perm	NA	Perm	NA	Perm	NA	Perm	NA	Perm
Protected Phases		8		4		6		2	
Permitted Phases	8		4		6		2		2
Detector Phase	8	8	4	4	6	6	2	2	2
Switch Phase									
Minimum Initial (s)	8.0	8.0	12.0	12.0	12.0	12.0	12.0	12.0	12.0
Minimum Split (s)	32.5	32.5	32.5	32.5	34.2	34.2	33.7	33.7	33.7
Total Split (s)	45.0	45.0	45.0	45.0	55.0	55.0	55.0	55.0	55.0
Total Split (%)	45.0%	45.0%	45.0%	45.0%	55.0%	55.0%	55.0%	55.0%	55.0%
Yellow Time (s)	4.0	4.0	4.0	4.0	4.2	4.2	4.2	4.2	4.2
All-Red Time (s)	3.5	3.5	3.5	3.5	2.5	2.5	2.5	2.5	2.5
Lost Time Adjust (s)	0.0	0.0	0.0	0.0	0.0	0.0	0.0	0.0	0.0
Total Lost Time (s)	7.5	7.5	7.5	7.5	6.7	6.7	6.7	6.7	6.7
Lead/Lag									
Lead-Lag Optimize?									
Recall Mode	None	None	None	None	C-Max	C-Max	C-Max	C-Max	C-Max
v/c Ratio	0.07	0.24	0.48	0.59	0.02	0.35	0.42	0.26	0.00
Control Delay	37.4	25.7	50.0	18.0	4.8	5.8	9.8	5.3	0.0
Queue Delay	0.0	0.0	0.0	0.0	0.0	0.0	0.0	0.0	0.0
Total Delay	37.4	25.7	50.0	18.0	4.8	5.8	9.8	5.3	0.0
Queue Length 50th (m)	1.5	5.8	14.2	7.7	0.3	24.5	11.3	17.5	0.0
Queue Length 95th (m)	5.3	14.8	24.9	23.1	1.7	36.8	26.2	27.3	0.0
Internal Link Dist (m)		152.4		468.8		784.9		1711.9	
Turn Bay Length (m)	70.0		105.0		75.0		100.0		100.0
Base Capacity (vph)	322	619	423	656	362	2264	417	2280	1101
Starvation Cap Reductn	0	0	0	0	0	0	0	0	0
Spillback Cap Reductn	0	0	0	0	0	0	0	0	0
Storage Cap Reductn	0	0	0	0	0	0	0	0	0
Reduced v/c Ratio	0.02	0.09	0.17	0.30	0.02	0.35	0.42	0.26	0.00

Intersection Summary

Cycle Length: 100

Actuated Cycle Length: 100

Offset: 0 (0%), Referenced to phase 2:SBTL and 6:NBTL, Start of Green

Natural Cycle: 70

Control Type: Actuated-Coordinated

Splits and Phases: 5: Coleraine Drive & Private Access/George Bolton Parkway

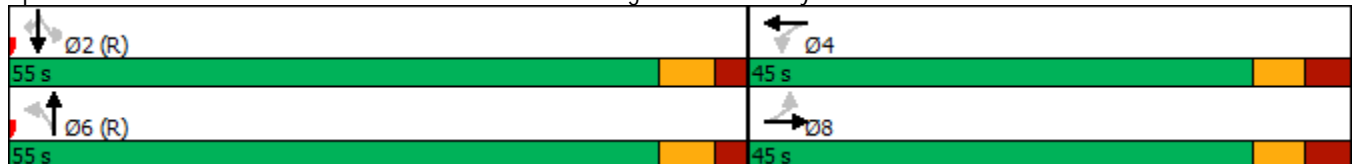

HCM Signalized Intersection Capacity Analysis

Future Background (2033) - Optimized

5: Coleraine Drive & Private Access/George Bolton Parkway

PM Peak Hour



Movement	EBL	EBT	EBR	WBL	WBT	WBR	NBL	NBT	NBR	SBL	SBT	SBR
Lane Configurations	↖	↗		↖	↗		↖	↕		↖	↕	↗
Traffic Volume (vph)	7	26	22	61	9	155	6	590	70	145	499	1
Future Volume (vph)	7	26	22	61	9	155	6	590	70	145	499	1
Ideal Flow (vphpl)	1900	1900	1900	1900	1900	1900	1900	1900	1900	1900	1900	1900
Lane Width	3.0	3.5	3.0	3.0	3.5	3.0	3.0	3.5	3.0	3.0	3.5	3.0
Total Lost time (s)	7.5	7.5		7.5	7.5		6.7	6.7		6.7	6.7	6.7
Lane Util. Factor	1.00	1.00		1.00	1.00		1.00	0.95		1.00	0.95	1.00
Frt	1.00	0.93		1.00	0.86		1.00	0.98		1.00	1.00	0.85
Flt Protected	0.95	1.00		0.95	1.00		0.95	1.00		0.95	1.00	1.00
Satd. Flow (prot)	1685	1608		1491	1491		1123	3131		1604	3159	1507
Flt Permitted	0.49	1.00		0.72	1.00		0.42	1.00		0.34	1.00	1.00
Satd. Flow (perm)	861	1608		1129	1491		502	3131		579	3159	1507
Peak-hour factor, PHF	0.83	0.83	0.83	0.83	0.83	0.83	0.83	0.83	0.83	0.83	0.83	0.83
Adj. Flow (vph)	8	31	27	73	11	187	7	711	84	175	601	1
RTOR Reduction (vph)	0	23	0	0	136	0	0	5	0	0	0	0
Lane Group Flow (vph)	8	35	0	73	62	0	7	790	0	175	601	1
Heavy Vehicles (%)	0%	4%	14%	13%	11%	8%	50%	12%	14%	5%	13%	0%
Turn Type	Perm	NA		Perm	NA		Perm	NA		Perm	NA	Perm
Protected Phases		8			4			6			2	
Permitted Phases	8			4			6			2		2
Actuated Green, G (s)	13.6	13.6		13.6	13.6		72.2	72.2		72.2	72.2	72.2
Effective Green, g (s)	13.6	13.6		13.6	13.6		72.2	72.2		72.2	72.2	72.2
Actuated g/C Ratio	0.14	0.14		0.14	0.14		0.72	0.72		0.72	0.72	0.72
Clearance Time (s)	7.5	7.5		7.5	7.5		6.7	6.7		6.7	6.7	6.7
Vehicle Extension (s)	3.0	3.0		3.0	3.0		3.0	3.0		3.0	3.0	3.0
Lane Grp Cap (vph)	117	218		153	202		362	2260		418	2280	1088
v/s Ratio Prot		0.02			0.04			0.25			0.19	
v/s Ratio Perm	0.01			c0.06			0.01			c0.30		0.00
v/c Ratio	0.07	0.16		0.48	0.31		0.02	0.35		0.42	0.26	0.00
Uniform Delay, d1	37.7	38.1		39.9	39.0		3.9	5.2		5.5	4.8	3.9
Progression Factor	1.00	1.00		1.00	1.00		1.00	1.00		1.00	1.00	1.00
Incremental Delay, d2	0.2	0.3		2.3	0.9		0.1	0.4		3.1	0.3	0.0
Delay (s)	37.9	38.5		42.3	39.8		4.0	5.6		8.6	5.1	3.9
Level of Service	D	D		D	D		A	A		A	A	A
Approach Delay (s)		38.4			40.5			5.6			5.9	
Approach LOS		D			D			A			A	

Intersection Summary

HCM 2000 Control Delay	11.8	HCM 2000 Level of Service	B
HCM 2000 Volume to Capacity ratio	0.43		
Actuated Cycle Length (s)	100.0	Sum of lost time (s)	14.2
Intersection Capacity Utilization	56.0%	ICU Level of Service	B
Analysis Period (min)	15		

c Critical Lane Group

Queues

6: Highway 50 & George Bolton Parkway/Private Access



Lane Group	EBL	EBT	WBL	WBT	NBL	NBT	SBL	SBT	SBR
Lane Configurations	↖	↗		↕	↖	↗	↖	↕	↗
Traffic Volume (vph)	209	0	5	0	142	1393	1	988	169
Future Volume (vph)	209	0	5	0	142	1393	1	988	169
Lane Group Flow (vph)	218	201	0	12	148	1451	1	1029	176
Turn Type	Perm	NA	Perm	NA	pm+pt	NA	Perm	NA	Perm
Protected Phases		8		4	1	6		2	
Permitted Phases	8		4		6		2		2
Detector Phase	8	8	4	4	1	6	2	2	2
Switch Phase									
Minimum Initial (s)	8.0	8.0	8.0	8.0	5.0	12.0	12.0	12.0	12.0
Minimum Split (s)	32.6	32.6	32.6	32.6	8.0	27.3	27.3	27.3	27.3
Total Split (s)	35.0	35.0	35.0	35.0	10.0	85.0	75.0	75.0	75.0
Total Split (%)	29.2%	29.2%	29.2%	29.2%	8.3%	70.8%	62.5%	62.5%	62.5%
Yellow Time (s)	4.0	4.0	4.0	4.0	3.0	4.0	4.0	4.0	4.0
All-Red Time (s)	2.6	2.6	2.6	2.6	0.0	2.3	2.3	2.3	2.3
Lost Time Adjust (s)	0.0	0.0		0.0	0.0	0.0	0.0	0.0	0.0
Total Lost Time (s)	6.6	6.6		6.6	3.0	6.3	6.3	6.3	6.3
Lead/Lag					Lead		Lag	Lag	Lag
Lead-Lag Optimize?					Yes		Yes	Yes	Yes
Recall Mode	None	None	None	None	None	C-Max	C-Max	C-Max	C-Max
v/c Ratio	0.83	0.47		0.03	0.49	0.61	0.01	0.49	0.19
Control Delay	70.6	9.9		0.2	11.6	11.7	11.0	14.9	2.2
Queue Delay	0.0	0.0		0.0	0.0	0.0	0.0	0.0	0.0
Total Delay	70.6	9.9		0.2	11.6	11.7	11.0	14.9	2.2
Queue Length 50th (m)	51.6	1.8		0.0	10.5	93.7	0.1	76.0	0.0
Queue Length 95th (m)	#79.3	21.8		0.0	19.8	125.8	0.9	95.5	9.7
Internal Link Dist (m)		846.5		43.0		1045.6		1307.8	
Turn Bay Length (m)	85.0				40.0		135.0		60.0
Base Capacity (vph)	314	479		404	302	2383	168	2099	943
Starvation Cap Reductn	0	0		0	0	0	0	0	0
Spillback Cap Reductn	0	0		0	0	0	0	0	0
Storage Cap Reductn	0	0		0	0	0	0	0	0
Reduced v/c Ratio	0.69	0.42		0.03	0.49	0.61	0.01	0.49	0.19

Intersection Summary

Cycle Length: 120
 Actuated Cycle Length: 120
 Offset: 116 (97%), Referenced to phase 2:SBTL and 6:NBTL, Start of Green
 Natural Cycle: 70
 Control Type: Actuated-Coordinated
 # 95th percentile volume exceeds capacity, queue may be longer.
 Queue shown is maximum after two cycles.

Splits and Phases: 6: Highway 50 & George Bolton Parkway/Private Access

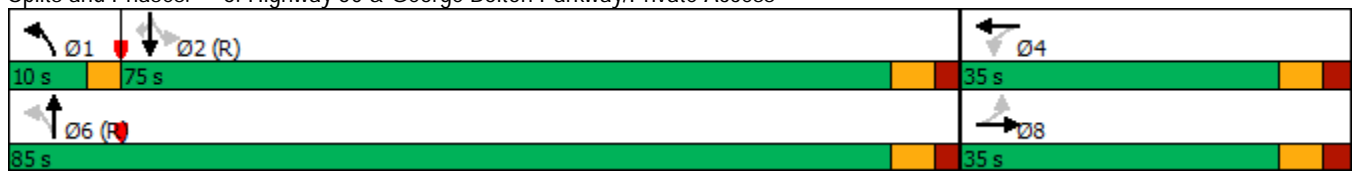

HCM Signalized Intersection Capacity Analysis
6: Highway 50 & George Bolton Parkway/Private Access

Future Background (2033) - Optimized
PM Peak Hour



Movement	EBL	EBT	EBR	WBL	WBT	WBR	NBL	NBT	NBR	SBL	SBT	SBR
Lane Configurations	↖	↗			↔		↖	↕		↖	↗	↗
Traffic Volume (vph)	209	0	193	5	0	7	142	1393	0	1	988	169
Future Volume (vph)	209	0	193	5	0	7	142	1393	0	1	988	169
Ideal Flow (vphpl)	1900	1900	1900	1900	1900	1900	1900	1900	1900	1900	1900	1900
Lane Width	3.0	3.5	3.0	3.0	3.5	3.0	3.0	3.5	3.0	3.0	3.5	3.0
Total Lost time (s)	6.6	6.6			6.6		3.0	6.3		6.3	6.3	6.3
Lane Util. Factor	1.00	1.00			1.00		1.00	0.95		1.00	0.95	1.00
Frbp, ped/bikes	1.00	0.99			1.00		1.00	1.00		1.00	1.00	0.98
Flpb, ped/bikes	1.00	1.00			1.00		1.00	1.00		1.00	1.00	1.00
Frt	1.00	0.85			0.92		1.00	1.00		1.00	1.00	0.85
Flt Protected	0.95	1.00			0.98		0.95	1.00		0.95	1.00	1.00
Satd. Flow (prot)	1685	1405			1694		1416	3433		1685	3466	1444
Flt Permitted	0.75	1.00			0.88		0.22	1.00		0.16	1.00	1.00
Satd. Flow (perm)	1330	1405			1526		321	3433		278	3466	1444
Peak-hour factor, PHF	0.96	0.96	0.96	0.96	0.96	0.96	0.96	0.96	0.96	0.96	0.96	0.96
Adj. Flow (vph)	218	0	201	5	0	7	148	1451	0	1	1029	176
RTOR Reduction (vph)	0	154	0	0	10	0	0	0	0	0	0	69
Lane Group Flow (vph)	218	47	0	0	2	0	148	1451	0	1	1029	107
Confl. Peds. (#/hr)			2	2			1					1
Heavy Vehicles (%)	0%	0%	12%	0%	0%	0%	19%	4%	0%	0%	3%	2%
Turn Type	Perm	NA		Perm	NA		pm+pt	NA		Perm	NA	Perm
Protected Phases		8			4		1	6			2	
Permitted Phases	8			4			6			2		2
Actuated Green, G (s)	23.8	23.8			23.8		83.3	83.3		72.7	72.7	72.7
Effective Green, g (s)	23.8	23.8			23.8		83.3	83.3		72.7	72.7	72.7
Actuated g/C Ratio	0.20	0.20			0.20		0.69	0.69		0.61	0.61	0.61
Clearance Time (s)	6.6	6.6			6.6		3.0	6.3		6.3	6.3	6.3
Vehicle Extension (s)	3.0	3.0			3.0		3.0	3.0		3.0	3.0	3.0
Lane Grp Cap (vph)	263	278			302		292	2383		168	2099	874
v/s Ratio Prot		0.03					0.03	c0.42			0.30	
v/s Ratio Perm	c0.16				0.00		0.32			0.00		0.07
v/c Ratio	0.83	0.17			0.01		0.51	0.61		0.01	0.49	0.12
Uniform Delay, d1	46.1	39.9			38.6		8.2	9.7		9.4	13.3	10.1
Progression Factor	1.00	1.00			1.00		1.00	1.00		1.00	1.00	1.00
Incremental Delay, d2	18.9	0.3			0.0		1.4	1.2		0.1	0.8	0.3
Delay (s)	65.1	40.2			38.6		9.5	10.9		9.4	14.1	10.4
Level of Service	E	D			D		A	B		A	B	B
Approach Delay (s)		53.1			38.6			10.8			13.5	
Approach LOS		D			D			B			B	

Intersection Summary

HCM 2000 Control Delay	17.4	HCM 2000 Level of Service	B
HCM 2000 Volume to Capacity ratio	0.68		
Actuated Cycle Length (s)	120.0	Sum of lost time (s)	15.9
Intersection Capacity Utilization	83.0%	ICU Level of Service	E
Analysis Period (min)	15		
c Critical Lane Group			

Queues
 9: Humber Station Road & Subject Lands Site Access #1

Future Background (2033) - Optimized
 PM Peak Hour

	↑	↓	
Lane Group	NBT	SBT	Ø8
Lane Configurations	↑	↑	
Traffic Volume (vph)	351	91	
Future Volume (vph)	351	91	
Lane Group Flow (vph)	351	91	
Turn Type	NA	NA	
Protected Phases	2	6	8
Permitted Phases			
Detector Phase	2	6	
Switch Phase			
Minimum Initial (s)	12.0	12.0	12.0
Minimum Split (s)	24.7	24.7	25.5
Total Split (s)	61.0	61.0	59.0
Total Split (%)	50.8%	50.8%	49%
Yellow Time (s)	4.2	4.2	4.0
All-Red Time (s)	2.5	2.5	3.5
Lost Time Adjust (s)	0.0	0.0	
Total Lost Time (s)	6.7	6.7	
Lead/Lag			
Lead-Lag Optimize?			
Recall Mode	C-Max	C-Max	None
v/c Ratio	0.19	0.05	
Control Delay	0.2	0.1	
Queue Delay	0.0	0.0	
Total Delay	0.2	0.1	
Queue Length 50th (m)	0.0	0.0	
Queue Length 95th (m)	0.0	0.0	
Internal Link Dist (m)	1542.4	460.2	
Turn Bay Length (m)			
Base Capacity (vph)	1824	1842	
Starvation Cap Reductn	0	0	
Spillback Cap Reductn	0	0	
Storage Cap Reductn	0	0	
Reduced v/c Ratio	0.19	0.05	

Intersection Summary





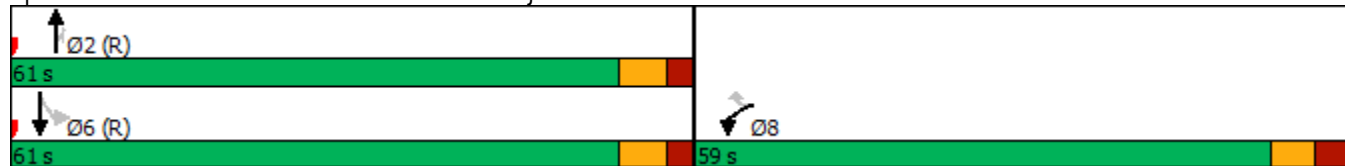







Cycle Length: 120
 Actuated Cycle Length: 120
 Offset: 0 (0%), Referenced to phase 2:NBT and 6:SBTL, Start of Green
 Natural Cycle: 55
 Control Type: Actuated-Coordinated

Splits and Phases: 9: Humber Station Road & Subject Lands Site Access #1



HCM Signalized Intersection Capacity Analysis
 9: Humber Station Road & Subject Lands Site Access #1

Future Background (2033) - Optimized
 PM Peak Hour

						
Movement	WBL	WBR	NBT	NBR	SBL	SBT
Lane Configurations						
Traffic Volume (vph)	0	0	351	0	0	91
Future Volume (vph)	0	0	351	0	0	91
Ideal Flow (vphpl)	1900	1900	1900	1900	1900	1900
Lane Width	3.0	3.0	3.5	3.0	3.0	3.5
Total Lost time (s)			6.7			6.7
Lane Util. Factor			1.00			1.00
Frt			1.00			1.00
Flt Protected			1.00			1.00
Satd. Flow (prot)			1824			1842
Flt Permitted			1.00			1.00
Satd. Flow (perm)			1824			1842
Peak-hour factor, PHF	1.00	1.00	1.00	1.00	1.00	1.00
Adj. Flow (vph)	0	0	351	0	0	91
RTOR Reduction (vph)	0	0	0	0	0	0
Lane Group Flow (vph)	0	0	351	0	0	91
Heavy Vehicles (%)	0%	0%	3%	0%	0%	2%
Turn Type	Prot	Perm	NA	Perm	Perm	NA
Protected Phases	8		2			6
Permitted Phases		8		2	6	
Actuated Green, G (s)			120.0			120.0
Effective Green, g (s)			120.0			120.0
Actuated g/C Ratio			1.00			1.00
Clearance Time (s)			6.7			6.7
Vehicle Extension (s)			3.0			3.0
Lane Grp Cap (vph)			1824			1842
v/s Ratio Prot			c0.19			0.05
v/s Ratio Perm						
v/c Ratio			0.19			0.05
Uniform Delay, d1			0.0			0.0
Progression Factor			1.00			1.00
Incremental Delay, d2			0.2			0.1
Delay (s)			0.2			0.1
Level of Service			A			A
Approach Delay (s)	0.0		0.2			0.1
Approach LOS	A		A			A
Intersection Summary						
HCM 2000 Control Delay			0.2		HCM 2000 Level of Service	A
HCM 2000 Volume to Capacity ratio			0.22			
Actuated Cycle Length (s)			120.0		Sum of lost time (s)	14.2
Intersection Capacity Utilization			24.1%		ICU Level of Service	A
Analysis Period (min)			15			
c Critical Lane Group						

HCM Unsignalized Intersection Capacity Analysis
 24: Mayfield Road & Triangle Lands



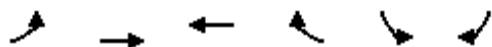









Future Background (2033) - Optimized
 PM Peak Hour



Movement	EBL	EBT	WBT	WBR	SBL	SBR	
Lane Configurations							
Traffic Volume (veh/h)	85	883	915	57	75	167	
Future Volume (Veh/h)	85	883	915	57	75	167	
Sign Control		Free	Free		Stop		
Grade		0%	0%		0%		
Peak Hour Factor	1.00	1.00	1.00	1.00	1.00	1.00	
Hourly flow rate (vph)	85	883	915	57	75	167	
Pedestrians							
Lane Width (m)							
Walking Speed (m/s)							
Percent Blockage							
Right turn flare (veh)							
Median type		None	None				
Median storage (veh)							
Upstream signal (m)			314				
pX, platoon unblocked	0.88				0.88	0.88	
vC, conflicting volume	972				1555	486	
vC1, stage 1 conf vol							
vC2, stage 2 conf vol							
vCu, unblocked vol	695				1357	142	
tC, single (s)	4.4				7.1	7.2	
tC, 2 stage (s)							
tF (s)	2.3				3.6	3.4	
p0 queue free %	88				23	77	
cM capacity (veh/h)	722				97	742	
Direction, Lane #	EB 1	EB 2	EB 3	WB 1	WB 2	SB 1	SB 2
Volume Total	85	442	442	610	362	75	167
Volume Left	85	0	0	0	0	75	0
Volume Right	0	0	0	0	57	0	167
cSH	722	1700	1700	1700	1700	97	742
Volume to Capacity	0.12	0.26	0.26	0.36	0.21	0.77	0.23
Queue Length 95th (m)	3.2	0.0	0.0	0.0	0.0	32.9	6.9
Control Delay (s)	10.6	0.0	0.0	0.0	0.0	115.8	11.3
Lane LOS	B					F	B
Approach Delay (s)	0.9			0.0		43.7	
Approach LOS						E	
Intersection Summary							
Average Delay			5.3				
Intersection Capacity Utilization			46.0%		ICU Level of Service		A
Analysis Period (min)			15				

HCM Unsignalized Intersection Capacity Analysis
 26: Humber Station Road & Subject Lands Site Access #3

Future Background (2033) - Optimized
 PM Peak Hour

						
Movement	WBL	WBR	NBT	NBR	SBL	SBT
Lane Configurations						
Traffic Volume (veh/h)	0	0	351	0	0	91
Future Volume (Veh/h)	0	0	351	0	0	91
Sign Control	Stop		Free		Free	
Grade	0%		0%		0%	
Peak Hour Factor	1.00	1.00	1.00	1.00	1.00	1.00
Hourly flow rate (vph)	0	0	351	0	0	91
Pedestrians						
Lane Width (m)						
Walking Speed (m/s)						
Percent Blockage						
Right turn flare (veh)						
Median type			None		None	
Median storage veh						
Upstream signal (m)						
pX, platoon unblocked						
vC, conflicting volume	442	351			351	
vC1, stage 1 conf vol						
vC2, stage 2 conf vol						
vCu, unblocked vol	442	351			351	
tC, single (s)	6.4	6.2			4.1	
tC, 2 stage (s)						
tF (s)	3.5	3.3			2.2	
p0 queue free %	100	100			100	
cM capacity (veh/h)	577	697			1219	
Direction, Lane #	WB 1	WB 2	NB 1	NB 2	SB 1	SB 2
Volume Total	0	0	351	0	0	91
Volume Left	0	0	0	0	0	0
Volume Right	0	0	0	0	0	0
cSH	1700	1700	1700	1700	1700	1700
Volume to Capacity	0.00	0.00	0.21	0.00	0.00	0.05
Queue Length 95th (m)	0.0	0.0	0.0	0.0	0.0	0.0
Control Delay (s)	0.0	0.0	0.0	0.0	0.0	0.0
Lane LOS	A	A				
Approach Delay (s)	0.0		0.0		0.0	
Approach LOS	A					
Intersection Summary						
Average Delay			0.0			
Intersection Capacity Utilization			21.8%		ICU Level of Service	A
Analysis Period (min)			15			

HCM Unsignalized Intersection Capacity Analysis
 27: Subject Lands Site Access #4 & Healey Road













Future Background (2033) - Optimized
 PM Peak Hour



Movement	EBT	EBR	WBL	WBT	NBL	NBR
Lane Configurations	↻			↻	↻	↻
Traffic Volume (veh/h)	456	0	0	812	0	0
Future Volume (Veh/h)	456	0	0	812	0	0
Sign Control	Free			Free	Stop	
Grade	0%			0%	0%	
Peak Hour Factor	1.00	1.00	1.00	1.00	1.00	1.00
Hourly flow rate (vph)	456	0	0	812	0	0
Pedestrians						
Lane Width (m)						
Walking Speed (m/s)						
Percent Blockage						
Right turn flare (veh)						
Median type	None			None		
Median storage veh)						
Upstream signal (m)						
pX, platoon unblocked						
vC, conflicting volume			456		1268	456
vC1, stage 1 conf vol						
vC2, stage 2 conf vol						
vCu, unblocked vol			456		1268	456
tC, single (s)			4.1		6.4	6.2
tC, 2 stage (s)						
tF (s)			2.2		3.5	3.3
p0 queue free %			100		100	100
cM capacity (veh/h)			1115		188	609
Direction, Lane #	EB 1	WB 1	NB 1	NB 2		
Volume Total	456	812	0	0		
Volume Left	0	0	0	0		
Volume Right	0	0	0	0		
cSH	1700	1115	1700	1700		
Volume to Capacity	0.27	0.00	0.00	0.00		
Queue Length 95th (m)	0.0	0.0	0.0	0.0		
Control Delay (s)	0.0	0.0	0.0	0.0		
Lane LOS			A	A		
Approach Delay (s)	0.0	0.0	0.0			
Approach LOS			A			
Intersection Summary						
Average Delay			0.0			
Intersection Capacity Utilization			46.1%	ICU Level of Service	A	
Analysis Period (min)			15			

HCM Unsignalized Intersection Capacity Analysis
 28: Humber Station Road & Subject Lands Site Access #2

Future Background (2033) - Optimized
 PM Peak Hour

						
Movement	WBL	WBR	NBT	NBR	SBL	SBT
Lane Configurations						
Traffic Volume (veh/h)	0	0	351	0	0	91
Future Volume (Veh/h)	0	0	351	0	0	91
Sign Control	Stop		Free		Free	
Grade	0%		0%		0%	
Peak Hour Factor	1.00	1.00	1.00	1.00	1.00	1.00
Hourly flow rate (vph)	0	0	351	0	0	91
Pedestrians						
Lane Width (m)						
Walking Speed (m/s)						
Percent Blockage						
Right turn flare (veh)						
Median type			None		None	
Median storage veh						
Upstream signal (m)						
pX, platoon unblocked						
vC, conflicting volume	442	351			351	
vC1, stage 1 conf vol						
vC2, stage 2 conf vol						
vCu, unblocked vol	442	351			351	
tC, single (s)	6.4	6.2			4.1	
tC, 2 stage (s)						
tF (s)	3.5	3.3			2.2	
p0 queue free %	100	100			100	
cM capacity (veh/h)	577	697			1219	
Direction, Lane #	WB 1	WB 2	NB 1	NB 2	SB 1	SB 2
Volume Total	0	0	351	0	0	91
Volume Left	0	0	0	0	0	0
Volume Right	0	0	0	0	0	0
cSH	1700	1700	1700	1700	1700	1700
Volume to Capacity	0.00	0.00	0.21	0.00	0.00	0.05
Queue Length 95th (m)	0.0	0.0	0.0	0.0	0.0	0.0
Control Delay (s)	0.0	0.0	0.0	0.0	0.0	0.0
Lane LOS	A	A				
Approach Delay (s)	0.0		0.0		0.0	
Approach LOS	A					
Intersection Summary						
Average Delay			0.0			
Intersection Capacity Utilization			21.8%		ICU Level of Service	A
Analysis Period (min)			15			

HCM Unsignalized Intersection Capacity Analysis
 29: Mayfield Road & Subject Lands Site Access #5

Future Background (2033) - Optimized
 PM Peak Hour

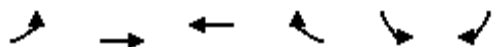

Movement	EBL	EBT	WBT	WBR	SBL	SBR	
Lane Configurations	↘	↑↑	↑↑		↘	↗	
Traffic Volume (veh/h)	0	968	1082	0	0	0	
Future Volume (Veh/h)	0	968	1082	0	0	0	
Sign Control		Free	Free		Stop		
Grade		0%	0%		0%		
Peak Hour Factor	1.00	1.00	1.00	1.00	1.00	1.00	
Hourly flow rate (vph)	0	968	1082	0	0	0	
Pedestrians							
Lane Width (m)							
Walking Speed (m/s)							
Percent Blockage							
Right turn flare (veh)							
Median type		None	None				
Median storage (veh)							
Upstream signal (m)		266					
pX, platoon unblocked					0.89		
vC, conflicting volume	1082				1566	541	
vC1, stage 1 conf vol							
vC2, stage 2 conf vol							
vCu, unblocked vol	1082				1391	541	
tC, single (s)	4.1				6.8	6.9	
tC, 2 stage (s)							
tF (s)	2.2				3.5	3.3	
p0 queue free %	100				100	100	
cM capacity (veh/h)	652				121	491	
Direction, Lane #	EB 1	EB 2	EB 3	WB 1	WB 2	SB 1	SB 2
Volume Total	0	484	484	721	361	0	0
Volume Left	0	0	0	0	0	0	0
Volume Right	0	0	0	0	0	0	0
cSH	1700	1700	1700	1700	1700	1700	1700
Volume to Capacity	0.00	0.28	0.28	0.42	0.21	0.00	0.00
Queue Length 95th (m)	0.0	0.0	0.0	0.0	0.0	0.0	0.0
Control Delay (s)	0.0	0.0	0.0	0.0	0.0	0.0	0.0
Lane LOS						A	A
Approach Delay (s)	0.0			0.0		0.0	
Approach LOS						A	
Intersection Summary							
Average Delay			0.0				
Intersection Capacity Utilization			33.2%		ICU Level of Service		A
Analysis Period (min)			15				

Queues
1: Coleraine Drive & Healey Road

Future Background (2043) - Optimized
AM Peak Hour



Lane Group	EBL	EBT	WBL	WBT	NBL	NBT	SBL	SBT
Lane Configurations	↶	↷	↶	↷	↶	↷	↶	↷
Traffic Volume (vph)	219	536	49	221	35	168	64	324
Future Volume (vph)	219	536	49	221	35	168	64	324
Lane Group Flow (vph)	235	836	53	262	38	210	69	522
Turn Type	pm+pt	NA	pm+pt	NA	pm+pt	NA	Perm	NA
Protected Phases	3	8	7	4	1	6		2
Permitted Phases	8		4		6		2	
Detector Phase	3	8	7	4	1	6	2	2
Switch Phase								
Minimum Initial (s)	5.0	8.0	5.0	8.0	5.0	8.0	8.0	8.0
Minimum Split (s)	8.0	32.8	8.0	32.8	9.5	36.7	36.7	36.7
Total Split (s)	8.0	65.0	8.0	65.0	10.0	47.0	37.0	37.0
Total Split (%)	6.7%	54.2%	6.7%	54.2%	8.3%	39.2%	30.8%	30.8%
Yellow Time (s)	3.0	4.0	3.0	4.0	3.0	4.6	4.6	4.6
All-Red Time (s)	0.0	2.8	0.0	2.8	0.0	2.1	2.1	2.1
Lost Time Adjust (s)	0.0	0.0	0.0	0.0	0.0	0.0	0.0	0.0
Total Lost Time (s)	3.0	6.8	3.0	6.8	3.0	6.7	6.7	6.7
Lead/Lag	Lead	Lag	Lead	Lag	Lead		Lag	Lag
Lead-Lag Optimize?	Yes	Yes	Yes	Yes	Yes		Yes	Yes
Recall Mode	None	None	None	None	None	C-Max	C-Max	C-Max
v/c Ratio	0.43	0.97	0.48	0.32	0.14	0.21	0.26	0.53
Control Delay	7.6	40.7	26.4	20.5	26.0	26.4	38.6	33.8
Queue Delay	0.0	0.0	0.0	0.0	0.0	0.0	0.0	0.0
Total Delay	7.6	40.7	26.4	20.5	26.0	26.4	38.6	33.8
Queue Length 50th (m)	6.3	192.9	5.4	37.3	6.1	18.0	14.0	52.9
Queue Length 95th (m)	12.1	#278.7	12.4	56.7	14.0	28.1	28.5	72.4
Internal Link Dist (m)		823.7		424.0		1711.9		1121.0
Turn Bay Length (m)	55.0		50.0		80.0		155.0	
Base Capacity (vph)	544	870	110	841	275	984	262	979
Starvation Cap Reductn	0	0	0	0	0	0	0	0
Spillback Cap Reductn	0	0	0	0	0	0	0	0
Storage Cap Reductn	0	0	0	0	0	0	0	0
Reduced v/c Ratio	0.43	0.96	0.48	0.31	0.14	0.21	0.26	0.53

Intersection Summary





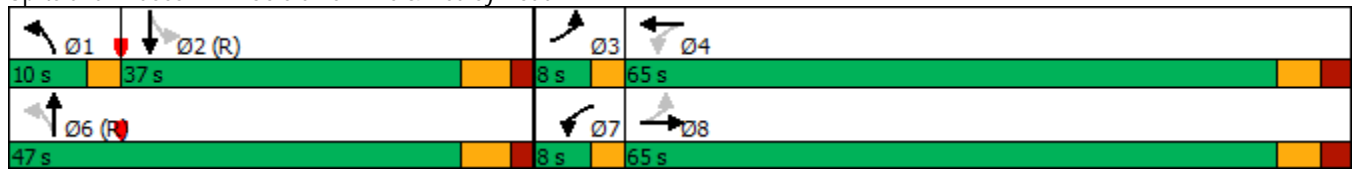

















Cycle Length: 120
 Actuated Cycle Length: 120
 Offset: 13 (11%), Referenced to phase 2:SBTL and 6:NBTL, Start of Green
 Natural Cycle: 110
 Control Type: Actuated-Coordinated
 # 95th percentile volume exceeds capacity, queue may be longer.
 Queue shown is maximum after two cycles.

Splits and Phases: 1: Coleraine Drive & Healey Road



HCM Signalized Intersection Capacity Analysis
1: Coleraine Drive & Healey Road

Future Background (2043) - Optimized
AM Peak Hour

												
Movement	EBL	EBT	EBR	WBL	WBT	WBR	NBL	NBT	NBR	SBL	SBT	SBR
Lane Configurations												
Traffic Volume (vph)	219	536	242	49	221	22	35	168	27	64	324	162
Future Volume (vph)	219	536	242	49	221	22	35	168	27	64	324	162
Ideal Flow (vphpl)	1900	1900	1900	1900	1900	1900	1900	1900	1900	1900	1900	1900
Lane Width	3.0	3.5	3.0	3.0	3.5	3.0	3.0	3.5	3.0	3.0	3.5	3.0
Total Lost time (s)	3.0	6.8		3.0	6.8		3.0	6.7		6.7	6.7	
Lane Util. Factor	1.00	1.00		1.00	1.00		1.00	0.95		1.00	0.95	
Fr _t	1.00	0.95		1.00	0.99		1.00	0.98		1.00	0.95	
Fl _t Protected	0.95	1.00		0.95	1.00		0.95	1.00		0.95	1.00	
Satd. Flow (prot)	1652	1768		1404	1730		1636	2739		1316	3046	
Fl _t Permitted	0.55	1.00		0.07	1.00		0.32	1.00		0.62	1.00	
Satd. Flow (perm)	948	1768		105	1730		547	2739		859	3046	
Peak-hour factor, PHF	0.93	0.93	0.93	0.93	0.93	0.93	0.93	0.93	0.93	0.93	0.93	0.93
Adj. Flow (vph)	235	576	260	53	238	24	38	181	29	69	348	174
RTOR Reduction (vph)	0	14	0	0	3	0	0	10	0	0	49	0
Lane Group Flow (vph)	235	822	0	53	259	0	38	200	0	69	473	0
Heavy Vehicles (%)	2%	1%	2%	20%	1%	68%	3%	29%	19%	28%	16%	2%
Turn Type	pm+pt	NA		pm+pt	NA		pm+pt	NA		Perm	NA	
Protected Phases	3	8		7	4		1	6			2	
Permitted Phases	8			4			6			2		
Actuated Green, G (s)	62.4	57.4		60.4	56.4		42.1	42.1		34.9	34.9	
Effective Green, g (s)	62.4	57.4		60.4	56.4		42.1	42.1		34.9	34.9	
Actuated g/C Ratio	0.52	0.48		0.50	0.47		0.35	0.35		0.29	0.29	
Clearance Time (s)	3.0	6.8		3.0	6.8		3.0	6.7		6.7	6.7	
Vehicle Extension (s)	3.0	3.0		3.0	3.0		3.0	3.0		3.0	3.0	
Lane Grp Cap (vph)	522	845		96	813		230	960		249	885	
v/s Ratio Prot	c0.02	c0.47		c0.02	0.15		0.01	c0.07			c0.16	
v/s Ratio Perm	0.22			0.26			0.05			0.08		
v/c Ratio	0.45	0.97		0.55	0.32		0.17	0.21		0.28	0.53	
Uniform Delay, d ₁	18.1	30.6		25.3	19.8		26.5	27.3		32.8	35.7	
Progression Factor	0.38	0.56		1.00	1.00		1.00	1.00		1.00	1.00	
Incremental Delay, d ₂	0.5	21.8		6.7	0.2		0.3	0.5		2.7	2.3	
Delay (s)	7.4	39.0		32.0	20.0		26.8	27.8		35.6	38.0	
Level of Service	A	D		C	C		C	C		D	D	
Approach Delay (s)		32.1			22.1			27.6			37.8	
Approach LOS		C			C			C			D	
Intersection Summary												
HCM 2000 Control Delay			31.7			HCM 2000 Level of Service			C			
HCM 2000 Volume to Capacity ratio			0.77									
Actuated Cycle Length (s)			120.0			Sum of lost time (s)			19.5			
Intersection Capacity Utilization			83.3%			ICU Level of Service			E			
Analysis Period (min)			15									

c Critical Lane Group

Queues
2: Humber Station Road & Healey Road

Future Background (2043) - Optimized
AM Peak Hour

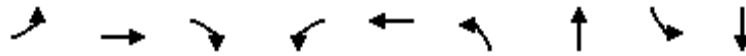

Lane Group	EBL	EBT	EBR	WBL	WBT	NBL	NBT	SBL	SBT
Lane Configurations	↖	↑	↗	↖	↗	↖	↗	↖	↗
Traffic Volume (vph)	4	943	35	73	469	23	24	78	203
Future Volume (vph)	4	943	35	73	469	23	24	78	203
Lane Group Flow (vph)	4	1014	38	78	508	25	75	84	222
Turn Type	Perm	NA	Perm	pm+pt	NA	Perm	NA	Perm	NA
Protected Phases		4		3	8		2		6
Permitted Phases	4		4	8		2		6	
Detector Phase	4	4	4	3	8	2	2	6	6
Switch Phase									
Minimum Initial (s)	8.0	8.0	8.0	5.0	8.0	8.0	8.0	5.0	5.0
Minimum Split (s)	24.8	24.8	24.8	9.5	24.8	24.7	24.7	24.8	24.8
Total Split (s)	65.0	65.0	65.0	25.0	90.0	30.0	30.0	30.0	30.0
Total Split (%)	54.2%	54.2%	54.2%	20.8%	75.0%	25.0%	25.0%	25.0%	25.0%
Yellow Time (s)	4.0	4.0	4.0	3.0	4.0	4.6	4.6	4.6	4.6
All-Red Time (s)	2.8	2.8	2.8	0.0	2.8	2.1	2.1	2.1	2.1
Lost Time Adjust (s)	0.0	0.0	0.0	0.0	0.0	0.0	0.0	0.0	0.0
Total Lost Time (s)	6.8	6.8	6.8	3.0	6.8	6.7	6.7	6.7	6.7
Lead/Lag	Lag	Lag	Lag	Lead					
Lead-Lag Optimize?	Yes	Yes	Yes	Yes					
Recall Mode	None	None	None	None	None	C-Max	C-Max	C-Max	C-Max
v/c Ratio	0.01	0.88	0.04	0.38	0.40	0.19	0.21	0.35	0.61
Control Delay	10.0	30.4	1.1	13.2	5.9	44.6	19.1	46.5	52.1
Queue Delay	0.0	0.0	0.0	0.0	0.0	0.0	0.0	0.0	0.0
Total Delay	10.0	30.4	1.1	13.2	5.9	44.6	19.1	46.5	52.1
Queue Length 50th (m)	0.4	202.9	0.0	3.3	29.0	5.2	5.3	18.2	50.5
Queue Length 95th (m)	2.0	#322.6	2.4	10.7	41.5	14.0	19.0	34.4	77.6
Internal Link Dist (m)		465.5			505.1		463.9		452.2
Turn Bay Length (m)	30.0		30.0	60.0		30.0		30.0	
Base Capacity (vph)	420	1156	932	388	1286	135	364	243	364
Starvation Cap Reductn	0	0	0	0	0	0	0	0	0
Spillback Cap Reductn	0	0	0	0	0	0	0	0	0
Storage Cap Reductn	0	0	0	0	0	0	0	0	0
Reduced v/c Ratio	0.01	0.88	0.04	0.20	0.40	0.19	0.21	0.35	0.61

Intersection Summary

Cycle Length: 120
 Actuated Cycle Length: 120
 Offset: 43 (36%), Referenced to phase 2:NBTL and 6:SBTL, Start of Green
 Natural Cycle: 90
 Control Type: Actuated-Coordinated
 # 95th percentile volume exceeds capacity, queue may be longer.
 Queue shown is maximum after two cycles.

Splits and Phases: 2: Humber Station Road & Healey Road

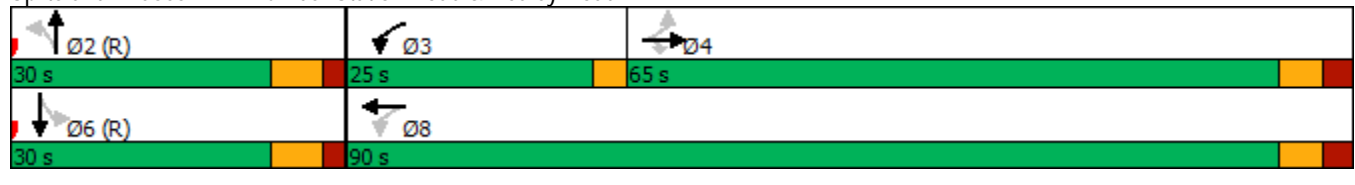

HCM Signalized Intersection Capacity Analysis

2: Humber Station Road & Healey Road

Future Background (2043) - Optimized
AM Peak Hour



Movement	EBL	EBT	EBR	WBL	WBT	WBR	NBL	NBT	NBR	SBL	SBT	SBR
Lane Configurations												
Traffic Volume (vph)	4	943	35	73	469	4	23	24	46	78	203	4
Future Volume (vph)	4	943	35	73	469	4	23	24	46	78	203	4
Ideal Flow (vphpl)	1900	1900	1900	1900	1900	1900	1900	1900	1900	1900	1900	1900
Lane Width	3.0	3.5	3.0	3.0	3.5	3.0	3.0	3.5	3.0	3.0	3.5	3.0
Total Lost time (s)	6.8	6.8	6.8	3.0	6.8		6.7	6.7		6.7	6.7	
Lane Util. Factor	1.00	1.00	1.00	1.00	1.00		1.00	1.00		1.00	1.00	
Fr _t	1.00	1.00	0.85	1.00	1.00		1.00	0.90		1.00	1.00	
Fl _t Protected	0.95	1.00	1.00	0.95	1.00		0.95	1.00		0.95	1.00	
Satd. Flow (prot)	1348	1860	1463	1668	1855		1546	1673		1685	1874	
Fl _t Permitted	0.48	1.00	1.00	0.09	1.00		0.43	1.00		0.71	1.00	
Satd. Flow (perm)	676	1860	1463	154	1855		698	1673		1256	1874	
Peak-hour factor, PHF	0.93	0.93	0.93	0.93	0.93	0.93	0.93	0.93	0.93	0.93	0.93	0.93
Adj. Flow (vph)	4	1014	38	78	504	4	25	26	49	84	218	4
RTOR Reduction (vph)	0	0	14	0	0	0	0	40	0	0	1	0
Lane Group Flow (vph)	4	1014	24	78	508	0	25	35	0	84	221	0
Heavy Vehicles (%)	25%	1%	3%	1%	1%	25%	9%	0%	2%	0%	0%	0%
Turn Type	Perm	NA	Perm	pm+pt	NA		Perm	NA		Perm	NA	
Protected Phases		4		3	8			2			6	
Permitted Phases	4		4	8			2			6		
Actuated Green, G (s)	74.6	74.6	74.6	83.8	83.8		22.7	22.7		22.7	22.7	
Effective Green, g (s)	74.6	74.6	74.6	83.8	83.8		22.7	22.7		22.7	22.7	
Actuated g/C Ratio	0.62	0.62	0.62	0.70	0.70		0.19	0.19		0.19	0.19	
Clearance Time (s)	6.8	6.8	6.8	3.0	6.8		6.7	6.7		6.7	6.7	
Vehicle Extension (s)	3.0	3.0	3.0	3.0	3.0		3.0	3.0		3.0	3.0	
Lane Grp Cap (vph)	420	1156	909	185	1295		132	316		237	354	
v/s Ratio Prot		c0.55		0.02	c0.27			0.02			c0.12	
v/s Ratio Perm	0.01		0.02	0.27			0.04			0.07		
v/c Ratio	0.01	0.88	0.03	0.42	0.39		0.19	0.11		0.35	0.62	
Uniform Delay, d ₁	8.6	18.9	8.7	20.4	7.5		40.9	40.3		42.3	44.7	
Progression Factor	1.00	1.00	1.00	1.64	0.63		1.00	1.00		1.00	1.00	
Incremental Delay, d ₂	0.0	7.7	0.0	1.5	0.2		3.2	0.7		4.1	8.1	
Delay (s)	8.6	26.6	8.7	35.0	4.9		44.1	41.0		46.4	52.8	
Level of Service	A	C	A	D	A		D	D		D	D	
Approach Delay (s)		25.9			8.9			41.8			51.1	
Approach LOS		C			A			D			D	

Intersection Summary

HCM 2000 Control Delay	25.6	HCM 2000 Level of Service	C
HCM 2000 Volume to Capacity ratio	0.79		
Actuated Cycle Length (s)	120.0	Sum of lost time (s)	16.5
Intersection Capacity Utilization	87.5%	ICU Level of Service	E
Analysis Period (min)	15		

c Critical Lane Group

Queues

3: Clarkway Drive/Humber Station Road & Mayfield Road

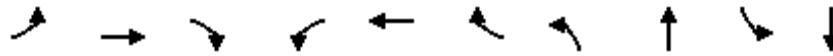

Lane Group	EBL	EBT	EBR	WBL	WBT	WBR	NBL	NBT	SBL	SBT
Lane Configurations	↖	↑↑↑	↗	↖	↑↑↑	↗	↖	↗	↖	↗
Traffic Volume (vph)	8	1878	28	51	751	21	11	70	23	301
Future Volume (vph)	8	1878	28	51	751	21	11	70	23	301
Lane Group Flow (vph)	8	1956	29	53	782	22	11	198	24	322
Turn Type	pm+pt	NA	Perm	pm+pt	NA	Perm	Perm	NA	Perm	NA
Protected Phases	5	2		1	6			4		8
Permitted Phases	2		2	6		6	4		8	
Detector Phase	5	2	2	1	6	6	4	4	8	8
Switch Phase										
Minimum Initial (s)	5.0	12.0	12.0	5.0	12.0	12.0	8.0	8.0	8.0	8.0
Minimum Split (s)	9.5	27.3	27.3	9.5	27.5	27.5	26.0	26.0	27.5	27.5
Total Split (s)	20.0	60.0	60.0	10.0	50.0	50.0	50.0	50.0	50.0	50.0
Total Split (%)	16.7%	50.0%	50.0%	8.3%	41.7%	41.7%	41.7%	41.7%	41.7%	41.7%
Yellow Time (s)	3.0	4.6	4.6	3.0	4.6	4.6	4.2	4.2	4.2	4.2
All-Red Time (s)	0.0	2.7	2.7	0.0	2.7	2.7	2.8	2.8	2.8	2.8
Lost Time Adjust (s)	0.0	0.0	0.0	0.0	0.0	0.0	0.0	0.0	0.0	0.0
Total Lost Time (s)	3.0	7.3	7.3	3.0	7.3	7.3	7.0	7.0	7.0	7.0
Lead/Lag	Lead	Lag	Lag	Lead	Lag	Lag				
Lead-Lag Optimize?	Yes	Yes	Yes	Yes	Yes	Yes				
Recall Mode	None	C-Max	C-Max	None	C-Max	C-Max	None	None	None	None
v/c Ratio	0.02	0.68	0.04	0.35	0.27	0.02	0.12	0.47	0.13	0.79
Control Delay	7.6	20.1	0.4	22.7	10.5	0.0	37.3	26.2	36.2	57.4
Queue Delay	0.0	0.0	0.0	0.0	0.0	0.0	0.0	0.0	0.0	0.0
Total Delay	7.6	20.1	0.4	22.7	10.5	0.0	37.3	26.2	36.2	57.4
Queue Length 50th (m)	0.6	119.3	0.0	3.7	26.8	0.0	2.2	24.9	4.8	75.6
Queue Length 95th (m)	2.6	167.9	0.7	16.7	47.9	0.0	7.2	44.4	11.6	100.3
Internal Link Dist (m)		1635.6			245.9			1187.5		1542.4
Turn Bay Length (m)	150.0		105.0	150.0		115.0			105.0	
Base Capacity (vph)	510	2863	739	156	2901	915	150	639	305	664
Starvation Cap Reductn	0	0	0	0	0	0	0	0	0	0
Spillback Cap Reductn	0	0	0	0	0	0	0	0	0	0
Storage Cap Reductn	0	0	0	0	0	0	0	0	0	0
Reduced v/c Ratio	0.02	0.68	0.04	0.34	0.27	0.02	0.07	0.31	0.08	0.48

Intersection Summary

Cycle Length: 120
 Actuated Cycle Length: 120
 Offset: 46 (38%), Referenced to phase 2:EBTL and 6:WBTL, Start of Green
 Natural Cycle: 80
 Control Type: Actuated-Coordinated

Splits and Phases: 3: Clarkway Drive/Humber Station Road & Mayfield Road



HCM Signalized Intersection Capacity Analysis

Future Background (2043) - Optimized

3: Clarkway Drive/Humber Station Road & Mayfield Road

AM Peak Hour



Movement	EBL	EBT	EBR	WBL	WBT	WBR	NBL	NBT	NBR	SBL	SBT	SBR
Lane Configurations	↘	↑↑↑	↗	↘	↑↑↑	↗	↘	↗		↘	↗	
Traffic Volume (vph)	8	1878	28	51	751	21	11	70	120	23	301	8
Future Volume (vph)	8	1878	28	51	751	21	11	70	120	23	301	8
Ideal Flow (vphpl)	1900	1900	1900	1900	1900	1900	1900	1900	1900	1900	1900	1900
Lane Width	3.0	3.5	3.0	3.0	3.5	3.0	3.0	3.5	3.0	3.0	3.5	3.0
Total Lost time (s)	3.0	7.3	7.3	3.0	7.3	7.3	7.0	7.0		7.0	7.0	
Lane Util. Factor	1.00	0.91	1.00	1.00	0.91	1.00	1.00	1.00		1.00	1.00	
Frt	1.00	1.00	0.85	1.00	1.00	0.85	1.00	0.91		1.00	1.00	
Flt Protected	0.95	1.00	1.00	0.95	1.00	1.00	0.95	1.00		0.95	1.00	
Satd. Flow (prot)	1491	4839	1206	1532	4499	1370	1428	1643		1546	1854	
Flt Permitted	0.34	1.00	1.00	0.06	1.00	1.00	0.28	1.00		0.52	1.00	
Satd. Flow (perm)	539	4839	1206	98	4499	1370	419	1643		852	1854	
Peak-hour factor, PHF	0.96	0.96	0.96	0.96	0.96	0.96	0.96	0.96	0.96	0.96	0.96	0.96
Adj. Flow (vph)	8	1956	29	53	782	22	11	73	125	24	314	8
RTOR Reduction (vph)	0	0	12	0	0	8	0	62	0	0	1	0
Lane Group Flow (vph)	8	1956	17	53	782	14	11	136	0	24	321	0
Heavy Vehicles (%)	13%	6%	25%	10%	14%	10%	18%	1%	5%	9%	1%	0%
Turn Type	pm+pt	NA	Perm	pm+pt	NA	Perm	Perm	NA		Perm	NA	
Protected Phases	5	2		1	6			4			8	
Permitted Phases	2		2	6		6	4			8		
Actuated Green, G (s)	71.8	70.5	70.5	79.3	75.0	75.0	26.4	26.4		26.4	26.4	
Effective Green, g (s)	71.8	70.5	70.5	79.3	75.0	75.0	26.4	26.4		26.4	26.4	
Actuated g/C Ratio	0.60	0.59	0.59	0.66	0.62	0.62	0.22	0.22		0.22	0.22	
Clearance Time (s)	3.0	7.3	7.3	3.0	7.3	7.3	7.0	7.0		7.0	7.0	
Vehicle Extension (s)	3.0	3.0	3.0	3.0	3.0	3.0	3.0	3.0		3.0	3.0	
Lane Grp Cap (vph)	332	2842	708	134	2811	856	92	361		187	407	
v/s Ratio Prot	0.00	c0.40		c0.02	0.17			0.08			c0.17	
v/s Ratio Perm	0.01		0.01	0.24		0.01	0.03			0.03		
v/c Ratio	0.02	0.69	0.02	0.40	0.28	0.02	0.12	0.38		0.13	0.79	
Uniform Delay, d1	9.7	17.1	10.4	12.2	10.2	8.5	37.5	39.8		37.6	44.2	
Progression Factor	1.00	1.00	1.00	1.95	0.99	1.00	1.00	1.00		1.00	1.00	
Incremental Delay, d2	0.0	1.4	0.1	1.9	0.2	0.0	0.6	0.7		0.3	9.7	
Delay (s)	9.8	18.5	10.4	25.6	10.3	8.6	38.1	40.5		37.9	53.9	
Level of Service	A	B	B	C	B	A	D	D		D	D	
Approach Delay (s)		18.4			11.2			40.3			52.8	
Approach LOS		B			B			D			D	

Intersection Summary

HCM 2000 Control Delay	21.4	HCM 2000 Level of Service	C
HCM 2000 Volume to Capacity ratio	0.70		
Actuated Cycle Length (s)	120.0	Sum of lost time (s)	17.3
Intersection Capacity Utilization	73.4%	ICU Level of Service	D
Analysis Period (min)	15		

c Critical Lane Group

Queues

4: Coleraine Drive & Mayfield Road

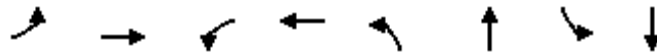

Lane Group	EBL	EBT	WBL	WBT	NBL	NBT	SBL	SBT
Lane Configurations	↖	↕	↖	↕	↖	↕	↖	↕
Traffic Volume (vph)	439	709	44	812	10	180	67	339
Future Volume (vph)	439	709	44	812	10	180	67	339
Lane Group Flow (vph)	499	834	50	965	11	215	76	626
Turn Type	pm+pt	NA	Perm	NA	Perm	NA	Perm	NA
Protected Phases	5	2		6		4		8
Permitted Phases	2		6		4		8	
Detector Phase	5	2	6	6	4	4	8	8
Switch Phase								
Minimum Initial (s)	5.0	12.0	12.0	12.0	12.0	12.0	12.0	12.0
Minimum Split (s)	8.0	37.0	37.0	37.0	37.0	37.0	37.0	37.0
Total Split (s)	44.0	93.0	49.0	49.0	37.0	37.0	37.0	37.0
Total Split (%)	33.8%	71.5%	37.7%	37.7%	28.5%	28.5%	28.5%	28.5%
Yellow Time (s)	3.0	4.6	4.6	4.6	4.2	4.2	4.2	4.2
All-Red Time (s)	0.0	2.4	2.4	2.4	2.8	2.8	2.8	2.8
Lost Time Adjust (s)	0.0	0.0	0.0	0.0	0.0	0.0	0.0	0.0
Total Lost Time (s)	3.0	7.0	7.0	7.0	7.0	7.0	7.0	7.0
Lead/Lag	Lead		Lag	Lag				
Lead-Lag Optimize?	Yes		Yes	Yes				
Recall Mode	None	C-Max	C-Max	C-Max	None	None	None	None
v/c Ratio	0.89	0.26	0.23	0.76	0.23	0.30	0.40	0.86
Control Delay	45.9	8.1	35.3	41.8	54.5	43.7	50.5	54.7
Queue Delay	0.0	0.0	0.0	0.0	0.0	0.0	0.0	0.0
Total Delay	45.9	8.1	35.3	41.8	54.5	43.7	50.5	54.7
Queue Length 50th (m)	94.2	28.9	9.7	126.4	2.5	25.5	17.8	73.3
Queue Length 95th (m)	#149.6	36.8	21.5	#154.2	8.6	35.7	32.4	91.3
Internal Link Dist (m)		290.4		195.1		791.2		576.8
Turn Bay Length (m)	100.0		85.0		105.0		145.0	
Base Capacity (vph)	601	3177	217	1262	54	816	217	809
Starvation Cap Reductn	0	0	0	0	0	0	0	0
Spillback Cap Reductn	0	0	0	0	0	0	0	0
Storage Cap Reductn	0	0	0	0	0	0	0	0
Reduced v/c Ratio	0.83	0.26	0.23	0.76	0.20	0.26	0.35	0.77

Intersection Summary

Cycle Length: 130
 Actuated Cycle Length: 130
 Offset: 92 (71%), Referenced to phase 2:EBTL and 6:WBTL, Start of Green
 Natural Cycle: 95
 Control Type: Actuated-Coordinated
 # 95th percentile volume exceeds capacity, queue may be longer.
 Queue shown is maximum after two cycles.

























Splits and Phases: 4: Coleraine Drive & Mayfield Road



HCM Signalized Intersection Capacity Analysis

4: Coleraine Drive & Mayfield Road

Future Background (2043) - Optimized
AM Peak Hour

												
Movement	EBL	EBT	EBR	WBL	WBT	WBR	NBL	NBT	NBR	SBL	SBT	SBR
Lane Configurations												
Traffic Volume (vph)	439	709	25	44	812	37	10	180	9	67	339	212
Future Volume (vph)	439	709	25	44	812	37	10	180	9	67	339	212
Ideal Flow (vphpl)	1900	1900	1900	1900	1900	1900	1900	1900	1900	1900	1900	1900
Lane Width	3.0	3.5	3.0	3.0	3.5	3.0	3.0	3.5	3.0	3.0	3.5	3.0
Total Lost time (s)	3.0	7.0		7.0	7.0		7.0	7.0		7.0	7.0	
Lane Util. Factor	1.00	0.91		1.00	0.95		1.00	0.95		1.00	0.95	
Flt	1.00	0.99		1.00	0.99		1.00	0.99		1.00	0.94	
Flt Protected	0.95	1.00		0.95	1.00		0.95	1.00		0.95	1.00	
Satd. Flow (prot)	1604	4608		1685	3347		1404	3527		1452	3180	
Flt Permitted	0.14	1.00		0.33	1.00		0.16	1.00		0.62	1.00	
Satd. Flow (perm)	233	4608		578	3347		236	3527		944	3180	
Peak-hour factor, PHF	0.88	0.88	0.88	0.88	0.88	0.88	0.88	0.88	0.88	0.88	0.88	0.88
Adj. Flow (vph)	499	806	28	50	923	42	11	205	10	76	385	241
RTOR Reduction (vph)	0	2	0	0	2	0	0	2	0	0	79	0
Lane Group Flow (vph)	499	832	0	50	963	0	11	213	0	76	547	0
Heavy Vehicles (%)	5%	11%	4%	0%	5%	27%	20%	0%	11%	16%	0%	15%
Turn Type	pm+pt	NA		Perm	NA		Perm	NA		Perm	NA	
Protected Phases	5	2			6			4			8	
Permitted Phases	2			6			4			8		
Actuated Green, G (s)	89.6	89.6		49.0	49.0		26.4	26.4		26.4	26.4	
Effective Green, g (s)	89.6	89.6		49.0	49.0		26.4	26.4		26.4	26.4	
Actuated g/C Ratio	0.69	0.69		0.38	0.38		0.20	0.20		0.20	0.20	
Clearance Time (s)	3.0	7.0		7.0	7.0		7.0	7.0		7.0	7.0	
Vehicle Extension (s)	3.0	3.0		3.0	3.0		3.0	3.0		3.0	3.0	
Lane Grp Cap (vph)	557	3175		217	1261		47	716		191	645	
v/s Ratio Prot	c0.26	0.18			0.29			0.06			c0.17	
v/s Ratio Perm	c0.36			0.09			0.05			0.08		
v/c Ratio	0.90	0.26		0.23	0.76		0.23	0.30		0.40	0.85	
Uniform Delay, d1	31.1	7.7		27.6	35.4		43.3	43.9		44.9	49.9	
Progression Factor	1.00	1.00		1.00	1.00		1.00	1.00		1.00	1.00	
Incremental Delay, d2	16.9	0.2		2.5	4.4		2.6	0.2		1.4	10.1	
Delay (s)	48.0	7.9		30.1	39.8		45.9	44.2		46.3	60.0	
Level of Service	D	A		C	D		D	D		D	E	
Approach Delay (s)		22.9			39.4			44.2			58.5	
Approach LOS		C			D			D			E	
Intersection Summary												
HCM 2000 Control Delay			37.1									D
HCM 2000 Volume to Capacity ratio			0.90									
Actuated Cycle Length (s)			130.0								17.0	
Intersection Capacity Utilization			94.9%									F
Analysis Period (min)			15									

c Critical Lane Group

Queues

Future Background (2043) - Optimized

5: Coleraine Drive & Private Access/George Bolton Parkway

AM Peak Hour



Lane Group	EBL	EBT	WBL	WBT	NBL	NBT	SBL	SBT	SBR
Lane Configurations	↖	↗	↖	↗	↖	↗	↖	↗	↗
Traffic Volume (vph)	4	12	63	23	30	446	84	476	11
Future Volume (vph)	4	12	63	23	30	446	84	476	11
Lane Group Flow (vph)	5	29	73	191	35	631	98	553	13
Turn Type	Perm	NA	Perm	NA	Perm	NA	Perm	NA	Perm
Protected Phases		8		4		6		2	
Permitted Phases	8		4		6		2		2
Detector Phase	8	8	4	4	6	6	2	2	2
Switch Phase									
Minimum Initial (s)	8.0	8.0	12.0	12.0	12.0	12.0	12.0	12.0	12.0
Minimum Split (s)	32.5	32.5	32.5	32.5	34.2	34.2	33.7	33.7	33.7
Total Split (s)	45.0	45.0	45.0	45.0	55.0	55.0	55.0	55.0	55.0
Total Split (%)	45.0%	45.0%	45.0%	45.0%	55.0%	55.0%	55.0%	55.0%	55.0%
Yellow Time (s)	4.0	4.0	4.0	4.0	4.2	4.2	4.2	4.2	4.2
All-Red Time (s)	3.5	3.5	3.5	3.5	2.5	2.5	2.5	2.5	2.5
Lost Time Adjust (s)	0.0	0.0	0.0	0.0	0.0	0.0	0.0	0.0	0.0
Total Lost Time (s)	7.5	7.5	7.5	7.5	6.7	6.7	6.7	6.7	6.7
Lead/Lag									
Lead-Lag Optimize?									
Recall Mode	None	None	None	None	C-Max	C-Max	C-Max	C-Max	C-Max
v/c Ratio	0.04	0.15	0.52	0.56	0.08	0.29	0.20	0.25	0.01
Control Delay	35.2	24.0	52.1	15.3	5.6	5.5	6.6	5.6	0.0
Queue Delay	0.0	0.0	0.0	0.0	0.0	0.0	0.0	0.0	0.0
Total Delay	35.2	24.0	52.1	15.3	5.6	5.5	6.6	5.6	0.0
Queue Length 50th (m)	0.9	2.6	14.2	5.0	1.7	18.1	5.3	16.4	0.0
Queue Length 95th (m)	3.9	9.7	25.9	21.4	5.7	30.9	13.9	28.2	0.0
Internal Link Dist (m)		152.4		468.8		784.9		1711.9	
Turn Bay Length (m)	70.0		105.0		75.0		100.0		100.0
Base Capacity (vph)	345	486	369	633	458	2199	491	2216	1001
Starvation Cap Reductn	0	0	0	0	0	0	0	0	0
Spillback Cap Reductn	0	0	0	0	0	0	0	0	0
Storage Cap Reductn	0	0	0	0	0	0	0	0	0
Reduced v/c Ratio	0.01	0.06	0.20	0.30	0.08	0.29	0.20	0.25	0.01

Intersection Summary

Cycle Length: 100

Actuated Cycle Length: 100

Offset: 0 (0%), Referenced to phase 2:SBTL and 6:NBTL, Start of Green

Natural Cycle: 70

Control Type: Actuated-Coordinated

Splits and Phases: 5: Coleraine Drive & Private Access/George Bolton Parkway

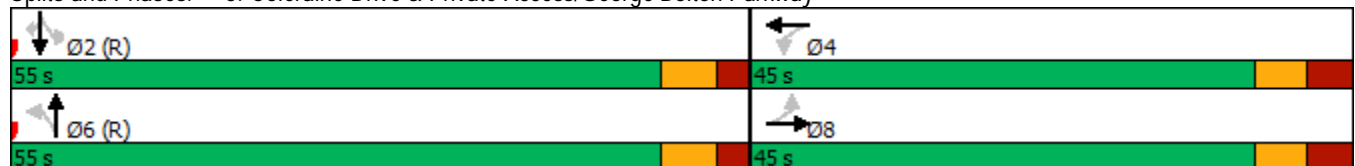

HCM Signalized Intersection Capacity Analysis

Future Background (2043) - Optimized

5: Coleraine Drive & Private Access/George Bolton Parkway

AM Peak Hour



Movement	EBL	EBT	EBR	WBL	WBT	WBR	NBL	NBT	NBR	SBL	SBT	SBR
Lane Configurations												
Traffic Volume (vph)	4	12	13	63	23	141	30	446	96	84	476	11
Future Volume (vph)	4	12	13	63	23	141	30	446	96	84	476	11
Ideal Flow (vphpl)	1900	1900	1900	1900	1900	1900	1900	1900	1900	1900	1900	1900
Lane Width	3.0	3.5	3.0	3.0	3.5	3.0	3.0	3.5	3.0	3.0	3.5	3.0
Total Lost time (s)	7.5	7.5		7.5	7.5		6.7	6.7		6.7	6.7	6.7
Lane Util. Factor	1.00	1.00		1.00	1.00		1.00	0.95		1.00	0.95	1.00
Fr _t	1.00	0.92		1.00	0.87		1.00	0.97		1.00	1.00	0.85
Fl _t Protected	0.95	1.00		0.95	1.00		0.95	1.00		0.95	1.00	1.00
Satd. Flow (prot)	1685	1271		1267	1417		1370	3068		1589	3104	1383
Fl _t Permitted	0.52	1.00		0.74	1.00		0.45	1.00		0.41	1.00	1.00
Satd. Flow (perm)	921	1271		984	1417		642	3068		690	3104	1383
Peak-hour factor, PHF	0.86	0.86	0.86	0.86	0.86	0.86	0.86	0.86	0.86	0.86	0.86	0.86
Adj. Flow (vph)	5	14	15	73	27	164	35	519	112	98	553	13
RTOR Reduction (vph)	0	13	0	0	140	0	0	10	0	0	0	4
Lane Group Flow (vph)	5	16	0	73	51	0	35	621	0	98	553	9
Heavy Vehicles (%)	0%	42%	31%	33%	43%	11%	23%	12%	19%	6%	15%	9%
Turn Type	Perm	NA		Perm	NA		Perm	NA		Perm	NA	Perm
Protected Phases		8			4			6			2	
Permitted Phases	8			4			6			2		2
Actuated Green, G (s)	14.4	14.4		14.4	14.4		71.4	71.4		71.4	71.4	71.4
Effective Green, g (s)	14.4	14.4		14.4	14.4		71.4	71.4		71.4	71.4	71.4
Actuated g/C Ratio	0.14	0.14		0.14	0.14		0.71	0.71		0.71	0.71	0.71
Clearance Time (s)	7.5	7.5		7.5	7.5		6.7	6.7		6.7	6.7	6.7
Vehicle Extension (s)	3.0	3.0		3.0	3.0		3.0	3.0		3.0	3.0	3.0
Lane Grp Cap (vph)	132	183		141	204		458	2190		492	2216	987
v/s Ratio Prot		0.01			0.04			c0.20			0.18	
v/s Ratio Perm	0.01			c0.07			0.05			0.14		0.01
v/c Ratio	0.04	0.09		0.52	0.25		0.08	0.28		0.20	0.25	0.01
Uniform Delay, d ₁	36.8	37.1		39.6	38.0		4.3	5.1		4.8	5.0	4.1
Progression Factor	1.00	1.00		1.00	1.00		1.00	1.00		1.00	1.00	1.00
Incremental Delay, d ₂	0.1	0.2		3.2	0.6		0.3	0.3		0.9	0.3	0.0
Delay (s)	37.0	37.3		42.8	38.6		4.7	5.5		5.7	5.2	4.1
Level of Service	D	D		D	D		A	A		A	A	A
Approach Delay (s)		37.3			39.8			5.4			5.3	
Approach LOS		D			D			A			A	

Intersection Summary

HCM 2000 Control Delay	11.6	HCM 2000 Level of Service	B
HCM 2000 Volume to Capacity ratio	0.32		
Actuated Cycle Length (s)	100.0	Sum of lost time (s)	14.2
Intersection Capacity Utilization	53.0%	ICU Level of Service	A
Analysis Period (min)	15		

c Critical Lane Group

Queues

Future Background (2043) - Optimized

6: Highway 50 & George Bolton Parkway/Private Access

AM Peak Hour



Lane Group	EBL	EBT	WBT	NBL	NBT	SBL	SBT	SBR
Lane Configurations								
Traffic Volume (vph)	76	0	0	178	1030	3	1144	138
Future Volume (vph)	76	0	0	178	1030	3	1144	138
Lane Group Flow (vph)	79	108	1	185	1073	3	1192	144
Turn Type	Perm	NA	NA	pm+pt	NA	Perm	NA	Perm
Protected Phases		8	4	1	6		2	
Permitted Phases	8			6		2		2
Detector Phase	8	8	4	1	6	2	2	2
Switch Phase								
Minimum Initial (s)	8.0	8.0	8.0	5.0	12.0	12.0	12.0	12.0
Minimum Split (s)	32.6	32.6	32.6	8.0	27.3	27.3	27.3	27.3
Total Split (s)	35.0	35.0	35.0	10.0	85.0	75.0	75.0	75.0
Total Split (%)	29.2%	29.2%	29.2%	8.3%	70.8%	62.5%	62.5%	62.5%
Yellow Time (s)	4.0	4.0	4.0	3.0	4.0	4.0	4.0	4.0
All-Red Time (s)	2.6	2.6	2.6	0.0	2.3	2.3	2.3	2.3
Lost Time Adjust (s)	0.0	0.0	0.0	0.0	0.0	0.0	0.0	0.0
Total Lost Time (s)	6.6	6.6	6.6	3.0	6.3	6.3	6.3	6.3
Lead/Lag				Lead		Lag	Lag	Lag
Lead-Lag Optimize?				Yes		Yes	Yes	Yes
Recall Mode	None	None	None	None	C-Max	C-Max	C-Max	C-Max
v/c Ratio	0.59	0.40	0.00	0.57	0.40	0.01	0.54	0.14
Control Delay	67.3	5.8	0.0	10.5	5.0	9.7	12.9	2.3
Queue Delay	0.0	0.0	0.0	0.0	0.0	0.0	0.0	0.0
Total Delay	67.3	5.8	0.0	10.5	5.0	9.7	12.9	2.3
Queue Length 50th (m)	18.9	0.0	0.0	8.0	36.6	0.2	73.5	0.5
Queue Length 95th (m)	34.2	4.3	0.0	18.6	58.9	1.8	121.1	9.6
Internal Link Dist (m)		846.5	43.0		1045.6		1307.8	
Turn Bay Length (m)	85.0			40.0		135.0		60.0
Base Capacity (vph)	286	399	480	325	2681	313	2190	1006
Starvation Cap Reductn	0	0	0	0	0	0	0	0
Spillback Cap Reductn	0	0	0	0	0	0	0	0
Storage Cap Reductn	0	0	0	0	0	0	0	0
Reduced v/c Ratio	0.28	0.27	0.00	0.57	0.40	0.01	0.54	0.14

Intersection Summary





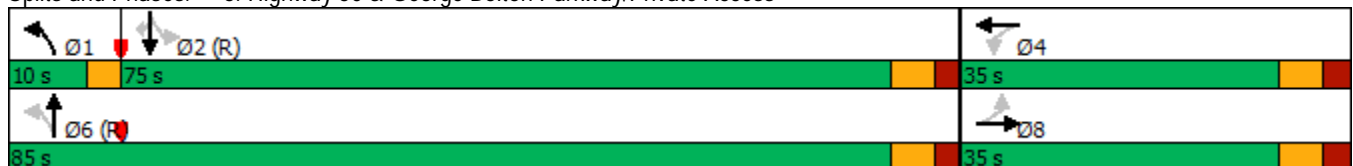















Cycle Length: 120
 Actuated Cycle Length: 120
 Offset: 0 (0%), Referenced to phase 2:SBTL and 6:NBTL, Start of Green
 Natural Cycle: 80
 Control Type: Actuated-Coordinated

Splits and Phases: 6: Highway 50 & George Bolton Parkway/Private Access



HCM Signalized Intersection Capacity Analysis
6: Highway 50 & George Bolton Parkway/Private Access

Future Background (2043) - Optimized
AM Peak Hour

													
Movement	EBL	EBT	EBR	WBL	WBT	WBR	NBL	NBT	NBR	SBL	SBT	SBR	
Lane Configurations													
Traffic Volume (vph)	76	0	104	0	0	1	178	1030	0	3	1144	138	
Future Volume (vph)	76	0	104	0	0	1	178	1030	0	3	1144	138	
Ideal Flow (vphpl)	1900	1900	1900	1900	1900	1900	1900	1900	1900	1900	1900	1900	
Lane Width	3.0	3.5	3.0	3.0	3.5	3.0	3.0	3.5	3.0	3.0	3.5	3.0	
Total Lost time (s)	6.6	6.6			6.6		3.0	6.3		6.3	6.3	6.3	
Lane Util. Factor	1.00	1.00			1.00		1.00	0.95		1.00	0.95	1.00	
Frt	1.00	0.85			0.86		1.00	1.00		1.00	1.00	0.85	
Flt Protected	0.95	1.00			1.00		0.95	1.00		0.95	1.00	1.00	
Satd. Flow (prot)	1518	1166			1625		1404	3433		1685	3305	1449	
Flt Permitted	0.76	1.00			1.00		0.18	1.00		0.27	1.00	1.00	
Satd. Flow (perm)	1210	1166			1625		272	3433		473	3305	1449	
Peak-hour factor, PHF	0.96	0.96	0.96	0.96	0.96	0.96	0.96	0.96	0.96	0.96	0.96	0.96	
Adj. Flow (vph)	79	0	108	0	0	1	185	1073	0	3	1192	144	
RTOR Reduction (vph)	0	96	0	0	1	0	0	0	0	0	0	46	
Lane Group Flow (vph)	79	12	0	0	0	0	185	1073	0	3	1192	98	
Heavy Vehicles (%)	11%	0%	37%	0%	0%	0%	20%	4%	0%	0%	8%	4%	
Turn Type	Perm	NA			NA		pm+pt	NA		Perm	NA	Perm	
Protected Phases		8			4		1	6			2		
Permitted Phases	8			4			6			2		2	
Actuated Green, G (s)	13.4	13.4			13.4		93.7	93.7		79.5	79.5	79.5	
Effective Green, g (s)	13.4	13.4			13.4		93.7	93.7		79.5	79.5	79.5	
Actuated g/C Ratio	0.11	0.11			0.11		0.78	0.78		0.66	0.66	0.66	
Clearance Time (s)	6.6	6.6			6.6		3.0	6.3		6.3	6.3	6.3	
Vehicle Extension (s)	3.0	3.0			3.0		3.0	3.0		3.0	3.0	3.0	
Lane Grp Cap (vph)	135	130			181		318	2680		313	2189	959	
v/s Ratio Prot		0.01			0.00		c0.05	0.31			0.36		
v/s Ratio Perm	c0.07						c0.40			0.01		0.07	
v/c Ratio	0.59	0.09			0.00		0.58	0.40		0.01	0.54	0.10	
Uniform Delay, d1	50.7	47.8			47.4		6.3	4.2		6.9	10.7	7.3	
Progression Factor	1.00	1.00			1.00		1.00	1.00		1.00	1.00	1.00	
Incremental Delay, d2	6.3	0.3			0.0		2.7	0.4		0.1	1.0	0.2	
Delay (s)	57.0	48.2			47.4		9.0	4.6		6.9	11.7	7.5	
Level of Service	E	D			D		A	A		A	B	A	
Approach Delay (s)		51.9			47.4			5.3			11.2		
Approach LOS		D			D			A			B		

Intersection Summary

HCM 2000 Control Delay	11.3	HCM 2000 Level of Service	B
HCM 2000 Volume to Capacity ratio	0.60		
Actuated Cycle Length (s)	120.0	Sum of lost time (s)	15.9
Intersection Capacity Utilization	66.4%	ICU Level of Service	C
Analysis Period (min)	15		

c Critical Lane Group

Queues
7: Arterial A2 & Mayfield Road

Future Background (2043) - Optimized
AM Peak Hour



Lane Group	EBT	EBR	WBL	WBT	NBL	NBR
Lane Configurations	↑↑↑	↑	↓	↑↑↑	↓	↑
Traffic Volume (vph)	1213	808	212	813	10	121
Future Volume (vph)	1213	808	212	813	10	121
Lane Group Flow (vph)	1264	842	221	847	73	63
Turn Type	NA	Perm	Perm	NA	Prot	Perm
Protected Phases	2			6	4	
Permitted Phases		2	6			4
Detector Phase	2	2	6	6	4	4
Switch Phase						
Minimum Initial (s)	12.0	12.0	12.0	12.0	8.0	8.0
Minimum Split (s)	30.3	30.3	30.3	30.3	30.0	30.0
Total Split (s)	80.0	80.0	80.0	80.0	40.0	40.0
Total Split (%)	66.7%	66.7%	66.7%	66.7%	33.3%	33.3%
Yellow Time (s)	4.6	4.6	4.6	4.6	4.2	4.2
All-Red Time (s)	2.7	2.7	2.7	2.7	2.8	2.8
Lost Time Adjust (s)	0.0	0.0	0.0	0.0	0.0	0.0
Total Lost Time (s)	7.3	7.3	7.3	7.3	7.0	7.0
Lead/Lag						
Lead-Lag Optimize?						
Recall Mode	C-Max	C-Max	C-Max	C-Max	None	None
v/c Ratio	0.32	0.60	0.72	0.22	0.28	0.41
Control Delay	0.4	6.5	21.9	2.5	18.9	21.1
Queue Delay	0.0	0.0	0.0	0.0	0.0	0.0
Total Delay	0.4	6.5	21.9	2.5	18.9	21.1
Queue Length 50th (m)	1.4	43.2	20.4	13.8	1.2	0.0
Queue Length 95th (m)	2.2	65.8	#90.5	19.7	8.7	15.6
Internal Link Dist (m)	117.8			619.0	876.4	
Turn Bay Length (m)		60.0	100.0			
Base Capacity (vph)	3949	1405	309	3844	850	415
Starvation Cap Reductn	0	0	0	0	0	0
Spillback Cap Reductn	0	0	0	0	0	0
Storage Cap Reductn	0	0	0	0	0	0
Reduced v/c Ratio	0.32	0.60	0.72	0.22	0.09	0.15

Intersection Summary





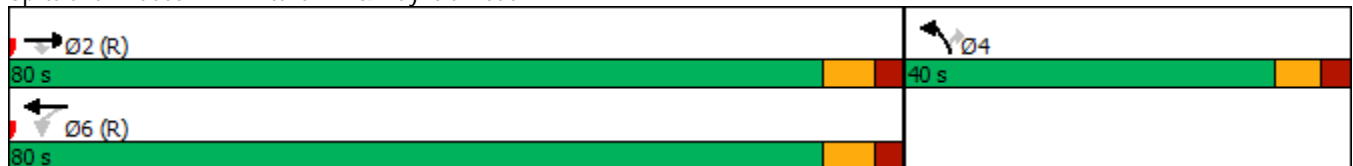

Cycle Length: 120
 Actuated Cycle Length: 120
 Offset: 61 (51%), Referenced to phase 2:EBT and 6:WBTL, Start of Green
 Natural Cycle: 110
 Control Type: Actuated-Coordinated
 # 95th percentile volume exceeds capacity, queue may be longer.
 Queue shown is maximum after two cycles.

Splits and Phases: 7: Arterial A2 & Mayfield Road



HCM Signalized Intersection Capacity Analysis
7: Arterial A2 & Mayfield Road

Future Background (2043) - Optimized
AM Peak Hour

						
Movement	EBT	EBR	WBL	WBT	NBL	NBR
Lane Configurations	↑↑↑	↑	↓	↑↑↑	↓↓↓	↑
Traffic Volume (vph)	1213	808	212	813	10	121
Future Volume (vph)	1213	808	212	813	10	121
Ideal Flow (vphpl)	1900	1900	1900	1900	1900	1900
Lane Width	3.5	3.0	3.0	3.5	3.0	3.0
Total Lost time (s)	7.3	7.3	7.3	7.3	7.0	7.0
Lane Util. Factor	0.91	1.00	1.00	0.91	0.97	0.91
Frt	1.00	0.85	1.00	1.00	0.87	0.85
Flt Protected	1.00	1.00	0.95	1.00	0.99	1.00
Satd. Flow (prot)	4663	1507	1668	4539	2924	1345
Flt Permitted	1.00	1.00	0.21	1.00	0.99	1.00
Satd. Flow (perm)	4663	1507	365	4539	2924	1345
Peak-hour factor, PHF	0.96	0.96	0.96	0.96	0.96	0.96
Adj. Flow (vph)	1264	842	221	847	10	126
RTOR Reduction (vph)	0	149	0	0	59	59
Lane Group Flow (vph)	1264	693	221	847	14	4
Heavy Vehicles (%)	10%	0%	1%	13%	0%	2%
Turn Type	NA	Perm	Perm	NA	Prot	Perm
Protected Phases	2			6	4	
Permitted Phases		2	6			4
Actuated Green, G (s)	98.8	98.8	98.8	98.8	6.9	6.9
Effective Green, g (s)	98.8	98.8	98.8	98.8	6.9	6.9
Actuated g/C Ratio	0.82	0.82	0.82	0.82	0.06	0.06
Clearance Time (s)	7.3	7.3	7.3	7.3	7.0	7.0
Vehicle Extension (s)	3.0	3.0	3.0	3.0	3.0	3.0
Lane Grp Cap (vph)	3839	1240	300	3737	168	77
v/s Ratio Prot	0.27			0.19	c0.00	
v/s Ratio Perm		0.46	c0.61			0.00
v/c Ratio	0.33	0.56	0.74	0.23	0.08	0.05
Uniform Delay, d1	2.6	3.5	4.8	2.3	53.5	53.4
Progression Factor	0.08	22.29	1.00	1.00	1.00	1.00
Incremental Delay, d2	0.2	1.4	14.9	0.1	0.2	0.3
Delay (s)	0.4	78.8	19.7	2.4	53.8	53.7
Level of Service	A	E	B	A	D	D
Approach Delay (s)	31.7			6.0	53.7	
Approach LOS	C			A	D	

Intersection Summary

HCM 2000 Control Delay	24.3	HCM 2000 Level of Service	C
HCM 2000 Volume to Capacity ratio	0.69		
Actuated Cycle Length (s)	120.0	Sum of lost time (s)	14.3
Intersection Capacity Utilization	73.9%	ICU Level of Service	D
Analysis Period (min)	15		

c Critical Lane Group

Queues

9: Humber Station Road & Subject Lands Site Access #1

	↑	↓	
Lane Group	NBT	SBT	Ø8
Lane Configurations	↑	↑	
Traffic Volume (vph)	99	332	
Future Volume (vph)	99	332	
Lane Group Flow (vph)	99	332	
Turn Type	NA	NA	
Protected Phases	2	6	8
Permitted Phases			
Detector Phase	2	6	
Switch Phase			
Minimum Initial (s)	12.0	12.0	12.0
Minimum Split (s)	24.7	24.7	25.5
Total Split (s)	75.0	75.0	45.0
Total Split (%)	62.5%	62.5%	38%
Yellow Time (s)	4.2	4.2	4.0
All-Red Time (s)	2.5	2.5	3.5
Lost Time Adjust (s)	0.0	0.0	
Total Lost Time (s)	6.7	6.7	
Lead/Lag			
Lead-Lag Optimize?			
Recall Mode	C-Max	C-Max	None
v/c Ratio	0.05	0.18	
Control Delay	0.1	0.2	
Queue Delay	0.0	0.0	
Total Delay	0.1	0.2	
Queue Length 50th (m)	0.0	0.0	
Queue Length 95th (m)	0.0	0.0	
Internal Link Dist (m)	1542.4	469.4	
Turn Bay Length (m)			
Base Capacity (vph)	1807	1860	
Starvation Cap Reductn	0	0	
Spillback Cap Reductn	0	0	
Storage Cap Reductn	0	0	
Reduced v/c Ratio	0.05	0.18	

Intersection Summary

Cycle Length: 120
 Actuated Cycle Length: 120
 Offset: 116 (97%), Referenced to phase 2:NBT and 6:SBTL, Start of Green
 Natural Cycle: 55
 Control Type: Actuated-Coordinated

Splits and Phases: 9: Humber Station Road & Subject Lands Site Access #1

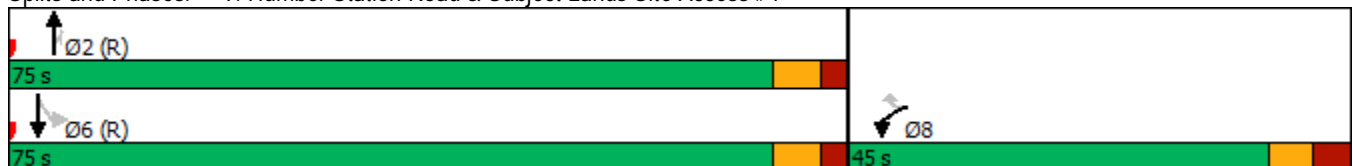

HCM Signalized Intersection Capacity Analysis
 9: Humber Station Road & Subject Lands Site Access #1

Future Background (2043) - Optimized
 AM Peak Hour



Movement	WBL	WBR	NBT	NBR	SBL	SBT
Lane Configurations	↶	↷	↕	↷	↶	↕
Traffic Volume (vph)	0	0	99	0	0	332
Future Volume (vph)	0	0	99	0	0	332
Ideal Flow (vphpl)	1900	1900	1900	1900	1900	1900
Lane Width	3.0	3.0	3.5	3.0	3.0	3.5
Total Lost time (s)			6.7			6.7
Lane Util. Factor			1.00			1.00
Frt			1.00			1.00
Flt Protected			1.00			1.00
Satd. Flow (prot)			1807			1860
Flt Permitted			1.00			1.00
Satd. Flow (perm)			1807			1860
Peak-hour factor, PHF	1.00	1.00	1.00	1.00	1.00	1.00
Adj. Flow (vph)	0	0	99	0	0	332
RTOR Reduction (vph)	0	0	0	0	0	0
Lane Group Flow (vph)	0	0	99	0	0	332
Heavy Vehicles (%)	0%	0%	4%	0%	0%	1%
Turn Type	Prot	Perm	NA	Perm	Perm	NA
Protected Phases	8		2			6
Permitted Phases		8		2	6	
Actuated Green, G (s)			120.0			120.0
Effective Green, g (s)			120.0			120.0
Actuated g/C Ratio			1.00			1.00
Clearance Time (s)			6.7			6.7
Vehicle Extension (s)			3.0			3.0
Lane Grp Cap (vph)			1807			1860
v/s Ratio Prot			0.05			c0.18
v/s Ratio Perm						
v/c Ratio			0.05			0.18
Uniform Delay, d1			0.0			0.0
Progression Factor			1.00			1.00
Incremental Delay, d2			0.1			0.2
Delay (s)			0.1			0.2
Level of Service			A			A
Approach Delay (s)	0.0		0.1			0.2
Approach LOS	A		A			A

Intersection Summary

HCM 2000 Control Delay	0.2	HCM 2000 Level of Service	A
HCM 2000 Volume to Capacity ratio	0.20		
Actuated Cycle Length (s)	120.0	Sum of lost time (s)	14.2
Intersection Capacity Utilization	23.1%	ICU Level of Service	A
Analysis Period (min)	15		

c Critical Lane Group

Queues
24: Mayfield Road & Triangle Lands

Future Background (2043) - Optimized
AM Peak Hour

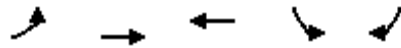

Lane Group	EBL	EBT	WBT	SBL	SBR
Lane Configurations	↗	↑↑↑	↑↑↑	↖	↗
Traffic Volume (vph)	160	1174	943	33	72
Future Volume (vph)	160	1174	943	33	72
Lane Group Flow (vph)	160	1174	1051	33	72
Turn Type	Perm	NA	NA	Prot	Perm
Protected Phases		2	6	4	
Permitted Phases	2				4
Detector Phase	2	2	6	4	4
Switch Phase					
Minimum Initial (s)	12.0	12.0	5.0	12.0	12.0
Minimum Split (s)	25.0	25.0	25.0	25.0	25.0
Total Split (s)	162.0	162.0	162.0	28.0	28.0
Total Split (%)	85.3%	85.3%	85.3%	14.7%	14.7%
Yellow Time (s)	4.6	4.6	4.2	4.6	4.6
All-Red Time (s)	2.4	2.4	2.8	2.4	2.4
Lost Time Adjust (s)	0.0	0.0	0.0	0.0	0.0
Total Lost Time (s)	7.0	7.0	7.0	7.0	7.0
Lead/Lag					
Lead-Lag Optimize?					
Recall Mode	C-Max	C-Max	Max	None	None
v/c Ratio	0.43	0.27	0.24	0.34	0.47
Control Delay	6.8	2.5	2.4	94.9	25.6
Queue Delay	0.0	0.0	0.0	0.0	0.0
Total Delay	6.8	2.5	2.4	94.9	25.6
Queue Length 50th (m)	11.3	24.9	20.6	12.9	0.0
Queue Length 95th (m)	22.8	29.8	25.0	26.6	18.9
Internal Link Dist (m)		619.0	290.4	250.9	
Turn Bay Length (m)	30.0			30.0	
Base Capacity (vph)	371	4375	4327	166	211
Starvation Cap Reductn	0	0	0	0	0
Spillback Cap Reductn	0	0	0	0	0
Storage Cap Reductn	0	0	0	0	0
Reduced v/c Ratio	0.43	0.27	0.24	0.20	0.34

Intersection Summary

Cycle Length: 190
 Actuated Cycle Length: 190
 Offset: 0 (0%), Referenced to phase 2:EBTL, Start of Green
 Natural Cycle: 65
 Control Type: Actuated-Coordinated

Splits and Phases: 24: Mayfield Road & Triangle Lands



HCM Signalized Intersection Capacity Analysis

24: Mayfield Road & Triangle Lands

Future Background (2043) - Optimized
AM Peak Hour

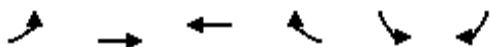

Movement	EBL	EBT	WBT	WBR	SBL	SBR
Lane Configurations	↖	↑↑↑	↑↑↑↗		↙	↘
Traffic Volume (vph)	160	1174	943	108	33	72
Future Volume (vph)	160	1174	943	108	33	72
Ideal Flow (vphpl)	1900	1900	1900	1900	1900	1900
Lane Width	3.0	3.5	3.5	3.0	3.0	3.0
Total Lost time (s)	7.0	7.0	7.0		7.0	7.0
Lane Util. Factor	1.00	0.91	0.91		1.00	1.00
Frt	1.00	1.00	0.98		1.00	0.85
Flt Protected	0.95	1.00	1.00		0.95	1.00
Satd. Flow (prot)	1574	5079	5014		1504	1334
Flt Permitted	0.26	1.00	1.00		0.95	1.00
Satd. Flow (perm)	431	5079	5014		1504	1334
Peak-hour factor, PHF	1.00	1.00	1.00	1.00	1.00	1.00
Adj. Flow (vph)	160	1174	943	108	33	72
RTOR Reduction (vph)	0	0	6	0	0	67
Lane Group Flow (vph)	160	1174	1045	0	33	5
Heavy Vehicles (%)	7%	1%	0%	7%	12%	13%
Turn Type	Perm	NA	NA		Prot	Perm
Protected Phases		2	6		4	
Permitted Phases	2					4
Actuated Green, G (s)	163.7	163.7	163.7		12.3	12.3
Effective Green, g (s)	163.7	163.7	163.7		12.3	12.3
Actuated g/C Ratio	0.86	0.86	0.86		0.06	0.06
Clearance Time (s)	7.0	7.0	7.0		7.0	7.0
Vehicle Extension (s)	3.0	3.0	3.0		3.0	3.0
Lane Grp Cap (vph)	371	4375	4319		97	86
v/s Ratio Prot		0.23	0.21		c0.02	
v/s Ratio Perm	c0.37					0.00
v/c Ratio	0.43	0.27	0.24		0.34	0.05
Uniform Delay, d1	2.9	2.4	2.3		85.0	83.4
Progression Factor	1.00	1.00	1.00		1.00	1.00
Incremental Delay, d2	3.6	0.2	0.1		2.1	0.3
Delay (s)	6.5	2.5	2.4		87.1	83.7
Level of Service	A	A	A		F	F
Approach Delay (s)		3.0	2.4		84.7	
Approach LOS		A	A		F	













Intersection Summary

HCM 2000 Control Delay	6.2	HCM 2000 Level of Service	A
HCM 2000 Volume to Capacity ratio	0.42		
Actuated Cycle Length (s)	190.0	Sum of lost time (s)	14.0
Intersection Capacity Utilization	58.1%	ICU Level of Service	B
Analysis Period (min)	15		

c Critical Lane Group

HCM Unsignalized Intersection Capacity Analysis
 26: Humber Station Road & Subject Lands Site Access #3

Future Background (2043) - Optimized
 AM Peak Hour

						
Movement	WBL	WBR	NBT	NBR	SBL	SBT
Lane Configurations						
Traffic Volume (veh/h)	0	0	99	0	0	332
Future Volume (Veh/h)	0	0	99	0	0	332
Sign Control	Stop		Free		Free	
Grade	0%		0%		0%	
Peak Hour Factor	1.00	1.00	1.00	1.00	1.00	1.00
Hourly flow rate (vph)	0	0	99	0	0	332
Pedestrians						
Lane Width (m)						
Walking Speed (m/s)						
Percent Blockage						
Right turn flare (veh)						
Median type			None		None	
Median storage veh						
Upstream signal (m)						
pX, platoon unblocked						
vC, conflicting volume	431	99			99	
vC1, stage 1 conf vol						
vC2, stage 2 conf vol						
vCu, unblocked vol	431	99			99	
tC, single (s)	6.4	6.2			4.1	
tC, 2 stage (s)						
tF (s)	3.5	3.3			2.2	
p0 queue free %	100	100			100	
cM capacity (veh/h)	585	962			1507	
Direction, Lane #	WB 1	WB 2	NB 1	NB 2	SB 1	SB 2
Volume Total	0	0	99	0	0	332
Volume Left	0	0	0	0	0	0
Volume Right	0	0	0	0	0	0
cSH	1700	1700	1700	1700	1700	1700
Volume to Capacity	0.00	0.00	0.06	0.00	0.00	0.20
Queue Length 95th (m)	0.0	0.0	0.0	0.0	0.0	0.0
Control Delay (s)	0.0	0.0	0.0	0.0	0.0	0.0
Lane LOS	A	A				
Approach Delay (s)	0.0		0.0		0.0	
Approach LOS	A					
Intersection Summary						
Average Delay			0.0			
Intersection Capacity Utilization			20.8%		ICU Level of Service	A
Analysis Period (min)			15			

Queues
 27: Subject Lands Site Access #4 & Healey Road

Future Background (2043) - Optimized
 AM Peak Hour

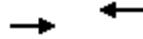

Lane Group	EBT	WBT	Ø2
Lane Configurations	↗	↖	
Traffic Volume (vph)	1067	546	
Future Volume (vph)	1067	546	
Lane Group Flow (vph)	1067	546	
Turn Type	NA	NA	
Protected Phases	4	8	2
Permitted Phases			
Detector Phase	4	8	
Switch Phase			
Minimum Initial (s)	8.0	8.0	8.0
Minimum Split (s)	24.8	24.8	24.7
Total Split (s)	95.0	95.0	25.0
Total Split (%)	79.2%	79.2%	21%
Yellow Time (s)	4.0	4.0	4.6
All-Red Time (s)	2.8	2.8	2.1
Lost Time Adjust (s)	0.0	0.0	
Total Lost Time (s)	6.8	6.8	
Lead/Lag			
Lead-Lag Optimize?			
Recall Mode	C-Max	C-Max	None
v/c Ratio	0.57	0.29	
Control Delay	1.1	0.4	
Queue Delay	0.0	0.0	
Total Delay	1.1	0.4	
Queue Length 50th (m)	0.0	0.0	
Queue Length 95th (m)	m0.0	0.0	
Internal Link Dist (m)	505.1	823.7	
Turn Bay Length (m)			
Base Capacity (vph)	1879	1879	
Starvation Cap Reductn	0	0	
Spillback Cap Reductn	0	0	
Storage Cap Reductn	0	0	
Reduced v/c Ratio	0.57	0.29	

Intersection Summary

Cycle Length: 120
 Actuated Cycle Length: 120
 Offset: 0 (0%), Referenced to phase 4:EBT and 8:WBTL, Start of Green
 Natural Cycle: 80
 Control Type: Actuated-Coordinated
 m Volume for 95th percentile queue is metered by upstream signal.

Splits and Phases: 27: Subject Lands Site Access #4 & Healey Road

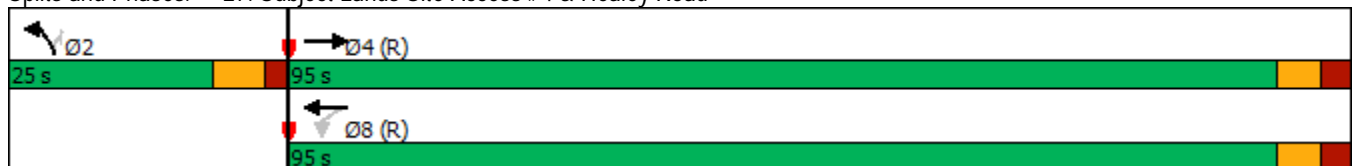

HCM Signalized Intersection Capacity Analysis
 27: Subject Lands Site Access #4 & Healey Road

Future Background (2043) - Optimized
 AM Peak Hour



Movement	EBT	EBR	WBL	WBT	NBL	NBR
Lane Configurations	↻		↻	↻	↻	↻
Traffic Volume (vph)	1067	0	0	546	0	0
Future Volume (vph)	1067	0	0	546	0	0
Ideal Flow (vphpl)	1900	1900	1900	1900	1900	1900
Lane Width	3.5	3.0	3.0	3.5	3.0	3.0
Total Lost time (s)	6.8			6.8		
Lane Util. Factor	1.00			1.00		
Frt	1.00			1.00		
Flt Protected	1.00			1.00		
Satd. Flow (prot)	1879			1879		
Flt Permitted	1.00			1.00		
Satd. Flow (perm)	1879			1879		
Peak-hour factor, PHF	1.00	1.00	1.00	1.00	1.00	1.00
Adj. Flow (vph)	1067	0	0	546	0	0
RTOR Reduction (vph)	0	0	0	0	0	0
Lane Group Flow (vph)	1067	0	0	546	0	0
Heavy Vehicles (%)	0%	0%	0%	0%	0%	0%
Turn Type	NA		Perm	NA	Prot	Perm
Protected Phases	4			8	2	
Permitted Phases			8			2
Actuated Green, G (s)	120.0			120.0		
Effective Green, g (s)	120.0			120.0		
Actuated g/C Ratio	1.00			1.00		
Clearance Time (s)	6.8			6.8		
Vehicle Extension (s)	3.0			3.0		
Lane Grp Cap (vph)	1879			1879		
v/s Ratio Prot	c0.57			0.29		
v/s Ratio Perm						
v/c Ratio	0.57			0.29		
Uniform Delay, d1	0.0			0.0		
Progression Factor	1.00			1.00		
Incremental Delay, d2	0.7			0.4		
Delay (s)	0.7			0.4		
Level of Service	A			A		
Approach Delay (s)	0.7			0.4	0.0	
Approach LOS	A			A	A	













Intersection Summary

HCM 2000 Control Delay	0.6	HCM 2000 Level of Service	A
HCM 2000 Volume to Capacity ratio	0.64		
Actuated Cycle Length (s)	120.0	Sum of lost time (s)	13.5
Intersection Capacity Utilization	61.8%	ICU Level of Service	B
Analysis Period (min)	15		

c Critical Lane Group

HCM Unsignalized Intersection Capacity Analysis
 28: Humber Station Road & Subject Lands Site Access #2

Future Background (2043) - Optimized
 AM Peak Hour

						
Movement	WBL	WBR	NBT	NBR	SBL	SBT
Lane Configurations						
Sign Control	Stop		Stop			Stop
Traffic Volume (vph)	0	0	99	0	0	332
Future Volume (vph)	0	0	99	0	0	332
Peak Hour Factor	1.00	1.00	1.00	1.00	1.00	1.00
Hourly flow rate (vph)	0	0	99	0	0	332
Direction, Lane #	WB 1	WB 2	NB 1	NB 2	SB 1	SB 2
Volume Total (vph)	0	0	99	0	0	332
Volume Left (vph)	0	0	0	0	0	0
Volume Right (vph)	0	0	0	0	0	0
Hadj (s)	0.00	0.00	0.03	0.00	0.00	0.00
Departure Headway (s)	5.5	5.5	4.8	4.7	4.6	4.6
Degree Utilization, x	0.00	0.00	0.13	0.00	0.00	0.42
Capacity (veh/h)	607	607	744	767	793	780
Control Delay (s)	7.3	7.3	7.3	6.5	6.4	9.7
Approach Delay (s)	0.0		7.3		9.7	
Approach LOS	A		A		A	
Intersection Summary						
Delay			9.1			
Level of Service			A			
Intersection Capacity Utilization			20.8%		ICU Level of Service	A
Analysis Period (min)			15			

HCM Unsignalized Intersection Capacity Analysis
 29: Mayfield Road & Subject Lands Site Access #5

Future Background (2043) - Optimized
 AM Peak Hour



Movement	EBL	EBT	WBT	WBR	SBL	SBR				
Lane Configurations	↗	↑↑↑	↑↑↑		↘	↖				
Traffic Volume (veh/h)	0	2021	823	0	0	0				
Future Volume (Veh/h)	0	2021	823	0	0	0				
Sign Control		Free	Free		Stop					
Grade		0%	0%		0%					
Peak Hour Factor	1.00	1.00	1.00	1.00	1.00	1.00				
Hourly flow rate (vph)	0	2021	823	0	0	0				
Pedestrians										
Lane Width (m)										
Walking Speed (m/s)										
Percent Blockage										
Right turn flare (veh)										
Median type		TWLTL	TWLTL							
Median storage veh		2	2							
Upstream signal (m)		270	142							
pX, platoon unblocked	0.97				0.74	0.97				
vC, conflicting volume	823				1497	274				
vC1, stage 1 conf vol					823					
vC2, stage 2 conf vol					674					
vCu, unblocked vol	724				187	161				
tC, single (s)	4.1				6.8	6.9				
tC, 2 stage (s)					5.8					
tF (s)	2.2				3.5	3.3				
p0 queue free %	100				100	100				
cM capacity (veh/h)	864				555	839				
Direction, Lane #	EB 1	EB 2	EB 3	EB 4	WB 1	WB 2	WB 3	SB 1	SB 2	
Volume Total	0	674	674	674	329	329	165	0	0	
Volume Left	0	0	0	0	0	0	0	0	0	
Volume Right	0	0	0	0	0	0	0	0	0	
cSH	1700	1700	1700	1700	1700	1700	1700	1700	1700	
Volume to Capacity	0.00	0.40	0.40	0.40	0.19	0.19	0.10	0.00	0.00	
Queue Length 95th (m)	0.0	0.0	0.0	0.0	0.0	0.0	0.0	0.0	0.0	
Control Delay (s)	0.0	0.0	0.0	0.0	0.0	0.0	0.0	0.0	0.0	
Lane LOS								A	A	
Approach Delay (s)	0.0				0.0			0.0		
Approach LOS								A		
Intersection Summary										
Average Delay			0.0							
Intersection Capacity Utilization			42.4%	ICU Level of Service					A	
Analysis Period (min)			15							

Queues
1: Coleraine Drive & Healey Road

Future Background (2043) -Optimized
PM Peak Hour



Lane Group	EBL	EBT	WBL	WBT	NBL	NBT	SBL	SBT
Lane Configurations	↶	↷	↶	↷	↶	↷	↶	↷
Traffic Volume (vph)	183	268	56	561	400	501	47	187
Future Volume (vph)	183	268	56	561	400	501	47	187
Lane Group Flow (vph)	201	459	62	709	440	608	52	281
Turn Type	pm+pt	NA	Perm	NA	pm+pt	NA	Perm	NA
Protected Phases	3	8		4	1	6		2
Permitted Phases	8		4		6		2	
Detector Phase	3	8	4	4	1	6	2	2
Switch Phase								
Minimum Initial (s)	5.0	8.0	8.0	8.0	5.0	8.0	8.0	8.0
Minimum Split (s)	9.5	32.8	32.8	32.8	9.5	36.7	36.7	36.7
Total Split (s)	20.0	64.0	44.0	44.0	19.0	56.0	37.0	37.0
Total Split (%)	16.7%	53.3%	36.7%	36.7%	15.8%	46.7%	30.8%	30.8%
Yellow Time (s)	3.0	4.0	4.0	4.0	3.0	4.6	4.6	4.6
All-Red Time (s)	0.0	2.8	2.8	2.8	0.0	2.1	2.1	2.1
Lost Time Adjust (s)	0.0	0.0	0.0	0.0	0.0	0.0	0.0	0.0
Total Lost Time (s)	3.0	6.8	6.8	6.8	3.0	6.7	6.7	6.7
Lead/Lag	Lead		Lag	Lag	Lead		Lag	Lag
Lead-Lag Optimize?	Yes		Yes	Yes	Yes		Yes	Yes
Recall Mode	None	None	None	None	None	C-Max	C-Max	C-Max
v/c Ratio	0.79	0.54	0.23	1.16	0.89	0.47	0.33	0.37
Control Delay	43.3	29.1	32.9	126.7	49.2	26.9	43.6	32.9
Queue Delay	0.0	0.0	0.0	0.0	0.0	0.0	0.0	0.0
Total Delay	43.3	29.1	32.9	126.7	49.2	26.9	43.6	32.9
Queue Length 50th (m)	37.8	96.4	11.1	-209.9	81.1	56.1	10.6	25.6
Queue Length 95th (m)	#61.4	124.4	24.0	#296.4	#142.3	73.2	23.4	39.0
Internal Link Dist (m)		823.7		424.0		1711.9		1121.0
Turn Bay Length (m)	55.0		50.0		80.0		155.0	
Base Capacity (vph)	295	855	272	610	495	1282	158	756
Starvation Cap Reductn	0	0	0	0	0	0	0	0
Spillback Cap Reductn	0	0	0	0	0	0	0	0
Storage Cap Reductn	0	0	0	0	0	0	0	0
Reduced v/c Ratio	0.68	0.54	0.23	1.16	0.89	0.47	0.33	0.37

Intersection Summary





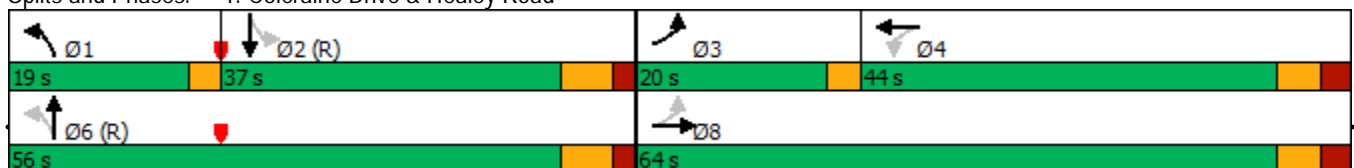

















Cycle Length: 120
 Actuated Cycle Length: 120
 Offset: 31 (26%), Referenced to phase 2:SBTL and 6:NBTL, Start of Green
 Natural Cycle: 120
 Control Type: Actuated-Coordinated
 ~ Volume exceeds capacity, queue is theoretically infinite.
 Queue shown is maximum after two cycles.
 # 95th percentile volume exceeds capacity, queue may be longer.
 Queue shown is maximum after two cycles.

Splits and Phases: 1: Coleraine Drive & Healey Road



HCM Signalized Intersection Capacity Analysis
 1: Coleraine Drive & Healey Road

Future Background (2043) -Optimized
 PM Peak Hour

												
Movement	EBL	EBT	EBR	WBL	WBT	WBR	NBL	NBT	NBR	SBL	SBT	SBR
Lane Configurations												
Traffic Volume (vph)	183	268	149	56	561	85	400	501	52	47	187	69
Future Volume (vph)	183	268	149	56	561	85	400	501	52	47	187	69
Ideal Flow (vphpl)	1900	1900	1900	1900	1900	1900	1900	1900	1900	1900	1900	1900
Lane Width	3.0	3.5	3.0	3.0	3.5	3.0	3.0	3.5	3.0	3.0	3.5	3.0
Total Lost time (s)	3.0	6.8		6.8	6.8		3.0	6.7		6.7	6.7	
Lane Util. Factor	1.00	1.00		1.00	1.00		1.00	0.95		1.00	0.95	
Flt	1.00	0.95		1.00	0.98		1.00	0.99		1.00	0.96	
Flt Protected	0.95	1.00		0.95	1.00		0.95	1.00		0.95	1.00	
Satd. Flow (prot)	1668	1759		1546	1804		1668	3104		1416	2872	
Flt Permitted	0.09	1.00		0.50	1.00		0.50	1.00		0.42	1.00	
Satd. Flow (perm)	162	1759		811	1804		885	3104		629	2872	
Peak-hour factor, PHF	0.91	0.91	0.91	0.91	0.91	0.91	0.91	0.91	0.91	0.91	0.91	0.91
Adj. Flow (vph)	201	295	164	62	616	93	440	551	57	52	205	76
RTOR Reduction (vph)	0	17	0	0	5	0	0	6	0	0	31	0
Lane Group Flow (vph)	201	442	0	62	704	0	440	602	0	52	250	0
Heavy Vehicles (%)	1%	0%	3%	9%	0%	16%	1%	13%	17%	19%	26%	1%
Turn Type	pm+pt	NA		Perm	NA		pm+pt	NA		Perm	NA	
Protected Phases	3	8			4		1	6			2	
Permitted Phases	8			4			6			2		
Actuated Green, G (s)	57.2	57.2		40.3	40.3		49.3	49.3		30.3	30.3	
Effective Green, g (s)	57.2	57.2		40.3	40.3		49.3	49.3		30.3	30.3	
Actuated g/C Ratio	0.48	0.48		0.34	0.34		0.41	0.41		0.25	0.25	
Clearance Time (s)	3.0	6.8		6.8	6.8		3.0	6.7		6.7	6.7	
Vehicle Extension (s)	3.0	3.0		3.0	3.0		3.0	3.0		3.0	3.0	
Lane Grp Cap (vph)	251	838		272	605		467	1275		158	725	
v/s Ratio Prot	c0.09	0.25			c0.39		c0.13	0.19			0.09	
v/s Ratio Perm	0.29			0.08			c0.26			0.08		
v/c Ratio	0.80	0.53		0.23	1.16		0.94	0.47		0.33	0.34	
Uniform Delay, d1	30.9	22.0		28.7	39.9		31.2	25.8		36.6	36.7	
Progression Factor	0.89	1.29		1.00	1.00		1.00	1.00		1.00	1.00	
Incremental Delay, d2	16.2	0.6		0.4	91.0		27.6	1.3		5.5	1.3	
Delay (s)	43.6	28.8		29.1	130.9		58.8	27.1		42.1	38.0	
Level of Service	D	C		C	F		E	C		D	D	
Approach Delay (s)		33.3			122.7			40.4			38.6	
Approach LOS		C			F			D			D	
Intersection Summary												
HCM 2000 Control Delay			61.1				HCM 2000 Level of Service				E	
HCM 2000 Volume to Capacity ratio			1.04									
Actuated Cycle Length (s)			120.0				Sum of lost time (s)				19.5	
Intersection Capacity Utilization			92.3%				ICU Level of Service				F	
Analysis Period (min)			15									

c Critical Lane Group

Queues
2: Humber Station Road & Healey Road

Future Background (2043) -Optimized
PM Peak Hour

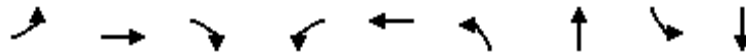

Lane Group	EBL	EBT	EBR	WBL	WBT	NBL	NBT	SBL	SBT
Lane Configurations	↖	↑	↗	↖	↗	↖	↗	↖	↗
Traffic Volume (vph)	21	468	14	34	1108	54	279	26	53
Future Volume (vph)	21	468	14	34	1108	54	279	26	53
Lane Group Flow (vph)	22	482	14	35	1165	56	388	27	61
Turn Type	Perm	NA	Perm	pm+pt	NA	Perm	NA	Perm	NA
Protected Phases		4		3	8		2		6
Permitted Phases	4		4	8		2		6	
Detector Phase	4	4	4	3	8	2	2	6	6
Switch Phase									
Minimum Initial (s)	8.0	8.0	8.0	5.0	8.0	8.0	8.0	8.0	8.0
Minimum Split (s)	24.8	24.8	24.8	8.0	24.8	24.7	24.7	24.7	24.7
Total Split (s)	62.0	62.0	62.0	10.0	72.0	48.0	48.0	48.0	48.0
Total Split (%)	51.7%	51.7%	51.7%	8.3%	60.0%	40.0%	40.0%	40.0%	40.0%
Yellow Time (s)	4.0	4.0	4.0	3.0	4.0	4.6	4.6	4.6	4.6
All-Red Time (s)	2.8	2.8	2.8	0.0	2.8	2.1	2.1	2.1	2.1
Lost Time Adjust (s)	0.0	0.0	0.0	0.0	0.0	0.0	0.0	0.0	0.0
Total Lost Time (s)	6.8	6.8	6.8	3.0	6.8	6.7	6.7	6.7	6.7
Lead/Lag	Lag	Lag	Lag	Lead					
Lead-Lag Optimize?	Yes	Yes	Yes	Yes					
Recall Mode	None	None	None	None	None	C-Max	C-Max	C-Max	C-Max
v/c Ratio	0.38	0.53	0.02	0.09	1.15	0.14	0.62	0.14	0.10
Control Delay	44.5	24.3	0.1	6.3	95.1	33.3	33.4	29.6	25.1
Queue Delay	0.0	0.0	0.0	0.0	0.0	0.0	0.0	0.0	0.0
Total Delay	44.5	24.3	0.1	6.3	95.1	33.3	33.4	29.6	25.1
Queue Length 50th (m)	3.5	84.5	0.0	1.6	~339.2	5.6	37.8	4.6	9.4
Queue Length 95th (m)	#15.8	119.2	0.0	m2.8	#420.7	20.9	96.6	12.3	19.5
Internal Link Dist (m)		465.5			505.1		463.9		452.2
Turn Bay Length (m)	30.0		30.0	60.0		30.0		30.0	
Base Capacity (vph)	58	918	727	401	1017	401	624	193	628
Starvation Cap Reductn	0	0	0	0	0	0	0	0	0
Spillback Cap Reductn	0	0	0	0	0	0	0	0	0
Storage Cap Reductn	0	0	0	0	0	0	0	0	0
Reduced v/c Ratio	0.38	0.53	0.02	0.09	1.15	0.14	0.62	0.14	0.10

Intersection Summary

Cycle Length: 120
 Actuated Cycle Length: 120
 Offset: 11 (9%), Referenced to phase 2:NBTL and 6:SBTL, Start of Green
 Natural Cycle: 90
 Control Type: Actuated-Coordinated
 ~ Volume exceeds capacity, queue is theoretically infinite.
 Queue shown is maximum after two cycles.
 # 95th percentile volume exceeds capacity, queue may be longer.
 Queue shown is maximum after two cycles.
 m Volume for 95th percentile queue is metered by upstream signal.

Splits and Phases: 2: Humber Station Road & Healey Road

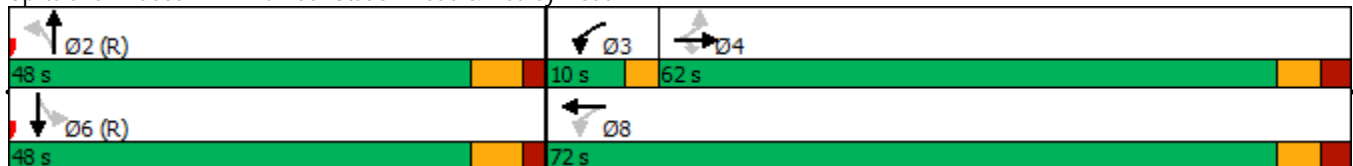

HCM Signalized Intersection Capacity Analysis

2: Humber Station Road & Healey Road

Future Background (2043) -Optimized
PM Peak Hour



Movement	EBL	EBT	EBR	WBL	WBT	WBR	NBL	NBT	NBR	SBL	SBT	SBR
Lane Configurations												
Traffic Volume (vph)	21	468	14	34	1108	22	54	279	97	26	53	6
Future Volume (vph)	21	468	14	34	1108	22	54	279	97	26	53	6
Ideal Flow (vphpl)	1900	1900	1900	1900	1900	1900	1900	1900	1900	1900	1900	1900
Lane Width	3.0	3.5	3.0	3.0	3.5	3.0	3.0	3.5	3.0	3.0	3.5	3.0
Total Lost time (s)	6.8	6.8	6.8	3.0	6.8		6.7	6.7		6.7	6.7	
Lane Util. Factor	1.00	1.00	1.00	1.00	1.00		1.00	1.00		1.00	1.00	
Frt	1.00	1.00	0.85	1.00	1.00		1.00	0.96		1.00	0.99	
Flt Protected	0.95	1.00	1.00	0.95	1.00		0.95	1.00		0.95	1.00	
Satd. Flow (prot)	1685	1860	1409	1636	1871		1546	1784		1620	1818	
Flt Permitted	0.07	1.00	1.00	0.34	1.00		0.72	1.00		0.33	1.00	
Satd. Flow (perm)	120	1860	1409	592	1871		1167	1784		562	1818	
Peak-hour factor, PHF	0.97	0.97	0.97	0.97	0.97	0.97	0.97	0.97	0.97	0.97	0.97	0.97
Adj. Flow (vph)	22	482	14	35	1142	23	56	288	100	27	55	6
RTOR Reduction (vph)	0	0	7	0	0	0	0	11	0	0	3	0
Lane Group Flow (vph)	22	482	7	35	1165	0	56	377	0	27	58	0
Heavy Vehicles (%)	0%	1%	7%	3%	0%	5%	9%	1%	2%	4%	2%	0%
Turn Type	Perm	NA	Perm	pm+pt	NA		Perm	NA		Perm	NA	
Protected Phases		4		3	8			2			6	
Permitted Phases	4		4	8			2			6		
Actuated Green, G (s)	59.3	59.3	59.3	66.4	66.4		40.1	40.1		40.1	40.1	
Effective Green, g (s)	59.3	59.3	59.3	66.4	66.4		40.1	40.1		40.1	40.1	
Actuated g/C Ratio	0.49	0.49	0.49	0.55	0.55		0.33	0.33		0.33	0.33	
Clearance Time (s)	6.8	6.8	6.8	3.0	6.8		6.7	6.7		6.7	6.7	
Vehicle Extension (s)	3.0	3.0	3.0	3.0	3.0		3.0	3.0		3.0	3.0	
Lane Grp Cap (vph)	59	919	696	363	1035		389	596		187	607	
v/s Ratio Prot		0.26		0.00	c0.62			c0.21			0.03	
v/s Ratio Perm	0.18		0.00	0.05			0.05			0.05		
v/c Ratio	0.37	0.52	0.01	0.10	1.13		0.14	0.63		0.14	0.10	
Uniform Delay, d1	18.8	20.7	15.4	13.7	26.8		27.9	33.7		27.9	27.5	
Progression Factor	1.00	1.00	1.00	0.53	0.62		1.18	0.90		1.00	1.00	
Incremental Delay, d2	3.9	0.5	0.0	0.1	66.9		0.8	5.0		1.6	0.3	
Delay (s)	22.8	21.3	15.4	7.3	83.5		33.6	35.3		29.6	27.8	
Level of Service	C	C	B	A	F		C	D		C	C	
Approach Delay (s)		21.2			81.3			35.1			28.3	
Approach LOS		C			F			D			C	

Intersection Summary

HCM 2000 Control Delay	56.3	HCM 2000 Level of Service	E
HCM 2000 Volume to Capacity ratio	0.97		
Actuated Cycle Length (s)	120.0	Sum of lost time (s)	16.5
Intersection Capacity Utilization	92.5%	ICU Level of Service	F
Analysis Period (min)	15		

c Critical Lane Group

Queues

3: Clarkway Drive/Humber Station Road & Mayfield Road

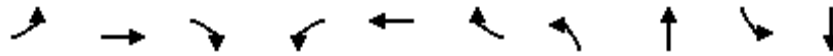

Lane Group	EBL	EBT	EBR	WBL	WBT	WBR	NBL	NBT	SBL	SBT
Lane Configurations	↙	↑↑↑	↘	↙	↑↑↑	↘	↙	↘	↙	↘
Traffic Volume (vph)	10	1232	19	68	1479	42	59	365	10	76
Future Volume (vph)	10	1232	19	68	1479	42	59	365	10	76
Lane Group Flow (vph)	10	1270	20	70	1525	43	61	481	10	90
Turn Type	pm+pt	NA	Perm	Perm	NA	Perm	Perm	NA	pm+pt	NA
Protected Phases	5	2			6			4	3	8
Permitted Phases	2		2	6		6	4		8	
Detector Phase	5	2	2	6	6	6	4	4	3	8
Switch Phase										
Minimum Initial (s)	5.0	12.0	12.0	12.0	12.0	12.0	8.0	8.0	5.0	8.0
Minimum Split (s)	9.5	27.3	27.3	27.3	27.3	27.3	26.0	26.0	9.5	26.0
Total Split (s)	15.0	62.0	62.0	47.0	47.0	47.0	48.0	48.0	10.0	58.0
Total Split (%)	12.5%	51.7%	51.7%	39.2%	39.2%	39.2%	40.0%	40.0%	8.3%	48.3%
Yellow Time (s)	3.0	4.6	4.6	4.6	4.6	4.6	4.2	4.2	3.0	4.2
All-Red Time (s)	0.0	2.7	2.7	2.7	2.7	2.7	2.8	2.8	0.0	2.8
Lost Time Adjust (s)	0.0	0.0	0.0	0.0	0.0	0.0	0.0	0.0	0.0	0.0
Total Lost Time (s)	3.0	7.3	7.3	7.3	7.3	7.3	7.0	7.0	3.0	7.0
Lead/Lag	Lead			Lag	Lag	Lag	Lag	Lag	Lead	
Lead-Lag Optimize?	Yes			Yes	Yes	Yes	Yes	Yes	Yes	
Recall Mode	None	C-Max	C-Max	C-Max	C-Max	C-Max	None	None	None	None
v/c Ratio	0.07	0.46	0.03	0.44	0.57	0.06	0.18	0.89	0.07	0.15
Control Delay	14.0	17.3	0.1	25.8	14.5	0.8	30.8	57.4	17.8	18.8
Queue Delay	0.0	0.0	0.0	0.0	0.0	0.0	0.0	0.0	0.0	0.0
Total Delay	14.0	17.3	0.1	25.8	14.5	0.8	30.8	57.4	17.8	18.8
Queue Length 50th (m)	0.9	63.8	0.0	9.1	75.7	0.3	11.0	109.1	1.2	10.2
Queue Length 95th (m)	4.3	98.2	0.0	#39.8	153.8	1.3	21.4	146.8	3.3	15.6
Internal Link Dist (m)		1635.6			245.9			1187.5		1542.4
Turn Bay Length (m)	150.0		105.0	150.0		115.0			105.0	
Base Capacity (vph)	216	2735	795	160	2655	779	378	620	161	780
Starvation Cap Reductn	0	0	0	0	0	0	0	0	0	0
Spillback Cap Reductn	0	0	0	0	0	0	0	0	0	0
Storage Cap Reductn	0	0	0	0	0	0	0	0	0	0
Reduced v/c Ratio	0.05	0.46	0.03	0.44	0.57	0.06	0.16	0.78	0.06	0.12

Intersection Summary

Cycle Length: 120

Actuated Cycle Length: 120

Offset: 86 (72%), Referenced to phase 2:EBTL and 6:WBTL, Start of Green

Natural Cycle: 90

Control Type: Actuated-Coordinated

95th percentile volume exceeds capacity, queue may be longer.

Queue shown is maximum after two cycles.

Splits and Phases: 3: Clarkway Drive/Humber Station Road & Mayfield Road

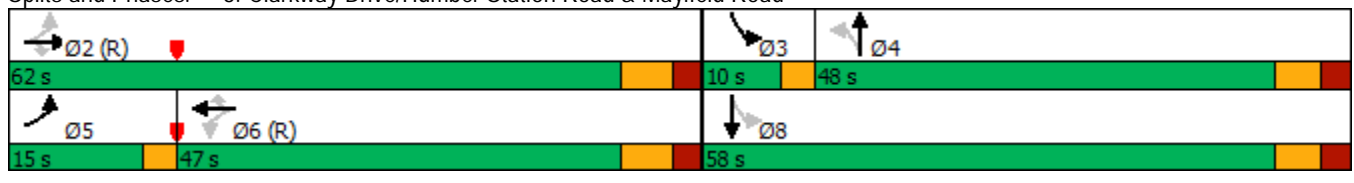

HCM Signalized Intersection Capacity Analysis

Future Background (2043) -Optimized

3: Clarkway Drive/Humber Station Road & Mayfield Road

PM Peak Hour



Movement	EBL	EBT	EBR	WBL	WBT	WBR	NBL	NBT	NBR	SBL	SBT	SBR
Lane Configurations	↘	↑↑↑	↗	↘	↑↑↑	↗	↘	↗		↘	↗	
Traffic Volume (vph)	10	1232	19	68	1479	42	59	365	102	10	76	12
Future Volume (vph)	10	1232	19	68	1479	42	59	365	102	10	76	12
Ideal Flow (vphpl)	1900	1900	1900	1900	1900	1900	1900	1900	1900	1900	1900	1900
Lane Width	3.0	3.5	3.0	3.0	3.5	3.0	3.0	3.5	3.0	3.0	3.5	3.0
Total Lost time (s)	3.0	7.3	7.3	7.3	7.3	7.3	7.0	7.0		3.0	7.0	
Lane Util. Factor	1.00	0.91	1.00	1.00	0.91	1.00	1.00	1.00		1.00	1.00	
Fr _t	1.00	1.00	0.85	1.00	1.00	0.85	1.00	0.97		1.00	0.98	
Fl _t Protected	0.95	1.00	1.00	0.95	1.00	1.00	0.95	1.00		0.95	1.00	
Satd. Flow (prot)	1404	4839	1358	1532	4839	1346	1504	1788		1532	1825	
Fl _t Permitted	0.10	1.00	1.00	0.18	1.00	1.00	0.70	1.00		0.15	1.00	
Satd. Flow (perm)	152	4839	1358	293	4839	1346	1106	1788		248	1825	
Peak-hour factor, PHF	0.97	0.97	0.97	0.97	0.97	0.97	0.97	0.97	0.97	0.97	0.97	0.97
Adj. Flow (vph)	10	1270	20	70	1525	43	61	376	105	10	78	12
RTOR Reduction (vph)	0	0	9	0	0	21	0	9	0	0	5	0
Lane Group Flow (vph)	10	1270	11	70	1525	22	61	472	0	10	85	0
Heavy Vehicles (%)	20%	6%	11%	10%	6%	12%	12%	1%	4%	10%	1%	0%
Turn Type	pm+pt	NA	Perm	Perm	NA	Perm	Perm	NA		pm+pt	NA	
Protected Phases	5	2			6			4		3	8	
Permitted Phases	2		2	6		6	4			8		
Actuated Green, G (s)	65.4	65.4	65.4	61.0	61.0	61.0	35.9	35.9		40.3	40.3	
Effective Green, g (s)	65.4	65.4	65.4	61.0	61.0	61.0	35.9	35.9		40.3	40.3	
Actuated g/C Ratio	0.55	0.55	0.55	0.51	0.51	0.51	0.30	0.30		0.34	0.34	
Clearance Time (s)	3.0	7.3	7.3	7.3	7.3	7.3	7.0	7.0		3.0	7.0	
Vehicle Extension (s)	3.0	3.0	3.0	3.0	3.0	3.0	3.0	3.0		3.0	3.0	
Lane Grp Cap (vph)	97	2637	740	148	2459	684	330	534		98	612	
v/s Ratio Prot	0.00	c0.26			c0.32			c0.26		0.00	c0.05	
v/s Ratio Perm	0.05		0.01	0.24		0.02	0.06			0.03		
v/c Ratio	0.10	0.48	0.01	0.47	0.62	0.03	0.18	0.88		0.10	0.14	
Uniform Delay, d ₁	14.7	16.8	12.5	19.1	21.2	14.7	31.2	40.1		29.6	27.8	
Progression Factor	1.00	1.00	1.00	0.68	0.67	1.00	1.00	1.00		0.80	0.74	
Incremental Delay, d ₂	0.5	0.6	0.0	10.0	1.1	0.1	0.3	15.9		0.5	0.1	
Delay (s)	15.1	17.5	12.6	22.9	15.4	14.8	31.5	55.9		24.1	20.8	
Level of Service	B	B	B	C	B	B	C	E		C	C	
Approach Delay (s)		17.4			15.7			53.2			21.1	
Approach LOS		B			B			D			C	

Intersection Summary

HCM 2000 Control Delay	22.1	HCM 2000 Level of Service	C
HCM 2000 Volume to Capacity ratio	0.71		
Actuated Cycle Length (s)	120.0	Sum of lost time (s)	20.3
Intersection Capacity Utilization	77.2%	ICU Level of Service	D
Analysis Period (min)	15		

c Critical Lane Group

Queues

4: Coleraine Drive & Mayfield Road

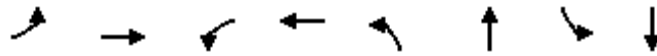

Lane Group	EBL	EBT	WBL	WBT	NBL	NBT	SBL	SBT
Lane Configurations	↶	↶↶↶	↶	↶↶	↶	↶↶	↶	↶↶
Traffic Volume (vph)	338	1051	13	892	26	413	52	201
Future Volume (vph)	338	1051	13	892	26	413	52	201
Lane Group Flow (vph)	356	1121	14	1022	27	457	55	486
Turn Type	pm+pt	NA	Perm	NA	Perm	NA	pm+pt	NA
Protected Phases	5	2		6		4	3	8
Permitted Phases	2		6		4		8	
Detector Phase	5	2	6	6	4	4	3	8
Switch Phase								
Minimum Initial (s)	5.0	12.0	12.0	12.0	12.0	12.0	5.0	12.0
Minimum Split (s)	8.0	37.0	37.0	37.0	37.0	37.0	8.0	37.0
Total Split (s)	28.0	80.0	52.0	52.0	36.0	36.0	14.0	50.0
Total Split (%)	21.5%	61.5%	40.0%	40.0%	27.7%	27.7%	10.8%	38.5%
Yellow Time (s)	3.0	4.6	4.6	4.6	4.2	4.2	3.0	4.2
All-Red Time (s)	0.0	2.4	2.4	2.4	2.8	2.8	0.0	2.8
Lost Time Adjust (s)	0.0	0.0	0.0	0.0	0.0	0.0	0.0	0.0
Total Lost Time (s)	3.0	7.0	7.0	7.0	7.0	7.0	3.0	7.0
Lead/Lag	Lead		Lag	Lag	Lag	Lag	Lead	
Lead-Lag Optimize?	Yes		Yes	Yes	Yes	Yes	Yes	
Recall Mode	None	C-Max	C-Max	C-Max	None	None	None	None
v/c Ratio	0.81	0.35	0.09	0.81	0.19	0.76	0.34	0.51
Control Delay	43.5	11.9	31.1	42.9	48.2	59.7	37.8	18.7
Queue Delay	0.0	0.0	0.0	0.0	0.0	0.0	0.0	0.0
Total Delay	43.5	11.9	31.1	42.9	48.2	59.7	37.8	18.7
Queue Length 50th (m)	66.1	49.7	2.6	135.4	6.3	62.0	10.9	24.7
Queue Length 95th (m)	#133.4	67.9	8.0	#169.7	15.2	77.7	20.4	38.7
Internal Link Dist (m)		290.4		195.1		791.2		576.8
Turn Bay Length (m)	100.0		85.0		105.0		145.0	
Base Capacity (vph)	442	3210	151	1267	187	793	179	1187
Starvation Cap Reductn	0	0	0	0	0	0	0	0
Spillback Cap Reductn	0	0	0	0	0	0	0	0
Storage Cap Reductn	0	0	0	0	0	0	0	0
Reduced v/c Ratio	0.81	0.35	0.09	0.81	0.14	0.58	0.31	0.41

Intersection Summary

Cycle Length: 130
 Actuated Cycle Length: 130
 Offset: 0 (0%), Referenced to phase 2:EBTL and 6:WBTL, Start of Green
 Natural Cycle: 100
 Control Type: Actuated-Coordinated
 # 95th percentile volume exceeds capacity, queue may be longer.
 Queue shown is maximum after two cycles.

Splits and Phases: 4: Coleraine Drive & Mayfield Road

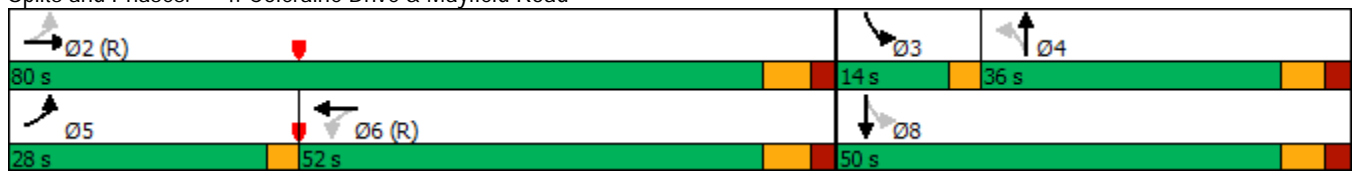

HCM Signalized Intersection Capacity Analysis

4: Coleraine Drive & Mayfield Road

Future Background (2043) -Optimized
PM Peak Hour



Movement	EBL	EBT	EBR	WBL	WBT	WBR	NBL	NBT	NBR	SBL	SBT	SBR
Lane Configurations	↖	↑↑↑		↖	↑↑		↖	↑↑		↖	↑↑	
Traffic Volume (vph)	338	1051	14	13	892	79	26	413	21	52	201	260
Future Volume (vph)	338	1051	14	13	892	79	26	413	21	52	201	260
Ideal Flow (vphpl)	1900	1900	1900	1900	1900	1900	1900	1900	1900	1900	1900	1900
Lane Width	3.0	3.5	3.0	3.0	3.5	3.0	3.0	3.5	3.0	3.0	3.5	3.0
Total Lost time (s)	3.0	7.0		7.0	7.0		7.0	7.0		3.0	7.0	
Lane Util. Factor	1.00	0.91		1.00	0.95		1.00	0.95		1.00	0.95	
Fr _t	1.00	1.00		1.00	0.99		1.00	0.99		1.00	0.92	
Fl _t Protected	0.95	1.00		0.95	1.00		0.95	1.00		0.95	1.00	
Satd. Flow (prot)	1504	4972		1560	3312		1685	3544		1348	3045	
Fl _t Permitted	0.12	1.00		0.24	1.00		0.48	1.00		0.24	1.00	
Satd. Flow (perm)	183	4972		397	3312		842	3544		340	3045	
Peak-hour factor, PHF	0.95	0.95	0.95	0.95	0.95	0.95	0.95	0.95	0.95	0.95	0.95	0.95
Adj. Flow (vph)	356	1106	15	14	939	83	27	435	22	55	212	274
RTOR Reduction (vph)	0	1	0	0	5	0	0	3	0	0	202	0
Lane Group Flow (vph)	356	1120	0	14	1017	0	27	454	0	55	284	0
Heavy Vehicles (%)	12%	3%	0%	8%	5%	23%	0%	0%	0%	25%	0%	13%
Turn Type	pm+pt	NA		Perm	NA		Perm	NA		pm+pt	NA	
Protected Phases	5	2			6			4		3	8	
Permitted Phases	2			6			4			8		
Actuated Green, G (s)	83.3	83.3		48.9	48.9		21.9	21.9		32.7	32.7	
Effective Green, g (s)	83.3	83.3		48.9	48.9		21.9	21.9		32.7	32.7	
Actuated g/C Ratio	0.64	0.64		0.38	0.38		0.17	0.17		0.25	0.25	
Clearance Time (s)	3.0	7.0		7.0	7.0		7.0	7.0		3.0	7.0	
Vehicle Extension (s)	3.0	3.0		3.0	3.0		3.0	3.0		3.0	3.0	
Lane Grp Cap (vph)	436	3185		149	1245		141	597		146	765	
v/s Ratio Prot	c0.20	0.23			0.31			c0.13		0.02	c0.09	
v/s Ratio Perm	c0.33			0.04			0.03			0.07		
v/c Ratio	0.82	0.35		0.09	0.82		0.19	0.76		0.38	0.37	
Uniform Delay, d ₁	31.8	10.8		26.2	36.5		46.4	51.5		38.6	40.2	
Progression Factor	1.00	1.00		1.00	1.00		1.00	1.00		1.00	1.00	
Incremental Delay, d ₂	11.3	0.3		1.2	6.0		0.7	5.5		1.6	0.3	
Delay (s)	43.1	11.1		27.5	42.5		47.1	57.1		40.3	40.5	
Level of Service	D	B		C	D		D	E		D	D	
Approach Delay (s)		18.8			42.3			56.5			40.4	
Approach LOS		B			D			E			D	

Intersection Summary

HCM 2000 Control Delay	34.2	HCM 2000 Level of Service	C
HCM 2000 Volume to Capacity ratio	0.79		
Actuated Cycle Length (s)	130.0	Sum of lost time (s)	20.0
Intersection Capacity Utilization	90.7%	ICU Level of Service	E
Analysis Period (min)	15		

c Critical Lane Group

Queues

Future Background (2043) -Optimized

5: Coleraine Drive & Private Access/George Bolton Parkway

PM Peak Hour



Lane Group	EBL	EBT	WBL	WBT	NBL	NBT	SBL	SBT	SBR
Lane Configurations	↶	↷	↶	↷	↶	↷	↶	↷	↷
Traffic Volume (vph)	7	26	61	9	6	497	145	499	1
Future Volume (vph)	7	26	61	9	6	497	145	499	1
Lane Group Flow (vph)	8	58	73	198	7	683	175	601	1
Turn Type	Perm	NA	Perm	NA	Perm	NA	Perm	NA	Perm
Protected Phases		8		4		6		2	
Permitted Phases	8		4		6		2		2
Detector Phase	8	8	4	4	6	6	2	2	2
Switch Phase									
Minimum Initial (s)	8.0	8.0	12.0	12.0	12.0	12.0	12.0	12.0	12.0
Minimum Split (s)	32.5	32.5	32.5	32.5	34.2	34.2	33.7	33.7	33.7
Total Split (s)	45.0	45.0	45.0	45.0	55.0	55.0	55.0	55.0	55.0
Total Split (%)	45.0%	45.0%	45.0%	45.0%	55.0%	55.0%	55.0%	55.0%	55.0%
Yellow Time (s)	4.0	4.0	4.0	4.0	4.2	4.2	4.2	4.2	4.2
All-Red Time (s)	3.5	3.5	3.5	3.5	2.5	2.5	2.5	2.5	2.5
Lost Time Adjust (s)	0.0	0.0	0.0	0.0	0.0	0.0	0.0	0.0	0.0
Total Lost Time (s)	7.5	7.5	7.5	7.5	6.7	6.7	6.7	6.7	6.7
Lead/Lag									
Lead-Lag Optimize?									
Recall Mode	None	None	None	None	C-Max	C-Max	C-Max	C-Max	C-Max
v/c Ratio	0.07	0.24	0.48	0.54	0.02	0.31	0.37	0.26	0.00
Control Delay	37.4	25.7	50.0	12.8	4.8	5.4	8.4	5.3	0.0
Queue Delay	0.0	0.0	0.0	0.0	0.0	0.0	0.0	0.0	0.0
Total Delay	37.4	25.7	50.0	12.8	4.8	5.4	8.4	5.3	0.0
Queue Length 50th (m)	1.5	5.8	14.2	2.0	0.3	19.9	10.7	17.5	0.0
Queue Length 95th (m)	5.3	14.8	24.9	16.8	1.7	30.8	23.9	27.3	0.0
Internal Link Dist (m)		152.4		468.8		784.9		1711.9	
Turn Bay Length (m)	70.0		105.0		75.0		100.0		100.0
Base Capacity (vph)	322	619	423	675	362	2225	476	2280	1101
Starvation Cap Reductn	0	0	0	0	0	0	0	0	0
Spillback Cap Reductn	0	0	0	0	0	0	0	0	0
Storage Cap Reductn	0	0	0	0	0	0	0	0	0
Reduced v/c Ratio	0.02	0.09	0.17	0.29	0.02	0.31	0.37	0.26	0.00

Intersection Summary

Cycle Length: 100

Actuated Cycle Length: 100

Offset: 0 (0%), Referenced to phase 2:SBTL and 6:NBTL, Start of Green

Natural Cycle: 70

Control Type: Actuated-Coordinated

Splits and Phases: 5: Coleraine Drive & Private Access/George Bolton Parkway

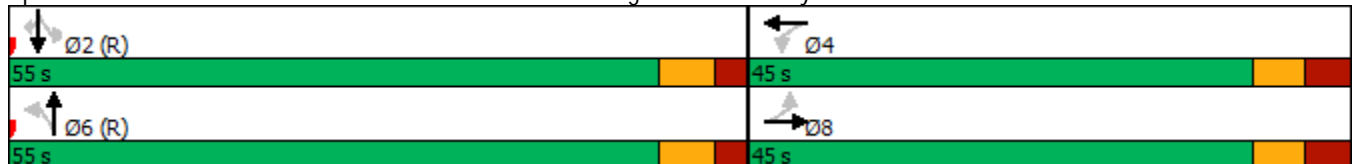

HCM Signalized Intersection Capacity Analysis

Future Background (2043) -Optimized

5: Coleraine Drive & Private Access/George Bolton Parkway

PM Peak Hour



Movement	EBL	EBT	EBR	WBL	WBT	WBR	NBL	NBT	NBR	SBL	SBT	SBR
Lane Configurations	↖	↗		↖	↗		↖	↕		↖	↗	↖
Traffic Volume (vph)	7	26	22	61	9	155	6	497	70	145	499	1
Future Volume (vph)	7	26	22	61	9	155	6	497	70	145	499	1
Ideal Flow (vphpl)	1900	1900	1900	1900	1900	1900	1900	1900	1900	1900	1900	1900
Lane Width	3.0	3.5	3.0	3.0	3.5	3.0	3.0	3.5	3.0	3.0	3.5	3.0
Total Lost time (s)	7.5	7.5		7.5	7.5		6.7	6.7		6.7	6.7	6.7
Lane Util. Factor	1.00	1.00		1.00	1.00		1.00	0.95		1.00	0.95	1.00
Fr _t	1.00	0.93		1.00	0.86		1.00	0.98		1.00	1.00	0.85
Fl _t Protected	0.95	1.00		0.95	1.00		0.95	1.00		0.95	1.00	1.00
Satd. Flow (prot)	1685	1608		1491	1491		1123	3074		1604	3159	1507
Fl _t Permitted	0.49	1.00		0.72	1.00		0.42	1.00		0.39	1.00	1.00
Satd. Flow (perm)	861	1608		1129	1491		502	3074		660	3159	1507
Peak-hour factor, PHF	0.83	0.83	0.83	0.83	0.83	0.83	0.83	0.83	0.83	0.83	0.83	0.83
Adj. Flow (vph)	8	31	27	73	11	187	7	599	84	175	601	1
RTOR Reduction (vph)	0	23	0	0	162	0	0	6	0	0	0	0
Lane Group Flow (vph)	8	35	0	73	36	0	7	677	0	175	601	1
Heavy Vehicles (%)	0%	4%	14%	13%	11%	8%	50%	14%	14%	5%	13%	0%
Turn Type	Perm	NA		Perm	NA		Perm	NA		Perm	NA	Perm
Protected Phases		8			4			6			2	
Permitted Phases	8			4			6			2		2
Actuated Green, G (s)	13.6	13.6		13.6	13.6		72.2	72.2		72.2	72.2	72.2
Effective Green, g (s)	13.6	13.6		13.6	13.6		72.2	72.2		72.2	72.2	72.2
Actuated g/C Ratio	0.14	0.14		0.14	0.14		0.72	0.72		0.72	0.72	0.72
Clearance Time (s)	7.5	7.5		7.5	7.5		6.7	6.7		6.7	6.7	6.7
Vehicle Extension (s)	3.0	3.0		3.0	3.0		3.0	3.0		3.0	3.0	3.0
Lane Grp Cap (vph)	117	218		153	202		362	2219		476	2280	1088
v/s Ratio Prot		0.02			0.02			0.22			0.19	
v/s Ratio Perm	0.01			c0.06			0.01			c0.27		0.00
v/c Ratio	0.07	0.16		0.48	0.18		0.02	0.31		0.37	0.26	0.00
Uniform Delay, d ₁	37.7	38.1		39.9	38.3		3.9	5.0		5.3	4.8	3.9
Progression Factor	1.00	1.00		1.00	1.00		1.00	1.00		1.00	1.00	1.00
Incremental Delay, d ₂	0.2	0.3		2.3	0.4		0.1	0.4		2.2	0.3	0.0
Delay (s)	37.9	38.5		42.3	38.7		4.0	5.3		7.4	5.1	3.9
Level of Service	D	D		D	D		A	A		A	A	A
Approach Delay (s)		38.4			39.7			5.3			5.6	
Approach LOS		D			D			A			A	

Intersection Summary

HCM 2000 Control Delay	11.8	HCM 2000 Level of Service	B
HCM 2000 Volume to Capacity ratio	0.38		
Actuated Cycle Length (s)	100.0	Sum of lost time (s)	14.2
Intersection Capacity Utilization	53.4%	ICU Level of Service	A
Analysis Period (min)	15		

c Critical Lane Group

Queues

6: Highway 50 & George Bolton Parkway/Private Access



Lane Group	EBL	EBT	WBT	NBL	NBT	SBL	SBT	SBR
Lane Configurations								
Traffic Volume (vph)	209	0	0	157	1534	1	983	169
Future Volume (vph)	209	0	0	157	1534	1	983	169
Lane Group Flow (vph)	218	201	7	164	1598	1	1024	176
Turn Type	Perm	NA	NA	pm+pt	NA	Perm	NA	Perm
Protected Phases		8	4	1	6		2	
Permitted Phases	8			6		2		2
Detector Phase	8	8	4	1	6	2	2	2
Switch Phase								
Minimum Initial (s)	8.0	8.0	8.0	5.0	12.0	12.0	12.0	12.0
Minimum Split (s)	32.6	32.6	32.6	8.0	27.3	27.3	27.3	27.3
Total Split (s)	35.0	35.0	35.0	10.0	85.0	75.0	75.0	75.0
Total Split (%)	29.2%	29.2%	29.2%	8.3%	70.8%	62.5%	62.5%	62.5%
Yellow Time (s)	4.0	4.0	4.0	3.0	4.0	4.0	4.0	4.0
All-Red Time (s)	2.6	2.6	2.6	0.0	2.3	2.3	2.3	2.3
Lost Time Adjust (s)	0.0	0.0	0.0	0.0	0.0	0.0	0.0	0.0
Total Lost Time (s)	6.6	6.6	6.6	3.0	6.3	6.3	6.3	6.3
Lead/Lag				Lead		Lag	Lag	Lag
Lead-Lag Optimize?				Yes		Yes	Yes	Yes
Recall Mode	None	None	None	None	C-Max	C-Max	C-Max	C-Max
v/c Ratio	0.83	0.47	0.02	0.53	0.67	0.01	0.49	0.19
Control Delay	70.6	9.8	0.1	12.5	13.0	11.0	15.0	2.2
Queue Delay	0.0	0.0	0.0	0.0	0.0	0.0	0.0	0.0
Total Delay	70.6	9.8	0.1	12.5	13.0	11.0	15.0	2.2
Queue Length 50th (m)	51.6	1.6	0.0	11.7	111.3	0.1	76.0	0.0
Queue Length 95th (m)	#78.9	21.6	0.0	21.7	149.7	1.0	94.9	9.7
Internal Link Dist (m)		846.5	43.0		1045.6		1307.8	
Turn Bay Length (m)	85.0			40.0		135.0		60.0
Base Capacity (vph)	315	479	428	310	2385	134	2095	942
Starvation Cap Reductn	0	0	0	0	0	0	0	0
Spillback Cap Reductn	0	0	0	0	0	0	0	0
Storage Cap Reductn	0	0	0	0	0	0	0	0
Reduced v/c Ratio	0.69	0.42	0.02	0.53	0.67	0.01	0.49	0.19

Intersection Summary





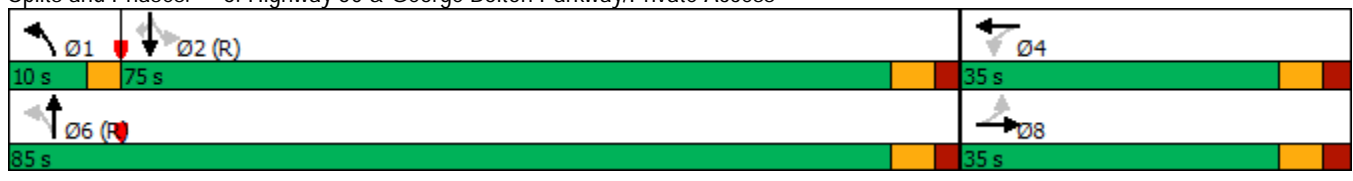















Cycle Length: 120
 Actuated Cycle Length: 120
 Offset: 0 (0%), Referenced to phase 2:SBTL and 6:NBTL, Start of Green
 Natural Cycle: 80
 Control Type: Actuated-Coordinated
 # 95th percentile volume exceeds capacity, queue may be longer.
 Queue shown is maximum after two cycles.

Splits and Phases: 6: Highway 50 & George Bolton Parkway/Private Access



HCM Signalized Intersection Capacity Analysis
6: Highway 50 & George Bolton Parkway/Private Access

Future Background (2043) -Optimized
PM Peak Hour

														
Movement	EBL	EBT	EBR	WBL	WBT	WBR	NBL	NBT	NBR	SBL	SBT	SBR		
Lane Configurations														
Traffic Volume (vph)	209	0	193	0	0	7	157	1534	0	1	983	169		
Future Volume (vph)	209	0	193	0	0	7	157	1534	0	1	983	169		
Ideal Flow (vphpl)	1900	1900	1900	1900	1900	1900	1900	1900	1900	1900	1900	1900		
Lane Width	3.0	3.5	3.0	3.0	3.5	3.0	3.0	3.5	3.0	3.0	3.5	3.0		
Total Lost time (s)	6.6	6.6			6.6		3.0	6.3		6.3	6.3	6.3		
Lane Util. Factor	1.00	1.00			1.00		1.00	0.95		1.00	0.95	1.00		
Frbp, ped/bikes	1.00	0.99			1.00		1.00	1.00		1.00	1.00	0.98		
Flpb, ped/bikes	1.00	1.00			1.00		1.00	1.00		1.00	1.00	1.00		
Frt	1.00	0.85			0.86		1.00	1.00		1.00	1.00	0.85		
Flt Protected	0.95	1.00			1.00		0.95	1.00		0.95	1.00	1.00		
Satd. Flow (prot)	1685	1405			1625		1440	3433		1685	3466	1444		
Flt Permitted	0.75	1.00			1.00		0.22	1.00		0.12	1.00	1.00		
Satd. Flow (perm)	1336	1405			1625		329	3433		221	3466	1444		
Peak-hour factor, PHF	0.96	0.96	0.96	0.96	0.96	0.96	0.96	0.96	0.96	0.96	0.96	0.96		
Adj. Flow (vph)	218	0	201	0	0	7	164	1598	0	1	1024	176		
RTOR Reduction (vph)	0	155	0	0	6	0	0	0	0	0	0	70		
Lane Group Flow (vph)	218	46	0	0	1	0	164	1598	0	1	1024	106		
Confl. Peds. (#/hr)			2	2			1					1		
Heavy Vehicles (%)	0%	0%	12%	0%	0%	0%	17%	4%	0%	0%	3%	2%		
Turn Type	Perm	NA			NA		pm+pt	NA		Perm	NA	Perm		
Protected Phases		8			4		1	6			2			
Permitted Phases	8			4			6			2		2		
Actuated Green, G (s)	23.7	23.7			23.7		83.4	83.4		72.6	72.6	72.6		
Effective Green, g (s)	23.7	23.7			23.7		83.4	83.4		72.6	72.6	72.6		
Actuated g/C Ratio	0.20	0.20			0.20		0.70	0.70		0.60	0.60	0.60		
Clearance Time (s)	6.6	6.6			6.6		3.0	6.3		6.3	6.3	6.3		
Vehicle Extension (s)	3.0	3.0			3.0		3.0	3.0		3.0	3.0	3.0		
Lane Grp Cap (vph)	263	277			320		300	2385		133	2096	873		
v/s Ratio Prot		0.03			0.00		0.04	c0.47			0.30			
v/s Ratio Perm	c0.16						0.34			0.00		0.07		
v/c Ratio	0.83	0.17			0.00		0.55	0.67		0.01	0.49	0.12		
Uniform Delay, d1	46.2	40.0			38.7		8.3	10.4		9.4	13.3	10.1		
Progression Factor	1.00	1.00			1.00		1.00	1.00		1.00	1.00	1.00		
Incremental Delay, d2	18.9	0.3			0.0		2.0	1.5		0.1	0.8	0.3		
Delay (s)	65.1	40.2			38.7		10.3	12.0		9.5	14.1	10.4		
Level of Service	E	D			D		B	B		A	B	B		
Approach Delay (s)		53.2			38.7			11.8			13.6			
Approach LOS		D			D			B			B			
Intersection Summary														
HCM 2000 Control Delay			17.6									HCM 2000 Level of Service	B	
HCM 2000 Volume to Capacity ratio			0.72											
Actuated Cycle Length (s)			120.0								15.9			
Intersection Capacity Utilization			86.9%										ICU Level of Service	E
Analysis Period (min)			15											
c Critical Lane Group														

Queues
7: Arterial A2 & Mayfield Road

Future Background (2043) -Optimized
PM Peak Hour

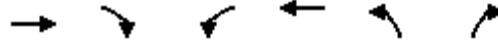

Lane Group	EBT	EBR	WBL	WBT	NBL	NBR
Lane Configurations	↑↑↑	↑	↓	↑↑↑	↓↓↓	↓
Traffic Volume (vph)	1129	215	215	1163	426	238
Future Volume (vph)	1129	215	215	1163	426	238
Lane Group Flow (vph)	1164	222	222	1199	471	213
Turn Type	NA	Perm	pm+pt	NA	Prot	Perm
Protected Phases	2		1	6	4	
Permitted Phases		2	6			4
Detector Phase	2	2	1	6	4	4
Switch Phase						
Minimum Initial (s)	12.0	12.0	5.0	12.0	8.0	8.0
Minimum Split (s)	30.3	30.3	9.5	30.3	30.0	30.0
Total Split (s)	55.0	55.0	10.0	65.0	55.0	55.0
Total Split (%)	45.8%	45.8%	8.3%	54.2%	45.8%	45.8%
Yellow Time (s)	4.6	4.6	3.0	4.6	4.2	4.2
All-Red Time (s)	2.7	2.7	0.0	2.7	2.8	2.8
Lost Time Adjust (s)	0.0	0.0	0.0	0.0	0.0	0.0
Total Lost Time (s)	7.3	7.3	3.0	7.3	7.0	7.0
Lead/Lag	Lag	Lag	Lead			
Lead-Lag Optimize?	Yes	Yes	Yes			
Recall Mode	C-Max	C-Max	None	C-Max	None	None
v/c Ratio	0.47	0.25	0.53	0.37	0.75	0.55
Control Delay	6.4	0.9	16.3	10.1	52.3	17.8
Queue Delay	0.0	0.0	0.0	0.0	0.0	0.0
Total Delay	6.4	0.9	16.3	10.1	52.3	17.8
Queue Length 50th (m)	15.5	0.0	19.0	38.4	56.4	12.9
Queue Length 95th (m)	12.3	m0.1	48.6	78.4	70.2	37.9
Internal Link Dist (m)	117.8			619.0	876.4	
Turn Bay Length (m)		60.0	100.0			
Base Capacity (vph)	2484	893	419	3241	1304	637
Starvation Cap Reductn	0	0	0	0	0	0
Spillback Cap Reductn	0	0	0	0	0	0
Storage Cap Reductn	0	0	0	0	0	0
Reduced v/c Ratio	0.47	0.25	0.53	0.37	0.36	0.33

Intersection Summary





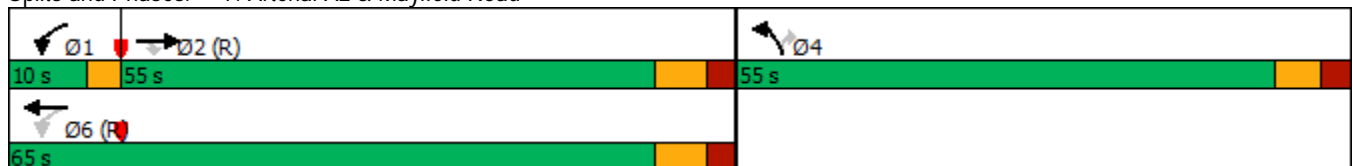

Cycle Length: 120
 Actuated Cycle Length: 120
 Offset: 96 (80%), Referenced to phase 2:EBT and 6:WBTL, Start of Green
 Natural Cycle: 70
 Control Type: Actuated-Coordinated
 m Volume for 95th percentile queue is metered by upstream signal.

Splits and Phases: 7: Arterial A2 & Mayfield Road



HCM Signalized Intersection Capacity Analysis
7: Arterial A2 & Mayfield Road

Future Background (2043) -Optimized
PM Peak Hour

						
Movement	EBT	EBR	WBL	WBT	NBL	NBR
Lane Configurations	↑↑↑	↑	↓	↑↑↑	↓↓↓	↑
Traffic Volume (vph)	1129	215	215	1163	426	238
Future Volume (vph)	1129	215	215	1163	426	238
Ideal Flow (vphpl)	1900	1900	1900	1900	1900	1900
Lane Width	3.5	3.0	3.0	3.5	3.0	3.0
Total Lost time (s)	7.3	7.3	3.0	7.3	7.0	7.0
Lane Util. Factor	0.91	1.00	1.00	0.91	0.97	0.91
Frt	1.00	0.85	1.00	1.00	0.99	0.85
Flt Protected	1.00	1.00	0.95	1.00	0.96	1.00
Satd. Flow (prot)	4749	1507	1652	4706	3251	1358
Flt Permitted	1.00	1.00	0.18	1.00	0.96	1.00
Satd. Flow (perm)	4749	1507	320	4706	3251	1358
Peak-hour factor, PHF	0.97	0.97	0.97	0.97	0.97	0.97
Adj. Flow (vph)	1164	222	222	1199	439	245
RTOR Reduction (vph)	0	105	0	0	6	127
Lane Group Flow (vph)	1164	117	222	1199	465	86
Heavy Vehicles (%)	8%	0%	2%	9%	0%	1%
Turn Type	NA	Perm	pm+pt	NA	Prot	Perm
Protected Phases	2		1	6	4	
Permitted Phases		2	6			4
Actuated Green, G (s)	62.8	62.8	82.7	82.7	23.0	23.0
Effective Green, g (s)	62.8	62.8	82.7	82.7	23.0	23.0
Actuated g/C Ratio	0.52	0.52	0.69	0.69	0.19	0.19
Clearance Time (s)	7.3	7.3	3.0	7.3	7.0	7.0
Vehicle Extension (s)	3.0	3.0	3.0	3.0	3.0	3.0
Lane Grp Cap (vph)	2485	788	408	3243	623	260
v/s Ratio Prot	0.25		c0.08	0.25	c0.14	
v/s Ratio Perm		0.08	c0.30			0.06
v/c Ratio	0.47	0.15	0.54	0.37	0.75	0.33
Uniform Delay, d1	18.1	14.8	8.4	7.8	45.7	41.9
Progression Factor	0.31	0.13	1.89	1.18	1.00	1.00
Incremental Delay, d2	0.6	0.4	1.4	0.3	4.8	0.8
Delay (s)	6.2	2.3	17.3	9.5	50.6	42.6
Level of Service	A	A	B	A	D	D
Approach Delay (s)	5.5			10.7	48.1	
Approach LOS	A			B	D	

Intersection Summary

HCM 2000 Control Delay	16.0	HCM 2000 Level of Service	B
HCM 2000 Volume to Capacity ratio	0.60		
Actuated Cycle Length (s)	120.0	Sum of lost time (s)	17.3
Intersection Capacity Utilization	63.6%	ICU Level of Service	B
Analysis Period (min)	15		

c Critical Lane Group

Queues
 9: Humber Station Road & Subject Lands Site Access #1

Future Background (2043) -Optimized
 PM Peak Hour

Lane Group	NBT	SBT	Ø8
Lane Configurations	↑	↑	
Traffic Volume (vph)	417	98	
Future Volume (vph)	417	98	
Lane Group Flow (vph)	417	98	
Turn Type	NA	NA	
Protected Phases	2	6	8
Permitted Phases			
Detector Phase	2	6	
Switch Phase			
Minimum Initial (s)	12.0	12.0	12.0
Minimum Split (s)	24.7	24.7	25.5
Total Split (s)	61.0	61.0	59.0
Total Split (%)	50.8%	50.8%	49%
Yellow Time (s)	4.2	4.2	4.0
All-Red Time (s)	2.5	2.5	3.5
Lost Time Adjust (s)	0.0	0.0	
Total Lost Time (s)	6.7	6.7	
Lead/Lag			
Lead-Lag Optimize?			
Recall Mode	C-Max	C-Max	None
v/c Ratio	0.23	0.05	
Control Delay	0.2	0.1	
Queue Delay	0.0	0.0	
Total Delay	0.2	0.1	
Queue Length 50th (m)	0.0	0.0	
Queue Length 95th (m)	m0.0	0.0	
Internal Link Dist (m)	1542.4	469.4	
Turn Bay Length (m)			
Base Capacity (vph)	1824	1842	
Starvation Cap Reductn	0	0	
Spillback Cap Reductn	0	0	
Storage Cap Reductn	0	0	
Reduced v/c Ratio	0.23	0.05	

Intersection Summary

Cycle Length: 120
 Actuated Cycle Length: 120
 Offset: 21 (18%), Referenced to phase 2:NBT and 6:SBTL, Start of Green
 Natural Cycle: 55
 Control Type: Actuated-Coordinated
 m Volume for 95th percentile queue is metered by upstream signal.

Splits and Phases: 9: Humber Station Road & Subject Lands Site Access #1

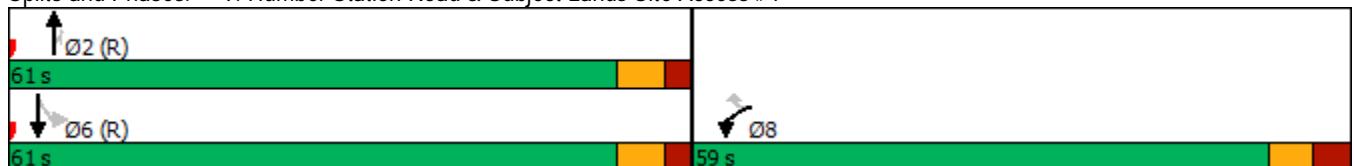

HCM Signalized Intersection Capacity Analysis
 9: Humber Station Road & Subject Lands Site Access #1

Future Background (2043) -Optimized
 PM Peak Hour



Movement	WBL	WBR	NBT	NBR	SBL	SBT
Lane Configurations	↶	↷	↕	↷	↶	↕
Traffic Volume (vph)	0	0	417	0	0	98
Future Volume (vph)	0	0	417	0	0	98
Ideal Flow (vphpl)	1900	1900	1900	1900	1900	1900
Lane Width	3.0	3.0	3.5	3.0	3.0	3.5
Total Lost time (s)			6.7			6.7
Lane Util. Factor			1.00			1.00
Frt			1.00			1.00
Flt Protected			1.00			1.00
Satd. Flow (prot)			1824			1842
Flt Permitted			1.00			1.00
Satd. Flow (perm)			1824			1842
Peak-hour factor, PHF	1.00	1.00	1.00	1.00	1.00	1.00
Adj. Flow (vph)	0	0	417	0	0	98
RTOR Reduction (vph)	0	0	0	0	0	0
Lane Group Flow (vph)	0	0	417	0	0	98
Heavy Vehicles (%)	0%	0%	3%	0%	0%	2%
Turn Type	Prot	Perm	NA	Perm	Perm	NA
Protected Phases	8		2			6
Permitted Phases		8		2	6	
Actuated Green, G (s)			120.0			120.0
Effective Green, g (s)			120.0			120.0
Actuated g/C Ratio			1.00			1.00
Clearance Time (s)			6.7			6.7
Vehicle Extension (s)			3.0			3.0
Lane Grp Cap (vph)			1824			1842
v/s Ratio Prot			c0.23			0.05
v/s Ratio Perm						
v/c Ratio			0.23			0.05
Uniform Delay, d1			0.0			0.0
Progression Factor			1.00			1.00
Incremental Delay, d2			0.2			0.1
Delay (s)			0.2			0.1
Level of Service			A			A
Approach Delay (s)	0.0		0.2			0.1
Approach LOS	A		A			A

Intersection Summary

HCM 2000 Control Delay	0.2	HCM 2000 Level of Service	A
HCM 2000 Volume to Capacity ratio	0.26		
Actuated Cycle Length (s)	120.0	Sum of lost time (s)	14.2
Intersection Capacity Utilization	27.5%	ICU Level of Service	A
Analysis Period (min)	15		

c Critical Lane Group

Queues
24: Mayfield Road & Triangle Lands

Future Background (2043) -Optimized
PM Peak Hour



Lane Group	EBL	EBT	WBT	SBL	SBR
Lane Configurations	↗	↑↑↑	↑↑↑↔	↖	↗
Traffic Volume (vph)	85	1282	1185	75	167
Future Volume (vph)	85	1282	1185	75	167
Lane Group Flow (vph)	85	1282	1242	75	167
Turn Type	Perm	NA	NA	Prot	Perm
Protected Phases		2	6	4	
Permitted Phases	2				4
Detector Phase	2	2	6	4	4
Switch Phase					
Minimum Initial (s)	12.0	12.0	12.0	5.0	5.0
Minimum Split (s)	37.0	37.0	37.0	33.0	33.0
Total Split (s)	87.0	87.0	87.0	33.0	33.0
Total Split (%)	72.5%	72.5%	72.5%	27.5%	27.5%
Yellow Time (s)	4.6	4.6	4.6	3.0	3.0
All-Red Time (s)	2.4	2.4	2.4	0.0	0.0
Lost Time Adjust (s)	0.0	0.0	0.0	0.0	0.0
Total Lost Time (s)	7.0	7.0	7.0	3.0	3.0
Lead/Lag					
Lead-Lag Optimize?					
Recall Mode	C-Max	C-Max	C-Max	None	None
v/c Ratio	0.32	0.31	0.31	0.48	0.72
Control Delay	4.5	0.5	3.4	59.4	38.0
Queue Delay	0.0	0.0	0.0	0.0	0.0
Total Delay	4.5	0.5	3.4	59.4	38.0
Queue Length 50th (m)	0.4	2.0	20.8	18.0	15.3
Queue Length 95th (m)	6.0	3.4	38.4	31.7	37.4
Internal Link Dist (m)		619.0	290.4	250.9	
Turn Bay Length (m)	30.0			30.0	
Base Capacity (vph)	267	4157	4066	366	407
Starvation Cap Reductn	0	0	0	0	0
Spillback Cap Reductn	0	0	0	0	0
Storage Cap Reductn	0	0	0	0	0
Reduced v/c Ratio	0.32	0.31	0.31	0.20	0.41

Intersection Summary

Cycle Length: 120
 Actuated Cycle Length: 120
 Offset: 0 (0%), Referenced to phase 2:EBTL and 6:WBT, Start of Green
 Natural Cycle: 70
 Control Type: Actuated-Coordinated

Splits and Phases: 24: Mayfield Road & Triangle Lands



HCM Signalized Intersection Capacity Analysis
 24: Mayfield Road & Triangle Lands

Future Background (2043) -Optimized
 PM Peak Hour















Movement	EBL	EBT	WBT	WBR	SBL	SBR
Lane Configurations	↖	↑↑↑	↑↑↑		↖	↗
Traffic Volume (vph)	85	1282	1185	57	75	167
Future Volume (vph)	85	1282	1185	57	75	167
Ideal Flow (vphpl)	1900	1900	1900	1900	1900	1900
Lane Width	3.0	3.5	3.5	3.0	3.0	3.0
Total Lost time (s)	7.0	7.0	7.0		3.0	3.0
Lane Util. Factor	1.00	0.91	0.91		1.00	1.00
Frt	1.00	1.00	0.99		1.00	0.85
Flt Protected	0.95	1.00	1.00		0.95	1.00
Satd. Flow (prot)	1478	5129	5014		1465	1322
Flt Permitted	0.21	1.00	1.00		0.95	1.00
Satd. Flow (perm)	329	5129	5014		1465	1322
Peak-hour factor, PHF	1.00	1.00	1.00	1.00	1.00	1.00
Adj. Flow (vph)	85	1282	1185	57	75	167
RTOR Reduction (vph)	0	0	2	0	0	92
Lane Group Flow (vph)	85	1282	1240	0	75	75
Heavy Vehicles (%)	14%	0%	1%	14%	15%	14%
Turn Type	Perm	NA	NA		Prot	Perm
Protected Phases		2	6		4	
Permitted Phases	2					4
Actuated Green, G (s)	97.3	97.3	97.3		12.7	12.7
Effective Green, g (s)	97.3	97.3	97.3		12.7	12.7
Actuated g/C Ratio	0.81	0.81	0.81		0.11	0.11
Clearance Time (s)	7.0	7.0	7.0		3.0	3.0
Vehicle Extension (s)	3.0	3.0	3.0		3.0	3.0
Lane Grp Cap (vph)	266	4158	4065		155	139
v/s Ratio Prot		0.25	0.25		0.05	
v/s Ratio Perm	c0.26					c0.06
v/c Ratio	0.32	0.31	0.30		0.48	0.54
Uniform Delay, d1	2.9	2.9	2.9		50.6	50.9
Progression Factor	0.37	0.10	1.00		1.00	1.00
Incremental Delay, d2	2.9	0.2	0.2		2.4	4.0
Delay (s)	3.9	0.5	3.0		52.9	54.9
Level of Service	A	A	A		D	D
Approach Delay (s)		0.7	3.0		54.3	
Approach LOS		A	A		D	

Intersection Summary				
HCM 2000 Control Delay		6.3	HCM 2000 Level of Service	A
HCM 2000 Volume to Capacity ratio		0.34		
Actuated Cycle Length (s)		120.0	Sum of lost time (s)	10.0
Intersection Capacity Utilization		53.3%	ICU Level of Service	A
Analysis Period (min)		15		

c Critical Lane Group

HCM Unsignalized Intersection Capacity Analysis
 26: Humber Station Road & Subject Lands Site Access #3

Future Background (2043) -Optimized
 PM Peak Hour

						
Movement	WBL	WBR	NBT	NBR	SBL	SBT
Lane Configurations						
Traffic Volume (veh/h)	0	0	417	0	0	98
Future Volume (Veh/h)	0	0	417	0	0	98
Sign Control	Stop		Free		Free	
Grade	0%		0%		0%	
Peak Hour Factor	1.00	1.00	1.00	1.00	1.00	1.00
Hourly flow rate (vph)	0	0	417	0	0	98
Pedestrians						
Lane Width (m)						
Walking Speed (m/s)						
Percent Blockage						
Right turn flare (veh)						
Median type	None			None		
Median storage (veh)						
Upstream signal (m)						
pX, platoon unblocked						
vC, conflicting volume	515	417			417	
vC1, stage 1 conf vol						
vC2, stage 2 conf vol						
vCu, unblocked vol	515	417			417	
tC, single (s)	6.4	6.2			4.1	
tC, 2 stage (s)						
tF (s)	3.5	3.3			2.2	
p0 queue free %	100	100			100	
cM capacity (veh/h)	523	640			1153	
Direction, Lane #	WB 1	WB 2	NB 1	NB 2	SB 1	SB 2
Volume Total	0	0	417	0	0	98
Volume Left	0	0	0	0	0	0
Volume Right	0	0	0	0	0	0
cSH	1700	1700	1700	1700	1700	1700
Volume to Capacity	0.00	0.00	0.25	0.00	0.00	0.06
Queue Length 95th (m)	0.0	0.0	0.0	0.0	0.0	0.0
Control Delay (s)	0.0	0.0	0.0	0.0	0.0	0.0
Lane LOS	A	A				
Approach Delay (s)	0.0		0.0		0.0	
Approach LOS	A					
Intersection Summary						
Average Delay			0.0			
Intersection Capacity Utilization			25.3%	ICU Level of Service	A	
Analysis Period (min)			15			

Queues
 27: Subject Lands Site Access #4 & Healey Road

Future Background (2043) -Optimized
 PM Peak Hour

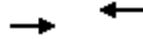

Lane Group	EBT	WBT	Ø2
Lane Configurations	↗	↖	
Traffic Volume (vph)	591	1164	
Future Volume (vph)	591	1164	
Lane Group Flow (vph)	591	1164	
Turn Type	NA	NA	
Protected Phases	4	8	2
Permitted Phases			
Detector Phase	4	8	
Switch Phase			
Minimum Initial (s)	5.0	5.0	5.0
Minimum Split (s)	22.5	22.5	22.5
Total Split (s)	97.0	97.0	23.0
Total Split (%)	80.8%	80.8%	19%
Yellow Time (s)	3.5	3.5	3.5
All-Red Time (s)	1.0	1.0	1.0
Lost Time Adjust (s)	0.0	0.0	
Total Lost Time (s)	4.5	4.5	
Lead/Lag			
Lead-Lag Optimize?			
Recall Mode	C-Max	C-Max	None
v/c Ratio	0.32	0.62	
Control Delay	0.4	1.8	
Queue Delay	0.0	0.0	
Total Delay	0.4	1.8	
Queue Length 50th (m)	0.0	0.7	
Queue Length 95th (m)	0.0	m7.7	
Internal Link Dist (m)	505.1	823.7	
Turn Bay Length (m)			
Base Capacity (vph)	1860	1879	
Starvation Cap Reductn	0	0	
Spillback Cap Reductn	0	0	
Storage Cap Reductn	0	0	
Reduced v/c Ratio	0.32	0.62	

Intersection Summary

Cycle Length: 120
 Actuated Cycle Length: 120
 Offset: 23 (19%), Referenced to phase 4:EBT and 8:WBTL, Start of Green
 Natural Cycle: 80
 Control Type: Actuated-Coordinated
 m Volume for 95th percentile queue is metered by upstream signal.

Splits and Phases: 27: Subject Lands Site Access #4 & Healey Road

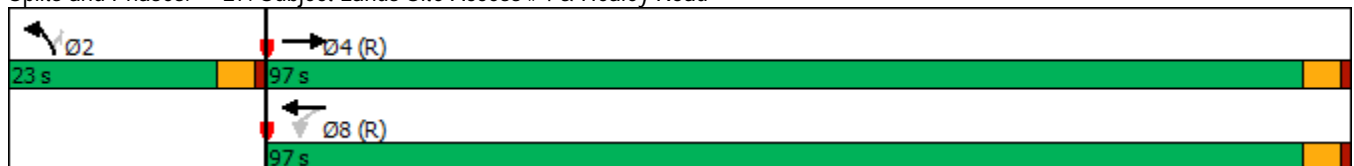

HCM Signalized Intersection Capacity Analysis
 27: Subject Lands Site Access #4 & Healey Road

Future Background (2043) -Optimized
 PM Peak Hour



Movement	EBT	EBR	WBL	WBT	NBL	NBR
Lane Configurations	↻		↻	↻	↻	↻
Traffic Volume (vph)	591	0	0	1164	0	0
Future Volume (vph)	591	0	0	1164	0	0
Ideal Flow (vphpl)	1900	1900	1900	1900	1900	1900
Lane Width	3.5	3.0	3.0	3.5	3.0	3.0
Total Lost time (s)	4.5			4.5		
Lane Util. Factor	1.00			1.00		
Frt	1.00			1.00		
Flt Protected	1.00			1.00		
Satd. Flow (prot)	1860			1879		
Flt Permitted	1.00			1.00		
Satd. Flow (perm)	1860			1879		
Peak-hour factor, PHF	1.00	1.00	1.00	1.00	1.00	1.00
Adj. Flow (vph)	591	0	0	1164	0	0
RTOR Reduction (vph)	0	0	0	0	0	0
Lane Group Flow (vph)	591	0	0	1164	0	0
Heavy Vehicles (%)	1%	0%	0%	0%	0%	0%
Turn Type	NA		Perm	NA	Prot	Perm
Protected Phases	4			8	2	
Permitted Phases			8			2
Actuated Green, G (s)	120.0			120.0		
Effective Green, g (s)	120.0			120.0		
Actuated g/C Ratio	1.00			1.00		
Clearance Time (s)	4.5			4.5		
Vehicle Extension (s)	3.0			3.0		
Lane Grp Cap (vph)	1860			1879		
v/s Ratio Prot	0.32			0.62		
v/s Ratio Perm						
v/c Ratio	0.32			0.62		
Uniform Delay, d1	0.0			0.0		
Progression Factor	1.00			1.00		
Incremental Delay, d2	0.4			0.4		
Delay (s)	0.4			0.4		
Level of Service	A			A		
Approach Delay (s)	0.4			0.4	0.0	
Approach LOS	A			A	A	
Intersection Summary						
HCM 2000 Control Delay			0.4		HCM 2000 Level of Service	A
HCM 2000 Volume to Capacity ratio			0.67			
Actuated Cycle Length (s)			120.0		Sum of lost time (s)	9.0
Intersection Capacity Utilization			65.0%		ICU Level of Service	C
Analysis Period (min)			15			

c Critical Lane Group

HCM Unsignalized Intersection Capacity Analysis
 28: Humber Station Road & Subject Lands Site Access #2

Future Background (2043) -Optimized
 PM Peak Hour



Movement	WBL	WBR	NBT	NBR	SBL	SBT
Lane Configurations						
Traffic Volume (veh/h)	0	0	417	0	0	98
Future Volume (Veh/h)	0	0	417	0	0	98
Sign Control	Stop		Free		Free	
Grade	0%		0%		0%	
Peak Hour Factor	1.00	1.00	1.00	1.00	1.00	1.00
Hourly flow rate (vph)	0	0	417	0	0	98
Pedestrians						
Lane Width (m)						
Walking Speed (m/s)						
Percent Blockage						
Right turn flare (veh)						
Median type			None		None	
Median storage veh						
Upstream signal (m)						
pX, platoon unblocked						
vC, conflicting volume	515	417			417	
vC1, stage 1 conf vol						
vC2, stage 2 conf vol						
vCu, unblocked vol	515	417			417	
tC, single (s)	6.4	6.2			4.1	
tC, 2 stage (s)						
tF (s)	3.5	3.3			2.2	
p0 queue free %	100	100			100	
cM capacity (veh/h)	523	640			1153	
Direction, Lane #	WB 1	WB 2	NB 1	NB 2	SB 1	SB 2
Volume Total	0	0	417	0	0	98
Volume Left	0	0	0	0	0	0
Volume Right	0	0	0	0	0	0
cSH	1700	1700	1700	1700	1700	1700
Volume to Capacity	0.00	0.00	0.25	0.00	0.00	0.06
Queue Length 95th (m)	0.0	0.0	0.0	0.0	0.0	0.0
Control Delay (s)	0.0	0.0	0.0	0.0	0.0	0.0
Lane LOS	A	A				
Approach Delay (s)	0.0		0.0		0.0	
Approach LOS	A					
Intersection Summary						
Average Delay			0.0			
Intersection Capacity Utilization			25.3%		ICU Level of Service	A
Analysis Period (min)			15			

HCM Unsignalized Intersection Capacity Analysis
 29: Mayfield Road & Subject Lands Site Access #5

Future Background (2043) -Optimized
 PM Peak Hour

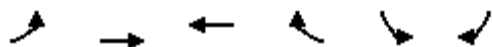

Movement	EBL	EBT	WBT	WBR	SBL	SBR				
Lane Configurations	↖	↑↑↑	↑↑↑↔		↘	↘				
Traffic Volume (veh/h)	0	1344	1589	0	0	0				
Future Volume (Veh/h)	0	1344	1589	0	0	0				
Sign Control	Free		Free	Stop						
Grade	0%		0%	0%						
Peak Hour Factor	1.00	1.00	1.00	1.00	1.00	1.00				
Hourly flow rate (vph)	0	1344	1589	0	0	0				
Pedestrians										
Lane Width (m)										
Walking Speed (m/s)										
Percent Blockage										
Right turn flare (veh)										
Median type	TWLTL		TWLTL							
Median storage veh	2		2							
Upstream signal (m)	270		142							
pX, platoon unblocked	0.90				0.90	0.90				
vC, conflicting volume	1589				2037	530				
vC1, stage 1 conf vol					1589					
vC2, stage 2 conf vol					448					
vCu, unblocked vol	1272				1018	97				
tC, single (s)	4.1				6.8	6.9				
tC, 2 stage (s)					5.8					
tF (s)	2.2				3.5	3.3				
p0 queue free %	100				100	100				
cM capacity (veh/h)	499				203	853				
Direction, Lane #	EB 1	EB 2	EB 3	EB 4	WB 1	WB 2	WB 3	SB 1	SB 2	
Volume Total	0	448	448	448	636	636	318	0	0	
Volume Left	0	0	0	0	0	0	0	0	0	
Volume Right	0	0	0	0	0	0	0	0	0	
cSH	1700	1700	1700	1700	1700	1700	1700	1700	1700	
Volume to Capacity	0.00	0.26	0.26	0.26	0.37	0.37	0.19	0.00	0.00	
Queue Length 95th (m)	0.0	0.0	0.0	0.0	0.0	0.0	0.0	0.0	0.0	
Control Delay (s)	0.0	0.0	0.0	0.0	0.0	0.0	0.0	0.0	0.0	
Lane LOS								A	A	
Approach Delay (s)	0.0				0.0			0.0		
Approach LOS								A		
Intersection Summary										
Average Delay			0.0							
Intersection Capacity Utilization			34.0%	ICU Level of Service					A	
Analysis Period (min)			15							



APPENDIX J

Future Total (2028, 2033, 2043) Intersection Capacity Analysis

Queues
1: Coleraine Drive & Healey Road

Future Total (2028) - Optimized
AM Peak Hour



Lane Group	EBL	EBT	WBL	WBT	NBL	NBT	SBL	SBT
Lane Configurations	↖	↗	↖	↗	↖	↕	↖	↕
Traffic Volume (vph)	155	347	49	146	35	130	64	324
Future Volume (vph)	155	347	49	146	35	130	64	324
Lane Group Flow (vph)	167	644	53	181	38	169	69	579
Turn Type	Perm	NA	Perm	NA	Perm	NA	Perm	NA
Protected Phases		8		4		6		2
Permitted Phases	8		4		6		2	
Detector Phase	8	8	4	4	6	6	2	2
Switch Phase								
Minimum Initial (s)	8.0	8.0	8.0	8.0	8.0	8.0	8.0	8.0
Minimum Split (s)	32.8	32.8	32.8	32.8	36.7	36.7	36.7	36.7
Total Split (s)	33.0	33.0	33.0	33.0	37.0	37.0	37.0	37.0
Total Split (%)	47.1%	47.1%	47.1%	47.1%	52.9%	52.9%	52.9%	52.9%
Yellow Time (s)	4.0	4.0	4.0	4.0	4.6	4.6	4.6	4.6
All-Red Time (s)	2.8	2.8	2.8	2.8	2.1	2.1	2.1	2.1
Lost Time Adjust (s)	0.0	0.0	0.0	0.0	0.0	0.0	0.0	0.0
Total Lost Time (s)	6.8	6.8	6.8	6.8	6.7	6.7	6.7	6.7
Lead/Lag								
Lead-Lag Optimize?								
Recall Mode	None	None	None	None	C-Max	C-Max	C-Max	C-Max
v/c Ratio	0.42	0.96	0.63	0.29	0.12	0.15	0.18	0.40
Control Delay	20.3	47.5	56.1	15.9	13.3	10.3	13.8	8.7
Queue Delay	0.0	0.0	0.0	0.0	0.0	0.0	0.0	0.0
Total Delay	20.3	47.5	56.1	15.9	13.3	10.3	13.8	8.7
Queue Length 50th (m)	16.6	77.1	5.8	15.7	3.0	5.8	5.6	15.5
Queue Length 95th (m)	32.8	#144.5	#24.1	30.1	8.7	11.4	13.5	26.8
Internal Link Dist (m)		1349.5		424.0		1711.9		1121.0
Turn Bay Length (m)	55.0		50.0		80.0		155.0	
Base Capacity (vph)	406	683	85	625	313	1155	391	1457
Starvation Cap Reductn	0	0	0	0	0	0	0	0
Spillback Cap Reductn	0	0	0	0	0	0	0	0
Storage Cap Reductn	0	0	0	0	0	0	0	0
Reduced v/c Ratio	0.41	0.94	0.62	0.29	0.12	0.15	0.18	0.40

Intersection Summary





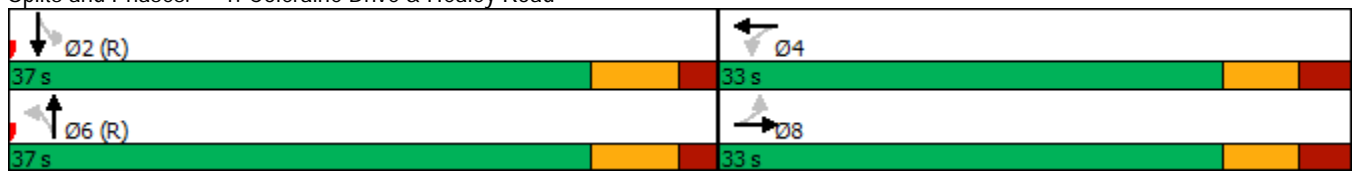

















Cycle Length: 70
 Actuated Cycle Length: 70
 Offset: 6 (9%), Referenced to phase 2:SBTL and 6:NBTL, Start of Green
 Natural Cycle: 75
 Control Type: Actuated-Coordinated
 # 95th percentile volume exceeds capacity, queue may be longer.
 Queue shown is maximum after two cycles.

Splits and Phases: 1: Coleraine Drive & Healey Road



HCM Signalized Intersection Capacity Analysis
1: Coleraine Drive & Healey Road

Future Total (2028) - Optimized
AM Peak Hour

												
Movement	EBL	EBT	EBR	WBL	WBT	WBR	NBL	NBT	NBR	SBL	SBT	SBR
Lane Configurations												
Traffic Volume (vph)	155	347	252	49	146	22	35	130	27	64	324	215
Future Volume (vph)	155	347	252	49	146	22	35	130	27	64	324	215
Ideal Flow (vphpl)	1900	1900	1900	1900	1900	1900	1900	1900	1900	1900	1900	1900
Lane Width	3.0	3.5	3.0	3.0	3.5	3.0	3.0	3.5	3.0	3.0	3.5	3.0
Total Lost time (s)	6.8	6.8		6.8	6.8		6.7	6.7		6.7	6.7	
Lane Util. Factor	1.00	1.00		1.00	1.00		1.00	0.95		1.00	0.95	
Fr _t	1.00	0.94		1.00	0.98		1.00	0.97		1.00	0.94	
Fl _t Protected	0.95	1.00		0.95	1.00		0.95	1.00		0.95	1.00	
Satd. Flow (prot)	1604	1726		1404	1650		1636	2597		1316	3029	
Fl _t Permitted	0.64	1.00		0.16	1.00		0.42	1.00		0.65	1.00	
Satd. Flow (perm)	1086	1726		229	1650		715	2597		894	3029	
Peak-hour factor, PHF	0.93	0.93	0.93	0.93	0.93	0.93	0.93	0.93	0.93	0.93	0.93	0.93
Adj. Flow (vph)	167	373	271	53	157	24	38	140	29	69	348	231
RTOR Reduction (vph)	0	38	0	0	8	0	0	16	0	0	130	0
Lane Group Flow (vph)	167	606	0	53	173	0	38	153	0	69	449	0
Heavy Vehicles (%)	5%	2%	2%	20%	3%	68%	3%	37%	19%	28%	16%	3%
Turn Type	Perm	NA		Perm	NA		Perm	NA		Perm	NA	
Protected Phases		8			4			6			2	
Permitted Phases	8			4			6			2		
Actuated Green, G (s)	25.8	25.8		25.8	25.8		30.7	30.7		30.7	30.7	
Effective Green, g (s)	25.8	25.8		25.8	25.8		30.7	30.7		30.7	30.7	
Actuated g/C Ratio	0.37	0.37		0.37	0.37		0.44	0.44		0.44	0.44	
Clearance Time (s)	6.8	6.8		6.8	6.8		6.7	6.7		6.7	6.7	
Vehicle Extension (s)	3.0	3.0		3.0	3.0		3.0	3.0		3.0	3.0	
Lane Grp Cap (vph)	400	636		84	608		313	1138		392	1328	
v/s Ratio Prot		c0.35			0.10			0.06			c0.15	
v/s Ratio Perm	0.15			0.23			0.05			0.08		
v/c Ratio	0.42	0.95		0.63	0.28		0.12	0.13		0.18	0.34	
Uniform Delay, d ₁	16.5	21.5		18.2	15.6		11.7	11.7		12.0	13.0	
Progression Factor	1.00	1.00		1.00	1.00		1.00	1.00		1.00	1.00	
Incremental Delay, d ₂	0.7	24.5		14.4	0.3		0.8	0.2		1.0	0.7	
Delay (s)	17.2	46.0		32.6	15.8		12.4	12.0		12.9	13.6	
Level of Service	B	D		C	B		B	B		B	B	
Approach Delay (s)		40.1			19.6			12.1			13.6	
Approach LOS		D			B			B			B	
Intersection Summary												
HCM 2000 Control Delay			25.5				HCM 2000 Level of Service				C	
HCM 2000 Volume to Capacity ratio			0.62									
Actuated Cycle Length (s)			70.0			Sum of lost time (s)				13.5		
Intersection Capacity Utilization			85.3%			ICU Level of Service				E		
Analysis Period (min)			15									
c Critical Lane Group												

Queues
2: Humber Station Road & Healey Road

Future Total (2028) - Optimized
AM Peak Hour

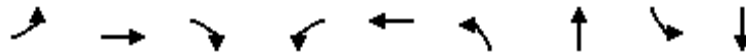

Lane Group	EBL	EBT	EBR	WBL	WBT	NBL	NBT	SBL	SBT
Lane Configurations	↖	↑	↗	↖	↗	↖	↗	↖	↗
Traffic Volume (vph)	4	618	83	149	265	44	18	79	187
Future Volume (vph)	4	618	83	149	265	44	18	79	187
Lane Group Flow (vph)	4	665	89	160	289	47	87	85	205
Turn Type	Perm	NA	Perm	pm+pt	NA	Perm	NA	Perm	NA
Protected Phases		4		3	8		2		6
Permitted Phases	4		4	8		2		6	
Detector Phase	4	4	4	3	8	2	2	6	6
Switch Phase									
Minimum Initial (s)	8.0	8.0	8.0	5.0	8.0	8.0	8.0	5.0	5.0
Minimum Split (s)	24.8	24.8	24.8	9.5	24.8	24.7	24.7	24.8	24.8
Total Split (s)	65.0	65.0	65.0	25.0	90.0	30.0	30.0	30.0	30.0
Total Split (%)	54.2%	54.2%	54.2%	20.8%	75.0%	25.0%	25.0%	25.0%	25.0%
Yellow Time (s)	4.0	4.0	4.0	3.0	4.0	4.6	4.6	4.6	4.6
All-Red Time (s)	2.8	2.8	2.8	0.0	2.8	2.1	2.1	2.1	2.1
Lost Time Adjust (s)	0.0	0.0	0.0	0.0	0.0	0.0	0.0	0.0	0.0
Total Lost Time (s)	6.8	6.8	6.8	3.0	6.8	6.7	6.7	6.7	6.7
Lead/Lag	Lag	Lag	Lag	Lead					
Lead-Lag Optimize?	Yes	Yes	Yes	Yes					
Recall Mode	None	None	None	None	None	C-Max	C-Max	C-Max	C-Max
v/c Ratio	0.01	0.86	0.14	0.63	0.29	0.15	0.15	0.20	0.32
Control Delay	17.0	43.5	7.5	24.4	14.8	31.0	10.0	32.5	32.9
Queue Delay	0.0	0.0	0.0	0.0	0.0	0.0	0.0	0.0	0.0
Total Delay	17.0	43.5	7.5	24.4	14.8	31.0	10.0	32.5	32.9
Queue Length 50th (m)	0.6	144.6	4.0	17.2	36.0	7.8	1.8	15.1	37.8
Queue Length 95th (m)	2.5	176.4	12.6	29.4	44.5	m20.1	16.6	31.3	65.2
Internal Link Dist (m)		465.5			1349.5		1464.0		452.2
Turn Bay Length (m)	30.0		30.0	60.0		30.0		30.0	
Base Capacity (vph)	402	895	728	376	1271	312	575	431	644
Starvation Cap Reductn	0	0	0	0	0	0	0	0	0
Spillback Cap Reductn	0	0	0	0	0	0	0	0	0
Storage Cap Reductn	0	0	0	0	0	0	0	0	0
Reduced v/c Ratio	0.01	0.74	0.12	0.43	0.23	0.15	0.15	0.20	0.32

Intersection Summary

Cycle Length: 120
 Actuated Cycle Length: 120
 Offset: 0 (0%), Referenced to phase 2:NBTL and 6:SBTL, Start of Green
 Natural Cycle: 70
 Control Type: Actuated-Coordinated
 m Volume for 95th percentile queue is metered by upstream signal.



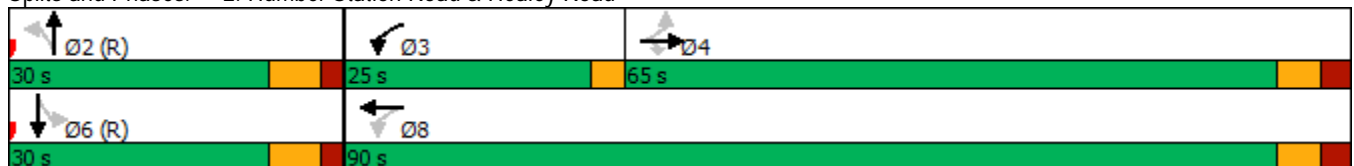

















Splits and Phases: 2: Humber Station Road & Healey Road



HCM Signalized Intersection Capacity Analysis

2: Humber Station Road & Healey Road

Future Total (2028) - Optimized
AM Peak Hour

												
Movement	EBL	EBT	EBR	WBL	WBT	WBR	NBL	NBT	NBR	SBL	SBT	SBR
Lane Configurations												
Traffic Volume (vph)	4	618	83	149	265	4	44	18	63	79	187	4
Future Volume (vph)	4	618	83	149	265	4	44	18	63	79	187	4
Ideal Flow (vphpl)	1900	1900	1900	1900	1900	1900	1900	1900	1900	1900	1900	1900
Lane Width	3.0	3.5	3.0	3.0	3.5	3.0	3.0	3.5	3.0	3.0	3.5	3.0
Total Lost time (s)	6.8	6.8	6.8	3.0	6.8		6.7	6.7		6.7	6.7	
Lane Util. Factor	1.00	1.00	1.00	1.00	1.00		1.00	1.00		1.00	1.00	
Flt	1.00	1.00	0.85	1.00	1.00		1.00	0.88		1.00	1.00	
Flt Protected	0.95	1.00	1.00	0.95	1.00		0.95	1.00		0.95	1.00	
Satd. Flow (prot)	1348	1842	1436	1604	1833		1478	1527		1685	1855	
Flt Permitted	0.58	1.00	1.00	0.12	1.00		0.58	1.00		0.70	1.00	
Satd. Flow (perm)	827	1842	1436	211	1833		900	1527		1242	1855	
Peak-hour factor, PHF	0.93	0.93	0.93	0.93	0.93	0.93	0.93	0.93	0.93	0.93	0.93	0.93
Adj. Flow (vph)	4	665	89	160	285	4	47	19	68	85	201	4
RTOR Reduction (vph)	0	0	35	0	0	0	0	44	0	0	1	0
Lane Group Flow (vph)	4	665	54	160	289	0	47	43	0	85	204	0
Heavy Vehicles (%)	25%	2%	5%	5%	2%	25%	14%	0%	11%	0%	1%	0%
Turn Type	Perm	NA	Perm	pm+pt	NA		Perm	NA		Perm	NA	
Protected Phases		4		3	8			2			6	
Permitted Phases	4		4	8			2			6		
Actuated Green, G (s)	50.2	50.2	50.2	64.8	64.8		41.7	41.7		41.7	41.7	
Effective Green, g (s)	50.2	50.2	50.2	64.8	64.8		41.7	41.7		41.7	41.7	
Actuated g/C Ratio	0.42	0.42	0.42	0.54	0.54		0.35	0.35		0.35	0.35	
Clearance Time (s)	6.8	6.8	6.8	3.0	6.8		6.7	6.7		6.7	6.7	
Vehicle Extension (s)	3.0	3.0	3.0	3.0	3.0		3.0	3.0		3.0	3.0	
Lane Grp Cap (vph)	345	770	600	248	989		312	530		431	644	
v/s Ratio Prot		c0.36		c0.06	0.16			0.03			c0.11	
v/s Ratio Perm	0.00		0.04	0.29			0.05			0.07		
v/c Ratio	0.01	0.86	0.09	0.65	0.29		0.15	0.08		0.20	0.32	
Uniform Delay, d1	20.4	31.8	21.1	21.5	15.1		27.0	26.3		27.4	28.7	
Progression Factor	1.00	1.00	1.00	1.00	1.00		0.94	0.85		1.00	1.00	
Incremental Delay, d2	0.0	9.9	0.1	5.7	0.2		1.0	0.3		1.0	1.3	
Delay (s)	20.4	41.7	21.2	27.2	15.2		26.3	22.7		28.4	30.0	
Level of Service	C	D	C	C	B		C	C		C	C	
Approach Delay (s)		39.2			19.5			24.0			29.5	
Approach LOS		D			B			C			C	

Intersection Summary		
HCM 2000 Control Delay	30.8	HCM 2000 Level of Service C
HCM 2000 Volume to Capacity ratio	0.62	
Actuated Cycle Length (s)	120.0	Sum of lost time (s) 16.5
Intersection Capacity Utilization	77.7%	ICU Level of Service D
Analysis Period (min)	15	

c Critical Lane Group

Queues

Future Total (2028) - Optimized

3: Clarkway Drive/Humber Station Road & Mayfield Road

AM Peak Hour

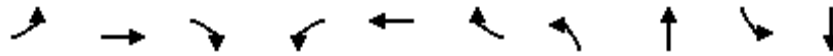

Lane Group	EBL	EBT	EBR	WBL	WBT	WBR	NBL	NBT	SBL	SBT
Lane Configurations	↔	↑↑↑	↔	↔	↑↑	↔	↔	↔	↔	↔
Traffic Volume (vph)	141	754	28	102	567	63	11	120	34	288
Future Volume (vph)	141	754	28	102	567	63	11	120	34	288
Lane Group Flow (vph)	147	785	29	106	591	66	11	331	35	351
Turn Type	Perm	NA	Perm	Perm	NA	Perm	Perm	NA	Perm	NA
Protected Phases		2			6			4		8
Permitted Phases	2		2	6		6	4		8	
Detector Phase	2	2	2	6	6	6	4	4	8	8
Switch Phase										
Minimum Initial (s)	12.0	12.0	12.0	12.0	12.0	12.0	8.0	8.0	8.0	8.0
Minimum Split (s)	27.3	27.3	27.3	27.5	27.5	27.5	26.0	26.0	27.5	27.5
Total Split (s)	70.0	70.0	70.0	70.0	70.0	70.0	50.0	50.0	50.0	50.0
Total Split (%)	58.3%	58.3%	58.3%	58.3%	58.3%	58.3%	41.7%	41.7%	41.7%	41.7%
Yellow Time (s)	4.6	4.6	4.6	4.6	4.6	4.6	4.2	4.2	4.2	4.2
All-Red Time (s)	2.7	2.7	2.7	2.7	2.7	2.7	2.8	2.8	2.8	2.8
Lost Time Adjust (s)	0.0	0.0	0.0	0.0	0.0	0.0	0.0	0.0	0.0	0.0
Total Lost Time (s)	7.3	7.3	7.3	7.3	7.3	7.3	7.0	7.0	7.0	7.0
Lead/Lag										
Lead-Lag Optimize?										
Recall Mode	C-Max	C-Max	C-Max	C-Max	C-Max	C-Max	None	None	None	None
v/c Ratio	0.34	0.28	0.04	0.30	0.31	0.07	0.11	0.72	0.29	0.81
Control Delay	14.6	10.8	3.0	14.5	11.4	2.9	34.0	39.7	46.1	62.6
Queue Delay	0.0	0.0	0.0	0.0	0.0	0.0	0.0	0.0	0.0	0.0
Total Delay	14.6	10.8	3.0	14.5	11.4	2.9	34.0	39.7	46.1	62.6
Queue Length 50th (m)	15.9	29.5	0.0	11.1	32.7	0.0	2.1	58.3	8.0	86.9
Queue Length 95th (m)	36.0	44.9	3.6	27.4	52.5	6.4	6.8	83.8	18.3	115.3
Internal Link Dist (m)		1635.6			198.0			1951.8		1542.4
Turn Bay Length (m)	150.0		105.0	150.0		115.0	75.0		105.0	
Base Capacity (vph)	434	2826	777	354	1917	908	147	634	175	627
Starvation Cap Reductn	0	0	0	0	0	0	0	0	0	0
Spillback Cap Reductn	0	0	0	0	0	0	0	0	0	0
Storage Cap Reductn	0	0	0	0	0	0	0	0	0	0
Reduced v/c Ratio	0.34	0.28	0.04	0.30	0.31	0.07	0.07	0.52	0.20	0.56

Intersection Summary

Cycle Length: 120
 Actuated Cycle Length: 120
 Offset: 0 (0%), Referenced to phase 2:EBTL and 6:WBTL, Start of Green
 Natural Cycle: 60
 Control Type: Actuated-Coordinated

Splits and Phases: 3: Clarkway Drive/Humber Station Road & Mayfield Road

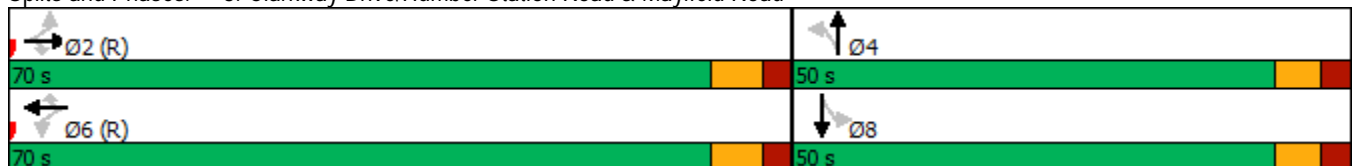

HCM Signalized Intersection Capacity Analysis
 3: Clarkway Drive/Humber Station Road & Mayfield Road

Future Total (2028) - Optimized
 AM Peak Hour



Movement	EBL	EBT	EBR	WBL	WBT	WBR	NBL	NBT	NBR	SBL	SBT	SBR
Lane Configurations	↖	↑↑↑	↗	↖	↑↑	↗	↖	↗		↖	↗	
Traffic Volume (vph)	141	754	28	102	567	63	11	120	198	34	288	49
Future Volume (vph)	141	754	28	102	567	63	11	120	198	34	288	49
Ideal Flow (vphpl)	1900	1900	1900	1900	1900	1900	1900	1900	1900	1900	1900	1900
Lane Width	3.0	3.5	3.0	3.0	3.5	3.0	3.0	3.5	3.0	3.0	3.5	3.0
Total Lost time (s)	7.3	7.3	7.3	7.3	7.3	7.3	7.0	7.0		7.0	7.0	
Lane Util. Factor	1.00	0.91	1.00	1.00	0.95	1.00	1.00	1.00		1.00	1.00	
Frt	1.00	1.00	0.85	1.00	1.00	0.85	1.00	0.91		1.00	0.98	
Flt Protected	0.95	1.00	1.00	0.95	1.00	1.00	0.95	1.00		0.95	1.00	
Satd. Flow (prot)	1560	4460	1206	1574	3025	1396	1428	1632		1504	1752	
Flt Permitted	0.42	1.00	1.00	0.34	1.00	1.00	0.27	1.00		0.31	1.00	
Satd. Flow (perm)	687	4460	1206	560	3025	1396	413	1632		489	1752	
Peak-hour factor, PHF	0.96	0.96	0.96	0.96	0.96	0.96	0.96	0.96	0.96	0.96	0.96	0.96
Adj. Flow (vph)	147	785	29	106	591	66	11	125	206	35	300	51
RTOR Reduction (vph)	0	0	11	0	0	24	0	58	0	0	0	0
Lane Group Flow (vph)	147	785	18	106	591	42	11	273	0	35	351	0
Heavy Vehicles (%)	8%	15%	25%	7%	18%	8%	18%	5%	4%	12%	3%	16%
Turn Type	Perm	NA	Perm	Perm	NA	Perm	Perm	NA		Perm	NA	
Protected Phases		2			6			4			8	
Permitted Phases	2		2	6		6	4			8		
Actuated Green, G (s)	76.0	76.0	76.0	76.0	76.0	76.0	29.7	29.7		29.7	29.7	
Effective Green, g (s)	76.0	76.0	76.0	76.0	76.0	76.0	29.7	29.7		29.7	29.7	
Actuated g/C Ratio	0.63	0.63	0.63	0.63	0.63	0.63	0.25	0.25		0.25	0.25	
Clearance Time (s)	7.3	7.3	7.3	7.3	7.3	7.3	7.0	7.0		7.0	7.0	
Vehicle Extension (s)	3.0	3.0	3.0	3.0	3.0	3.0	3.0	3.0		3.0	3.0	
Lane Grp Cap (vph)	435	2824	763	354	1915	884	102	403		121	433	
v/s Ratio Prot		0.18			0.20			0.17			c0.20	
v/s Ratio Perm	c0.21		0.02	0.19		0.03	0.03			0.07		
v/c Ratio	0.34	0.28	0.02	0.30	0.31	0.05	0.11	0.68		0.29	0.81	
Uniform Delay, d1	10.3	9.8	8.2	10.0	10.0	8.3	34.9	40.8		36.6	42.5	
Progression Factor	1.00	1.00	1.00	1.00	1.00	1.00	1.00	1.00		1.16	1.14	
Incremental Delay, d2	2.1	0.2	0.1	2.2	0.4	0.1	0.5	4.5		1.3	10.8	
Delay (s)	12.4	10.0	8.2	12.1	10.4	8.4	35.4	45.3		43.7	59.3	
Level of Service	B	B	A	B	B	A	D	D		D	E	
Approach Delay (s)		10.3			10.5			45.0			57.9	
Approach LOS		B			B			D			E	

Intersection Summary		
HCM 2000 Control Delay	22.7	HCM 2000 Level of Service C
HCM 2000 Volume to Capacity ratio	0.47	
Actuated Cycle Length (s)	120.0	Sum of lost time (s) 14.3
Intersection Capacity Utilization	71.9%	ICU Level of Service C
Analysis Period (min)	15	

c Critical Lane Group

Queues
4: Coleraine Drive & Mayfield Road

Future Total (2028) - Optimized
AM Peak Hour

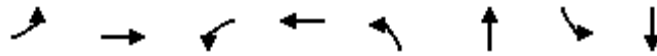

Lane Group	EBL	EBT	WBL	WBT	NBL	NBT	SBL	SBT
Lane Configurations	↖	↕	↖	↕	↖	↕	↖	↕
Traffic Volume (vph)	286	502	44	545	20	133	67	339
Future Volume (vph)	286	502	44	545	20	133	67	339
Lane Group Flow (vph)	325	627	50	662	23	161	76	626
Turn Type	pm+pt	NA	Perm	NA	Perm	NA	pm+pt	NA
Protected Phases	5	2		6		4	3	8
Permitted Phases	2		6		4		8	
Detector Phase	5	2	6	6	4	4	3	8
Switch Phase								
Minimum Initial (s)	5.0	12.0	12.0	12.0	12.0	12.0	5.0	12.0
Minimum Split (s)	8.0	37.0	37.0	37.0	37.0	37.0	8.0	37.0
Total Split (s)	15.0	80.0	65.0	65.0	32.0	32.0	18.0	50.0
Total Split (%)	11.5%	61.5%	50.0%	50.0%	24.6%	24.6%	13.8%	38.5%
Yellow Time (s)	3.0	4.6	4.6	4.6	4.2	4.2	3.0	4.2
All-Red Time (s)	0.0	2.4	2.4	2.4	2.8	2.8	0.0	2.8
Lost Time Adjust (s)	0.0	0.0	0.0	0.0	0.0	0.0	0.0	0.0
Total Lost Time (s)	3.0	7.0	7.0	7.0	7.0	7.0	3.0	7.0
Lead/Lag	Lead		Lag	Lag	Lag	Lag	Lead	
Lead-Lag Optimize?	Yes		Yes	Yes	Yes	Yes	Yes	
Recall Mode	None	C-Max	C-Max	C-Max	None	None	None	None
v/c Ratio	0.62	0.30	0.13	0.38	0.37	0.38	0.30	0.82
Control Delay	13.2	9.1	19.5	19.8	71.1	54.4	40.9	49.3
Queue Delay	0.0	0.0	0.0	0.0	0.0	0.0	0.0	0.0
Total Delay	13.2	9.1	19.5	19.8	71.1	54.4	40.9	49.3
Queue Length 50th (m)	28.4	31.6	6.5	52.4	5.9	21.1	16.6	71.3
Queue Length 95th (m)	50.6	48.5	16.6	78.4	15.2	31.2	27.6	84.2
Internal Link Dist (m)		290.4		1003.7		192.7		576.8
Turn Bay Length (m)	100.0		85.0		105.0		145.0	
Base Capacity (vph)	524	2094	391	1732	101	679	272	1127
Starvation Cap Reductn	0	0	0	0	0	0	0	0
Spillback Cap Reductn	0	0	0	0	0	0	0	0
Storage Cap Reductn	0	0	0	0	0	0	0	0
Reduced v/c Ratio	0.62	0.30	0.13	0.38	0.23	0.24	0.28	0.56

Intersection Summary

Cycle Length: 130
 Actuated Cycle Length: 130
 Offset: 92 (71%), Referenced to phase 2:EBTL and 6:WBTL, Start of Green
 Natural Cycle: 90
 Control Type: Actuated-Coordinated





















Splits and Phases: 4: Coleraine Drive & Mayfield Road



HCM Signalized Intersection Capacity Analysis

4: Coleraine Drive & Mayfield Road

Future Total (2028) - Optimized
AM Peak Hour

												
Movement	EBL	EBT	EBR	WBL	WBT	WBR	NBL	NBT	NBR	SBL	SBT	SBR
Lane Configurations												
Traffic Volume (vph)	286	502	50	44	545	38	20	133	9	67	339	212
Future Volume (vph)	286	502	50	44	545	38	20	133	9	67	339	212
Ideal Flow (vphpl)	1900	1900	1900	1900	1900	1900	1900	1900	1900	1900	1900	1900
Lane Width	3.0	3.5	3.0	3.0	3.5	3.0	3.0	3.5	3.0	3.0	3.5	3.0
Total Lost time (s)	3.0	7.0		7.0	7.0		7.0	7.0		3.0	7.0	
Lane Util. Factor	1.00	0.95		1.00	0.95		1.00	0.95		1.00	0.95	
Fr't	1.00	0.99		1.00	0.99		1.00	0.99		1.00	0.94	
Fl't Protected	0.95	1.00		0.95	1.00		0.95	1.00		0.95	1.00	
Satd. Flow (prot)	1560	3069		1685	3238		1532	3513		1452	3180	
Fl't Permitted	0.34	1.00		0.41	1.00		0.33	1.00		0.54	1.00	
Satd. Flow (perm)	559	3069		734	3238		527	3513		832	3180	
Peak-hour factor, PHF	0.88	0.88	0.88	0.88	0.88	0.88	0.88	0.88	0.88	0.88	0.88	0.88
Adj. Flow (vph)	325	570	57	50	619	43	23	151	10	76	385	241
RTOR Reduction (vph)	0	4	0	0	3	0	0	4	0	0	89	0
Lane Group Flow (vph)	325	623	0	50	659	0	23	157	0	76	537	0
Heavy Vehicles (%)	8%	16%	2%	0%	8%	26%	10%	0%	11%	16%	0%	15%
Turn Type	pm+pt	NA		Perm	NA		Perm	NA		pm+pt	NA	
Protected Phases	5	2			6			4		3	8	
Permitted Phases	2			6			4			8		
Actuated Green, G (s)	88.0	88.0		68.8	68.8		15.4	15.4		28.0	28.0	
Effective Green, g (s)	88.0	88.0		68.8	68.8		15.4	15.4		28.0	28.0	
Actuated g/C Ratio	0.68	0.68		0.53	0.53		0.12	0.12		0.22	0.22	
Clearance Time (s)	3.0	7.0		7.0	7.0		7.0	7.0		3.0	7.0	
Vehicle Extension (s)	3.0	3.0		3.0	3.0		3.0	3.0		3.0	3.0	
Lane Grp Cap (vph)	503	2077		388	1713		62	416		224	684	
v/s Ratio Prot	c0.08	0.20			0.20			0.04		0.02	c0.17	
v/s Ratio Perm	c0.36			0.07			0.04			0.05		
v/c Ratio	0.65	0.30		0.13	0.38		0.37	0.38		0.34	0.79	
Uniform Delay, d1	9.4	8.5		15.5	18.1		52.8	52.9		42.3	48.2	
Progression Factor	1.00	1.00		1.00	1.00		1.00	1.00		1.00	1.00	
Incremental Delay, d2	2.9	0.4		0.7	0.7		3.7	0.6		0.9	5.9	
Delay (s)	12.3	8.9		16.1	18.7		56.6	53.4		43.2	54.1	
Level of Service	B	A		B	B		E	D		D	D	
Approach Delay (s)		10.0			18.6			53.8			52.9	
Approach LOS		B			B			D			D	
Intersection Summary												
HCM 2000 Control Delay			27.4				HCM 2000 Level of Service				C	
HCM 2000 Volume to Capacity ratio			0.71									
Actuated Cycle Length (s)			130.0			Sum of lost time (s)				20.0		
Intersection Capacity Utilization			79.1%			ICU Level of Service				D		
Analysis Period (min)			15									

c Critical Lane Group

Queues

Future Total (2028) - Optimized

5: Coleraine Drive & Private Access/George Bolton Parkway

AM Peak Hour



Lane Group	EBL	EBT	WBL	WBT	NBL	NBT	SBL	SBT	SBR
Lane Configurations	↶	↷	↶	↷	↶	↷	↶	↷	↷
Traffic Volume (vph)	4	12	63	23	30	339	94	476	11
Future Volume (vph)	4	12	63	23	30	339	94	476	11
Lane Group Flow (vph)	5	29	73	191	35	506	109	553	13
Turn Type	Perm	NA	Perm	NA	Perm	NA	Perm	NA	Perm
Protected Phases		8		4		6		2	
Permitted Phases	8		4		6		2		2
Detector Phase	8	8	4	4	6	6	2	2	2
Switch Phase									
Minimum Initial (s)	8.0	8.0	12.0	12.0	12.0	12.0	12.0	12.0	12.0
Minimum Split (s)	32.5	32.5	32.5	32.5	34.2	34.2	33.7	33.7	33.7
Total Split (s)	45.0	45.0	45.0	45.0	55.0	55.0	55.0	55.0	55.0
Total Split (%)	45.0%	45.0%	45.0%	45.0%	55.0%	55.0%	55.0%	55.0%	55.0%
Yellow Time (s)	4.0	4.0	4.0	4.0	4.2	4.2	4.2	4.2	4.2
All-Red Time (s)	3.5	3.5	3.5	3.5	2.5	2.5	2.5	2.5	2.5
Lost Time Adjust (s)	0.0	0.0	0.0	0.0	0.0	0.0	0.0	0.0	0.0
Total Lost Time (s)	7.5	7.5	7.5	7.5	6.7	6.7	6.7	6.7	6.7
Lead/Lag									
Lead-Lag Optimize?									
Recall Mode	None	None	None	None	C-Max	C-Max	C-Max	C-Max	C-Max
v/c Ratio	0.04	0.15	0.52	0.56	0.08	0.24	0.20	0.25	0.01
Control Delay	35.2	24.0	52.1	15.3	5.6	5.0	6.4	5.6	0.0
Queue Delay	0.0	0.0	0.0	0.0	0.0	0.0	0.0	0.0	0.0
Total Delay	35.2	24.0	52.1	15.3	5.6	5.0	6.4	5.6	0.0
Queue Length 50th (m)	0.9	2.6	14.2	5.0	1.7	13.1	5.9	16.4	0.0
Queue Length 95th (m)	3.9	9.7	25.9	21.4	5.7	23.3	14.8	28.2	0.0
Internal Link Dist (m)		152.4		468.8		784.9		1711.9	
Turn Bay Length (m)	70.0		105.0		75.0		100.0		100.0
Base Capacity (vph)	345	486	369	633	458	2127	551	2216	1001
Starvation Cap Reductn	0	0	0	0	0	0	0	0	0
Spillback Cap Reductn	0	0	0	0	0	0	0	0	0
Storage Cap Reductn	0	0	0	0	0	0	0	0	0
Reduced v/c Ratio	0.01	0.06	0.20	0.30	0.08	0.24	0.20	0.25	0.01

Intersection Summary





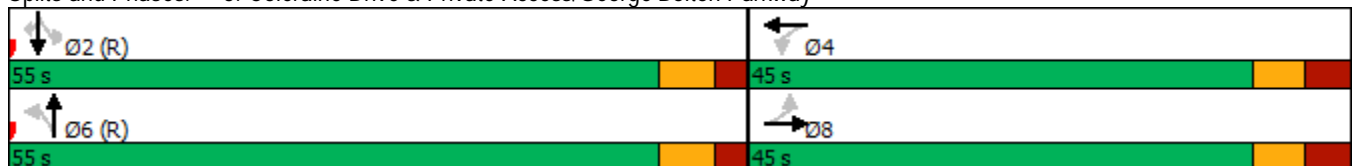

















Cycle Length: 100
 Actuated Cycle Length: 100
 Offset: 0 (0%), Referenced to phase 2:SBTL and 6:NBTL, Start of Green
 Natural Cycle: 70
 Control Type: Actuated-Coordinated

Splits and Phases: 5: Coleraine Drive & Private Access/George Bolton Parkway



HCM Signalized Intersection Capacity Analysis
 5: Coleraine Drive & Private Access/George Bolton Parkway

Future Total (2028) - Optimized
 AM Peak Hour

												
Movement	EBL	EBT	EBR	WBL	WBT	WBR	NBL	NBT	NBR	SBL	SBT	SBR
Lane Configurations												
Traffic Volume (vph)	4	12	13	63	23	141	30	339	96	94	476	11
Future Volume (vph)	4	12	13	63	23	141	30	339	96	94	476	11
Ideal Flow (vphpl)	1900	1900	1900	1900	1900	1900	1900	1900	1900	1900	1900	1900
Lane Width	3.0	3.5	3.0	3.0	3.5	3.0	3.0	3.5	3.0	3.0	3.5	3.0
Total Lost time (s)	7.5	7.5		7.5	7.5		6.7	6.7		6.7	6.7	6.7
Lane Util. Factor	1.00	1.00		1.00	1.00		1.00	0.95		1.00	0.95	1.00
Fr _t	1.00	0.92		1.00	0.87		1.00	0.97		1.00	1.00	0.85
Fl _t Protected	0.95	1.00		0.95	1.00		0.95	1.00		0.95	1.00	1.00
Satd. Flow (prot)	1685	1271		1267	1417		1370	2958		1574	3104	1383
Fl _t Permitted	0.52	1.00		0.74	1.00		0.45	1.00		0.47	1.00	1.00
Satd. Flow (perm)	921	1271		984	1417		642	2958		772	3104	1383
Peak-hour factor, PHF	0.86	0.86	0.86	0.86	0.86	0.86	0.86	0.86	0.86	0.86	0.86	0.86
Adj. Flow (vph)	5	14	15	73	27	164	35	394	112	109	553	13
RTOR Reduction (vph)	0	13	0	0	140	0	0	15	0	0	0	4
Lane Group Flow (vph)	5	16	0	73	51	0	35	491	0	109	553	9
Heavy Vehicles (%)	0%	42%	31%	33%	43%	11%	23%	16%	19%	7%	15%	9%
Turn Type	Perm	NA		Perm	NA		Perm	NA		Perm	NA	Perm
Protected Phases		8			4			6			2	
Permitted Phases	8			4			6			2		2
Actuated Green, G (s)	14.4	14.4		14.4	14.4		71.4	71.4		71.4	71.4	71.4
Effective Green, g (s)	14.4	14.4		14.4	14.4		71.4	71.4		71.4	71.4	71.4
Actuated g/C Ratio	0.14	0.14		0.14	0.14		0.71	0.71		0.71	0.71	0.71
Clearance Time (s)	7.5	7.5		7.5	7.5		6.7	6.7		6.7	6.7	6.7
Vehicle Extension (s)	3.0	3.0		3.0	3.0		3.0	3.0		3.0	3.0	3.0
Lane Grp Cap (vph)	132	183		141	204		458	2112		551	2216	987
v/s Ratio Prot		0.01			0.04			0.17			c0.18	
v/s Ratio Perm	0.01			c0.07			0.05			0.14		0.01
v/c Ratio	0.04	0.09		0.52	0.25		0.08	0.23		0.20	0.25	0.01
Uniform Delay, d ₁	36.8	37.1		39.6	38.0		4.3	4.9		4.8	5.0	4.1
Progression Factor	1.00	1.00		1.00	1.00		1.00	1.00		1.00	1.00	1.00
Incremental Delay, d ₂	0.1	0.2		3.2	0.6		0.3	0.3		0.8	0.3	0.0
Delay (s)	37.0	37.3		42.8	38.6		4.7	5.2		5.6	5.2	4.1
Level of Service	D	D		D	D		A	A		A	A	A
Approach Delay (s)		37.3			39.8			5.1			5.3	
Approach LOS		D			D			A			A	

Intersection Summary		
HCM 2000 Control Delay	12.0	HCM 2000 Level of Service
HCM 2000 Volume to Capacity ratio	0.29	B
Actuated Cycle Length (s)	100.0	Sum of lost time (s)
Intersection Capacity Utilization	50.7%	14.2
Analysis Period (min)	15	ICU Level of Service
		A

c Critical Lane Group

Queues
6: Highway 50 & George Bolton Parkway/Private Access

Future Total (2028) - Optimized
AM Peak Hour



Lane Group	EBL	EBT	WBT	NBL	NBT	SBL	SBT	SBR
Lane Configurations								
Traffic Volume (vph)	81	0	0	153	886	3	1144	138
Future Volume (vph)	81	0	0	153	886	3	1144	138
Lane Group Flow (vph)	84	114	1	159	923	3	1192	144
Turn Type	Perm	NA	NA	pm+pt	NA	Perm	NA	Perm
Protected Phases		8	4	1	6		2	
Permitted Phases	8			6		2		2
Detector Phase	8	8	4	1	6	2	2	2
Switch Phase								
Minimum Initial (s)	8.0	8.0	8.0	5.0	12.0	12.0	12.0	12.0
Minimum Split (s)	32.6	32.6	32.6	8.0	27.3	27.3	27.3	27.3
Total Split (s)	35.0	35.0	35.0	10.0	85.0	75.0	75.0	75.0
Total Split (%)	29.2%	29.2%	29.2%	8.3%	70.8%	62.5%	62.5%	62.5%
Yellow Time (s)	4.0	4.0	4.0	3.0	4.0	4.0	4.0	4.0
All-Red Time (s)	2.6	2.6	2.6	0.0	2.3	2.3	2.3	2.3
Lost Time Adjust (s)	0.0	0.0	0.0	0.0	0.0	0.0	0.0	0.0
Total Lost Time (s)	6.6	6.6	6.6	3.0	6.3	6.3	6.3	6.3
Lead/Lag				Lead		Lag	Lag	Lag
Lead-Lag Optimize?				Yes		Yes	Yes	Yes
Recall Mode	None	None	None	None	C-Max	C-Max	C-Max	C-Max
v/c Ratio	0.61	0.41	0.00	0.52	0.35	0.01	0.54	0.14
Control Delay	67.7	6.5	0.0	9.4	4.9	9.0	12.2	2.2
Queue Delay	0.0	0.0	0.0	0.0	0.0	0.0	0.0	0.0
Total Delay	67.7	6.5	0.0	9.4	4.9	9.0	12.2	2.2
Queue Length 50th (m)	20.1	0.0	0.0	6.9	30.6	0.2	71.5	0.5
Queue Length 95th (m)	35.8	5.8	0.0	15.7	49.4	1.7	116.1	9.2
Internal Link Dist (m)		846.5	43.0		1045.6		1307.8	
Turn Bay Length (m)	85.0			40.0		135.0		60.0
Base Capacity (vph)	286	401	515	304	2644	368	2222	1019
Starvation Cap Reductn	0	0	0	0	0	0	0	0
Spillback Cap Reductn	0	0	0	0	0	0	0	0
Storage Cap Reductn	0	0	0	0	0	0	0	0
Reduced v/c Ratio	0.29	0.28	0.00	0.52	0.35	0.01	0.54	0.14

Intersection Summary





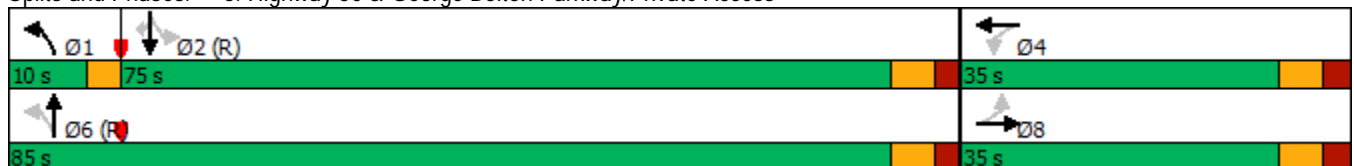















Cycle Length: 120
 Actuated Cycle Length: 120
 Offset: 113 (94%), Referenced to phase 2:SBTL and 6:NBTL, Start of Green
 Natural Cycle: 80
 Control Type: Actuated-Coordinated

Splits and Phases: 6: Highway 50 & George Bolton Parkway/Private Access



HCM Signalized Intersection Capacity Analysis
6: Highway 50 & George Bolton Parkway/Private Access

Future Total (2028) - Optimized
AM Peak Hour

												
Movement	EBL	EBT	EBR	WBL	WBT	WBR	NBL	NBT	NBR	SBL	SBT	SBR
Lane Configurations												
Traffic Volume (vph)	81	0	109	0	0	1	153	886	0	3	1144	138
Future Volume (vph)	81	0	109	0	0	1	153	886	0	3	1144	138
Ideal Flow (vphpl)	1900	1900	1900	1900	1900	1900	1900	1900	1900	1900	1900	1900
Lane Width	3.0	3.5	3.0	3.0	3.5	3.0	3.0	3.5	3.0	3.0	3.5	3.0
Total Lost time (s)	6.6	6.6			6.6		3.0	6.3		6.3	6.3	6.3
Lane Util. Factor	1.00	1.00			1.00		1.00	0.95		1.00	0.95	1.00
Frt	1.00	0.85			0.86		1.00	1.00		1.00	1.00	0.85
Flt Protected	0.95	1.00			1.00		0.95	1.00		0.95	1.00	1.00
Satd. Flow (prot)	1518	1174			1625		1370	3400		1685	3305	1449
Flt Permitted	0.76	1.00			1.00		0.19	1.00		0.31	1.00	1.00
Satd. Flow (perm)	1210	1174			1625		269	3400		549	3305	1449
Peak-hour factor, PHF	0.96	0.96	0.96	0.96	0.96	0.96	0.96	0.96	0.96	0.96	0.96	0.96
Adj. Flow (vph)	84	0	114	0	0	1	159	923	0	3	1192	144
RTOR Reduction (vph)	0	101	0	0	1	0	0	0	0	0	0	45
Lane Group Flow (vph)	84	13	0	0	0	0	159	923	0	3	1192	99
Heavy Vehicles (%)	11%	0%	36%	0%	0%	0%	23%	5%	0%	0%	8%	4%
Turn Type	Perm	NA			NA		pm+pt	NA		Perm	NA	Perm
Protected Phases		8			4		1	6			2	
Permitted Phases	8			4			6			2		2
Actuated Green, G (s)	13.8	13.8			13.8		93.3	93.3		80.7	80.7	80.7
Effective Green, g (s)	13.8	13.8			13.8		93.3	93.3		80.7	80.7	80.7
Actuated g/C Ratio	0.12	0.12			0.12		0.78	0.78		0.67	0.67	0.67
Clearance Time (s)	6.6	6.6			6.6		3.0	6.3		6.3	6.3	6.3
Vehicle Extension (s)	3.0	3.0			3.0		3.0	3.0		3.0	3.0	3.0
Lane Grp Cap (vph)	139	135			186		297	2643		369	2222	974
v/s Ratio Prot		0.01			0.00		c0.04	0.27			0.36	
v/s Ratio Perm	c0.07						c0.37			0.01		0.07
v/c Ratio	0.60	0.10			0.00		0.54	0.35		0.01	0.54	0.10
Uniform Delay, d1	50.5	47.5			47.0		5.8	4.1		6.5	10.1	6.9
Progression Factor	1.00	1.00			1.00		1.00	1.00		1.00	1.00	1.00
Incremental Delay, d2	7.2	0.3			0.0		1.9	0.4		0.0	0.9	0.2
Delay (s)	57.7	47.8			47.0		7.7	4.4		6.5	11.0	7.1
Level of Service	E	D			D		A	A		A	B	A
Approach Delay (s)		52.0			47.0			4.9			10.6	
Approach LOS		D			D			A			B	













Intersection Summary

HCM 2000 Control Delay	11.4	HCM 2000 Level of Service	B
HCM 2000 Volume to Capacity ratio	0.56		
Actuated Cycle Length (s)	120.0	Sum of lost time (s)	15.9
Intersection Capacity Utilization	65.3%	ICU Level of Service	C
Analysis Period (min)	15		

c Critical Lane Group

HCM Unsignalized Intersection Capacity Analysis
 9: Humber Station Road & Subject Lands Site Access 1

Future Total (2028) - Optimized
 AM Peak Hour

						
Movement	WBL	WBR	NBT	NBR	SBL	SBT
Lane Configurations						
Traffic Volume (veh/h)	81	50	81	243	136	290
Future Volume (Veh/h)	81	50	81	243	136	290
Sign Control	Stop		Free		Free	
Grade	0%		0%		0%	
Peak Hour Factor	1.00	1.00	1.00	1.00	1.00	1.00
Hourly flow rate (vph)	81	50	81	243	136	290
Pedestrians						
Lane Width (m)						
Walking Speed (m/s)						
Percent Blockage						
Right turn flare (veh)						
Median type	None			None		
Median storage veh						
Upstream signal (m)						
pX, platoon unblocked						
vC, conflicting volume	643	81			324	
vC1, stage 1 conf vol						
vC2, stage 2 conf vol						
vCu, unblocked vol	643	81			324	
tC, single (s)	6.6	6.4			4.2	
tC, 2 stage (s)						
tF (s)	3.7	3.5			2.3	
p0 queue free %	78	95			89	
cM capacity (veh/h)	364	931			1208	
Direction, Lane #	WB 1	WB 2	NB 1	NB 2	SB 1	SB 2
Volume Total	81	50	81	243	136	290
Volume Left	81	0	0	0	136	0
Volume Right	0	50	0	243	0	0
cSH	364	931	1700	1700	1208	1700
Volume to Capacity	0.22	0.05	0.05	0.14	0.11	0.17
Queue Length 95th (m)	6.7	1.4	0.0	0.0	3.0	0.0
Control Delay (s)	17.7	9.1	0.0	0.0	8.4	0.0
Lane LOS	C	A			A	
Approach Delay (s)	14.4		0.0		2.7	
Approach LOS	B					
Intersection Summary						
Average Delay			3.4			
Intersection Capacity Utilization			29.2%		ICU Level of Service	A
Analysis Period (min)			15			

HCM Unsignalized Intersection Capacity Analysis

24: Mayfield Road & Triangle Lands

Future Total (2028) - Optimized
AM Peak Hour

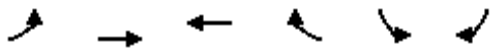

Movement	EBL	EBT	WBT	WBR	SBL	SBR	
Lane Configurations							
Traffic Volume (veh/h)	160	826	660	108	33	72	
Future Volume (Veh/h)	160	826	660	108	33	72	
Sign Control		Free	Free		Stop		
Grade		0%	0%		0%		
Peak Hour Factor	1.00	1.00	1.00	1.00	1.00	1.00	
Hourly flow rate (vph)	160	826	660	108	33	72	
Pedestrians							
Lane Width (m)							
Walking Speed (m/s)							
Percent Blockage							
Right turn flare (veh)							
Median type		None	None				
Median storage (veh)							
Upstream signal (m)			314				
pX, platoon unblocked	0.91				0.91	0.91	
vC, conflicting volume	768				1447	384	
vC1, stage 1 conf vol							
vC2, stage 2 conf vol							
vCu, unblocked vol	557				1301	137	
tC, single (s)	4.2				7.0	7.2	
tC, 2 stage (s)							
tF (s)	2.3				3.6	3.4	
p0 queue free %	82				69	91	
cM capacity (veh/h)	891				105	779	
Direction, Lane #	EB 1	EB 2	EB 3	WB 1	WB 2	SB 1	SB 2
Volume Total	160	413	413	440	328	33	72
Volume Left	160	0	0	0	0	33	0
Volume Right	0	0	0	0	108	0	72
cSH	891	1700	1700	1700	1700	105	779
Volume to Capacity	0.18	0.24	0.24	0.26	0.19	0.31	0.09
Queue Length 95th (m)	5.2	0.0	0.0	0.0	0.0	9.7	2.4
Control Delay (s)	9.9	0.0	0.0	0.0	0.0	54.2	10.1
Lane LOS	A					F	B
Approach Delay (s)	1.6			0.0		24.0	
Approach LOS						C	
Intersection Summary							
Average Delay			2.2				
Intersection Capacity Utilization			43.9%		ICU Level of Service		A
Analysis Period (min)			15				

Queues
1: Coleraine Drive & Healey Road

Future Total (2028) - Optimized
PM Peak Hour



Lane Group	EBL	EBT	WBL	WBT	NBL	NBT	SBL	SBT
Lane Configurations	↶	↷	↶	↷	↶	↷	↶	↷
Traffic Volume (vph)	159	183	56	323	301	350	47	188
Future Volume (vph)	159	183	56	323	301	350	47	188
Lane Group Flow (vph)	175	399	62	448	331	442	52	309
Turn Type	Perm	NA	Perm	NA	Perm	NA	Perm	NA
Protected Phases		8		4		6		2
Permitted Phases	8		4		6		2	
Detector Phase	8	8	4	4	6	6	2	2
Switch Phase								
Minimum Initial (s)	8.0	8.0	8.0	8.0	8.0	8.0	8.0	8.0
Minimum Split (s)	32.8	32.8	32.8	32.8	36.7	36.7	36.7	36.7
Total Split (s)	33.0	33.0	33.0	33.0	37.0	37.0	37.0	37.0
Total Split (%)	47.1%	47.1%	47.1%	47.1%	52.9%	52.9%	52.9%	52.9%
Yellow Time (s)	4.0	4.0	4.0	4.0	4.6	4.6	4.6	4.6
All-Red Time (s)	2.8	2.8	2.8	2.8	2.1	2.1	2.1	2.1
Lost Time Adjust (s)	0.0	0.0	0.0	0.0	0.0	0.0	0.0	0.0
Total Lost Time (s)	6.8	6.8	6.8	6.8	6.7	6.7	6.7	6.7
Lead/Lag								
Lead-Lag Optimize?								
Recall Mode	None	None	None	None	C-Max	C-Max	C-Max	C-Max
v/c Ratio	0.99	0.65	0.31	0.76	0.70	0.31	0.15	0.22
Control Delay	93.7	20.4	20.5	28.2	26.7	12.1	13.4	8.3
Queue Delay	0.0	0.0	0.0	0.0	0.0	0.0	0.0	0.0
Total Delay	93.7	20.4	20.5	28.2	26.7	12.1	13.4	8.3
Queue Length 50th (m)	21.9	33.6	5.8	47.7	37.3	18.8	4.2	8.7
Queue Length 95th (m)	#58.2	60.6	15.2	79.0	#81.2	29.2	11.1	16.3
Internal Link Dist (m)		1349.5		424.0		1711.9		1121.0
Turn Bay Length (m)	55.0		50.0		80.0		155.0	
Base Capacity (vph)	199	686	229	668	472	1431	352	1407
Starvation Cap Reductn	0	0	0	0	0	0	0	0
Spillback Cap Reductn	0	0	0	0	0	0	0	0
Storage Cap Reductn	0	0	0	0	0	0	0	0
Reduced v/c Ratio	0.88	0.58	0.27	0.67	0.70	0.31	0.15	0.22

Intersection Summary





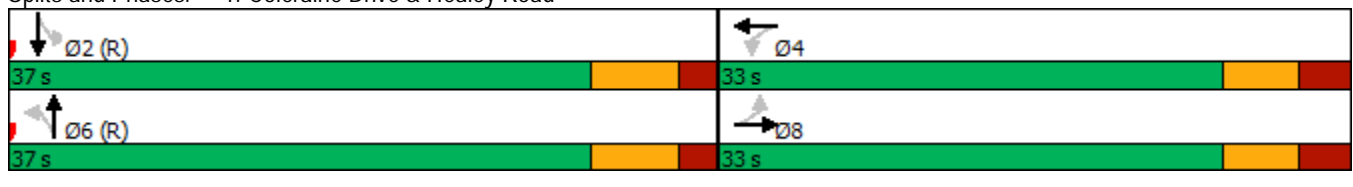

















Cycle Length: 70
 Actuated Cycle Length: 70
 Offset: 12 (17%), Referenced to phase 2:SBTL and 6:NBTL, Start of Green
 Natural Cycle: 70
 Control Type: Actuated-Coordinated
 # 95th percentile volume exceeds capacity, queue may be longer.
 Queue shown is maximum after two cycles.

Splits and Phases: 1: Coleraine Drive & Healey Road



HCM Signalized Intersection Capacity Analysis
1: Coleraine Drive & Healey Road

Future Total (2028) - Optimized
PM Peak Hour

												
Movement	EBL	EBT	EBR	WBL	WBT	WBR	NBL	NBT	NBR	SBL	SBT	SBR
Lane Configurations												
Traffic Volume (vph)	159	183	180	56	323	85	301	350	52	47	188	93
Future Volume (vph)	159	183	180	56	323	85	301	350	52	47	188	93
Ideal Flow (vphpl)	1900	1900	1900	1900	1900	1900	1900	1900	1900	1900	1900	1900
Lane Width	3.0	3.5	3.0	3.0	3.5	3.0	3.0	3.5	3.0	3.0	3.5	3.0
Total Lost time (s)	6.8	6.8		6.8	6.8		6.7	6.7		6.7	6.7	
Lane Util. Factor	1.00	1.00		1.00	1.00		1.00	0.95		1.00	0.95	
Flt	1.00	0.93		1.00	0.97		1.00	0.98		1.00	0.95	
Flt Protected	0.95	1.00		0.95	1.00		0.95	1.00		0.95	1.00	
Satd. Flow (prot)	1620	1697		1546	1748		1668	2970		1416	2842	
Flt Permitted	0.31	1.00		0.38	1.00		0.56	1.00		0.50	1.00	
Satd. Flow (perm)	534	1697		614	1748		990	2970		739	2842	
Peak-hour factor, PHF	0.91	0.91	0.91	0.91	0.91	0.91	0.91	0.91	0.91	0.91	0.91	0.91
Adj. Flow (vph)	175	201	198	62	355	93	331	385	57	52	207	102
RTOR Reduction (vph)	0	54	0	0	15	0	0	15	0	0	53	0
Lane Group Flow (vph)	175	345	0	62	433	0	331	427	0	52	256	0
Heavy Vehicles (%)	4%	1%	4%	9%	1%	16%	1%	18%	17%	19%	26%	6%
Turn Type	Perm	NA		Perm	NA		Perm	NA		Perm	NA	
Protected Phases		8			4			6			2	
Permitted Phases	8			4			6			2		
Actuated Green, G (s)	23.1	23.1		23.1	23.1		33.4	33.4		33.4	33.4	
Effective Green, g (s)	23.1	23.1		23.1	23.1		33.4	33.4		33.4	33.4	
Actuated g/C Ratio	0.33	0.33		0.33	0.33		0.48	0.48		0.48	0.48	
Clearance Time (s)	6.8	6.8		6.8	6.8		6.7	6.7		6.7	6.7	
Vehicle Extension (s)	3.0	3.0		3.0	3.0		3.0	3.0		3.0	3.0	
Lane Grp Cap (vph)	176	560		202	576		472	1417		352	1356	
v/s Ratio Prot		0.20			0.25			0.14			0.09	
v/s Ratio Perm	c0.33			0.10			c0.33			0.07		
v/c Ratio	0.99	0.62		0.31	0.75		0.70	0.30		0.15	0.19	
Uniform Delay, d1	23.4	19.7		17.5	20.9		14.4	11.2		10.3	10.5	
Progression Factor	1.00	1.00		1.00	1.00		1.00	1.00		1.00	1.00	
Incremental Delay, d2	65.8	2.0		0.9	5.5		8.4	0.5		0.9	0.3	
Delay (s)	89.2	21.7		18.3	26.4		22.8	11.7		11.2	10.8	
Level of Service	F	C		B	C		C	B		B	B	
Approach Delay (s)		42.3			25.4			16.5			10.9	
Approach LOS		D			C			B			B	
Intersection Summary												
HCM 2000 Control Delay			24.3				HCM 2000 Level of Service				C	
HCM 2000 Volume to Capacity ratio			0.82									
Actuated Cycle Length (s)			70.0				Sum of lost time (s)				13.5	
Intersection Capacity Utilization			78.3%				ICU Level of Service				D	
Analysis Period (min)			15									

c Critical Lane Group

Queues
2: Humber Station Road & Healey Road

Future Total (2028) - Optimized
PM Peak Hour

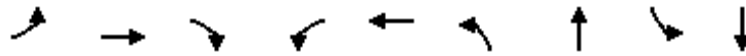

Lane Group	EBL	EBT	EBR	WBL	WBT	NBL	NBT	SBL	SBT
Lane Configurations	↶	↷	↶	↶	↷	↶	↷	↶	↷
Traffic Volume (vph)	21	308	37	69	627	116	206	25	53
Future Volume (vph)	21	308	37	69	627	116	206	25	53
Lane Group Flow (vph)	22	318	38	71	669	120	374	26	61
Turn Type	Perm	NA	Perm	pm+pt	NA	Perm	NA	Perm	NA
Protected Phases		4		3	8		2		6
Permitted Phases	4		4	8		2		6	
Detector Phase	4	4	4	3	8	2	2	6	6
Switch Phase									
Minimum Initial (s)	8.0	8.0	8.0	5.0	8.0	8.0	8.0	8.0	8.0
Minimum Split (s)	24.8	24.8	24.8	9.5	24.8	24.7	24.7	24.7	24.7
Total Split (s)	62.0	62.0	62.0	10.0	72.0	48.0	48.0	48.0	48.0
Total Split (%)	51.7%	51.7%	51.7%	8.3%	60.0%	40.0%	40.0%	40.0%	40.0%
Yellow Time (s)	4.0	4.0	4.0	3.0	4.0	4.6	4.6	4.6	4.6
All-Red Time (s)	2.8	2.8	2.8	0.0	2.8	2.1	2.1	2.1	2.1
Lost Time Adjust (s)	0.0	0.0	0.0	0.0	0.0	0.0	0.0	0.0	0.0
Total Lost Time (s)	6.8	6.8	6.8	3.0	6.8	6.7	6.7	6.7	6.7
Lead/Lag	Lag	Lag	Lag	Lead					
Lead-Lag Optimize?	Yes	Yes	Yes	Yes					
Recall Mode	None	None	None	None	None	C-Max	C-Max	C-Max	C-Max
v/c Ratio	0.18	0.46	0.07	0.20	0.82	0.23	0.48	0.08	0.08
Control Delay	26.7	30.2	2.2	16.7	38.0	17.5	17.0	23.9	21.0
Queue Delay	0.0	0.0	0.0	0.0	0.0	0.0	0.0	0.0	0.0
Total Delay	26.7	30.2	2.2	16.7	38.0	17.5	17.0	23.9	21.0
Queue Length 50th (m)	3.7	60.5	0.0	9.4	141.0	11.4	32.1	3.7	7.8
Queue Length 95th (m)	9.4	75.3	3.3	14.9	161.2	m24.0	74.0	11.3	19.2
Internal Link Dist (m)		465.5			1349.5		1464.0		452.2
Turn Bay Length (m)	30.0		30.0	60.0		30.0		30.0	
Base Capacity (vph)	155	847	630	359	1004	522	779	342	790
Starvation Cap Reductn	0	0	0	0	0	0	0	0	0
Spillback Cap Reductn	0	0	0	0	0	0	0	0	0
Storage Cap Reductn	0	0	0	0	0	0	0	0	0
Reduced v/c Ratio	0.14	0.38	0.06	0.20	0.67	0.23	0.48	0.08	0.08

Intersection Summary

Cycle Length: 120
 Actuated Cycle Length: 120
 Offset: 0 (0%), Referenced to phase 2:NBTL and 6:SBTL, Start of Green
 Natural Cycle: 60
 Control Type: Actuated-Coordinated
 m Volume for 95th percentile queue is metered by upstream signal.



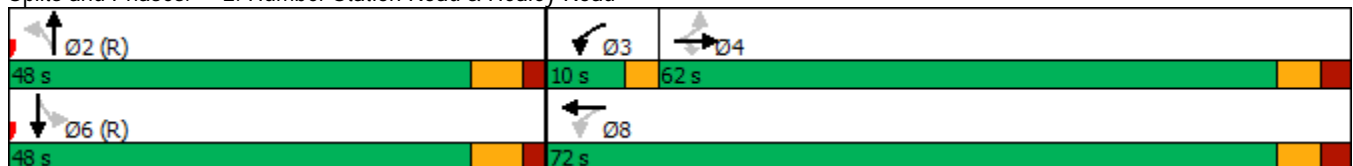

















Splits and Phases: 2: Humber Station Road & Healey Road



HCM Signalized Intersection Capacity Analysis

2: Humber Station Road & Healey Road

Future Total (2028) - Optimized
PM Peak Hour

												
Movement	EBL	EBT	EBR	WBL	WBT	WBR	NBL	NBT	NBR	SBL	SBT	SBR
Lane Configurations												
Traffic Volume (vph)	21	308	37	69	627	22	116	206	157	25	53	6
Future Volume (vph)	21	308	37	69	627	22	116	206	157	25	53	6
Ideal Flow (vphpl)	1900	1900	1900	1900	1900	1900	1900	1900	1900	1900	1900	1900
Lane Width	3.0	3.5	3.0	3.0	3.5	3.0	3.0	3.5	3.0	3.0	3.5	3.0
Total Lost time (s)	6.8	6.8	6.8	3.0	6.8		6.7	6.7		6.7	6.7	
Lane Util. Factor	1.00	1.00	1.00	1.00	1.00		1.00	1.00		1.00	1.00	
Flt	1.00	1.00	0.85	1.00	0.99		1.00	0.94		1.00	0.99	
Flt Protected	0.95	1.00	1.00	0.95	1.00		0.95	1.00		0.95	1.00	
Satd. Flow (prot)	1685	1842	1299	1491	1848		1546	1696		1685	1756	
Flt Permitted	0.19	1.00	1.00	0.42	1.00		0.72	1.00		0.43	1.00	
Satd. Flow (perm)	336	1842	1299	660	1848		1167	1696		762	1756	
Peak-hour factor, PHF	0.97	0.97	0.97	0.97	0.97	0.97	0.97	0.97	0.97	0.97	0.97	0.97
Adj. Flow (vph)	22	318	38	71	646	23	120	212	162	26	55	6
RTOR Reduction (vph)	0	0	24	0	1	0	0	19	0	0	3	0
Lane Group Flow (vph)	22	318	14	71	668	0	120	355	0	26	58	0
Heavy Vehicles (%)	0%	2%	16%	13%	1%	5%	9%	1%	7%	0%	6%	0%
Turn Type	Perm	NA	Perm	pm+pt	NA		Perm	NA		Perm	NA	
Protected Phases		4		3	8			2			6	
Permitted Phases	4		4	8			2			6		
Actuated Green, G (s)	44.7	44.7	44.7	53.3	53.3		53.2	53.2		53.2	53.2	
Effective Green, g (s)	44.7	44.7	44.7	53.3	53.3		53.2	53.2		53.2	53.2	
Actuated g/C Ratio	0.37	0.37	0.37	0.44	0.44		0.44	0.44		0.44	0.44	
Clearance Time (s)	6.8	6.8	6.8	3.0	6.8		6.7	6.7		6.7	6.7	
Vehicle Extension (s)	3.0	3.0	3.0	3.0	3.0		3.0	3.0		3.0	3.0	
Lane Grp Cap (vph)	125	686	483	331	820		517	751		337	778	
v/s Ratio Prot		0.17		0.01	c0.36			c0.21			0.03	
v/s Ratio Perm	0.07		0.01	0.09			0.10			0.03		
v/c Ratio	0.18	0.46	0.03	0.21	0.81		0.23	0.47		0.08	0.07	
Uniform Delay, d1	25.3	28.6	23.9	20.2	29.0		20.7	23.5		19.3	19.2	
Progression Factor	1.00	1.00	1.00	1.00	1.00		0.70	0.64		1.00	1.00	
Incremental Delay, d2	0.7	0.5	0.0	0.3	6.2		1.0	2.0		0.4	0.2	
Delay (s)	26.0	29.1	23.9	20.5	35.3		15.5	17.1		19.7	19.4	
Level of Service	C	C	C	C	D		B	B		B	B	
Approach Delay (s)		28.4			33.9			16.7			19.5	
Approach LOS		C			C			B			B	
Intersection Summary												
HCM 2000 Control Delay			26.9			HCM 2000 Level of Service		C				
HCM 2000 Volume to Capacity ratio			0.66									
Actuated Cycle Length (s)			120.0			Sum of lost time (s)		16.5				
Intersection Capacity Utilization			78.7%			ICU Level of Service		D				
Analysis Period (min)			15									

c Critical Lane Group

Queues

Future Total (2028) - Optimized

3: Clarkway Drive/Humber Station Road & Mayfield Road

PM Peak Hour

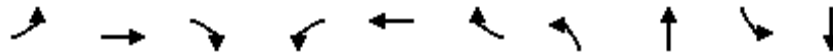

Lane Group	EBL	EBT	EBR	WBL	WBT	WBR	NBL	NBT	SBL	SBT
Lane Configurations	↔	↑↑↑	↔	↔	↑↑	↔	↔	↔	↔	↔
Traffic Volume (vph)	71	688	19	135	828	62	59	302	46	149
Future Volume (vph)	71	688	19	135	828	62	59	302	46	149
Lane Group Flow (vph)	73	709	20	139	854	64	61	477	47	290
Turn Type	Perm	NA	Perm	Perm	NA	Perm	Perm	NA	Perm	NA
Protected Phases		2			6			4		8
Permitted Phases	2		2	6		6	4		8	
Detector Phase	2	2	2	6	6	6	4	4	8	8
Switch Phase										
Minimum Initial (s)	12.0	12.0	12.0	12.0	12.0	12.0	8.0	8.0	8.0	8.0
Minimum Split (s)	27.3	27.3	27.3	27.3	27.3	27.3	26.0	26.0	26.0	26.0
Total Split (s)	62.0	62.0	62.0	62.0	62.0	62.0	58.0	58.0	58.0	58.0
Total Split (%)	51.7%	51.7%	51.7%	51.7%	51.7%	51.7%	48.3%	48.3%	48.3%	48.3%
Yellow Time (s)	4.6	4.6	4.6	4.6	4.6	4.6	4.2	4.2	4.2	4.2
All-Red Time (s)	2.7	2.7	2.7	2.7	2.7	2.7	2.8	2.8	2.8	2.8
Lost Time Adjust (s)	0.0	0.0	0.0	0.0	0.0	0.0	0.0	0.0	0.0	0.0
Total Lost Time (s)	7.3	7.3	7.3	7.3	7.3	7.3	7.0	7.0	7.0	7.0
Lead/Lag										
Lead-Lag Optimize?										
Recall Mode	C-Max	C-Max	C-Max	C-Max	C-Max	C-Max	None	None	None	None
v/c Ratio	0.32	0.28	0.03	0.42	0.47	0.08	0.27	0.84	0.46	0.56
Control Delay	22.1	15.1	2.3	22.7	18.1	4.3	31.0	49.3	46.5	39.1
Queue Delay	0.0	0.0	0.0	0.0	0.0	0.0	0.0	0.0	0.0	0.0
Total Delay	22.1	15.1	2.3	22.7	18.1	4.3	31.0	49.3	46.5	39.1
Queue Length 50th (m)	9.3	31.9	0.0	19.0	63.6	0.0	11.2	104.0	9.7	61.9
Queue Length 95th (m)	25.8	48.9	2.3	45.0	97.8	7.7	20.5	129.2	19.6	75.2
Internal Link Dist (m)		1635.6			198.0			1951.8		1542.4
Turn Bay Length (m)	150.0		105.0	150.0		115.0	75.0		105.0	
Base Capacity (vph)	227	2573	778	330	1807	757	302	744	137	691
Starvation Cap Reductn	0	0	0	0	0	0	0	0	0	0
Spillback Cap Reductn	0	0	0	0	0	0	0	0	0	0
Storage Cap Reductn	0	0	0	0	0	0	0	0	0	0
Reduced v/c Ratio	0.32	0.28	0.03	0.42	0.47	0.08	0.20	0.64	0.34	0.42

Intersection Summary

Cycle Length: 120

Actuated Cycle Length: 120

Offset: 0 (0%), Referenced to phase 2:EBTL and 6:WBTL, Start of Green

Natural Cycle: 55





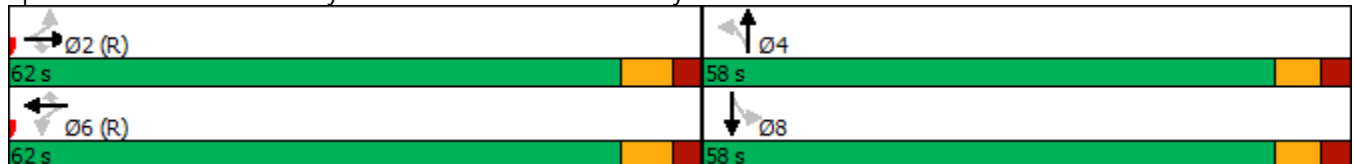





















Control Type: Actuated-Coordinated

Splits and Phases: 3: Clarkway Drive/Humber Station Road & Mayfield Road



HCM Signalized Intersection Capacity Analysis
 3: Clarkway Drive/Humber Station Road & Mayfield Road

Future Total (2028) - Optimized
 PM Peak Hour

												
Movement	EBL	EBT	EBR	WBL	WBT	WBR	NBL	NBT	NBR	SBL	SBT	SBR
Lane Configurations		  			 			 				
Traffic Volume (vph)	71	688	19	135	828	62	59	302	161	46	149	132
Future Volume (vph)	71	688	19	135	828	62	59	302	161	46	149	132
Ideal Flow (vphpl)	1900	1900	1900	1900	1900	1900	1900	1900	1900	1900	1900	1900
Lane Width	3.0	3.5	3.0	3.0	3.5	3.0	3.0	3.5	3.0	3.0	3.5	3.0
Total Lost time (s)	7.3	7.3	7.3	7.3	7.3	7.3	7.0	7.0		7.0	7.0	
Lane Util. Factor	1.00	0.91	1.00	1.00	0.95	1.00	1.00	1.00		1.00	1.00	
Frt	1.00	1.00	0.85	1.00	1.00	0.85	1.00	0.95		1.00	0.93	
Flt Protected	0.95	1.00	1.00	0.95	1.00	1.00	0.95	1.00		0.95	1.00	
Satd. Flow (prot)	1370	4580	1358	1546	3216	1299	1504	1712		1518	1626	
Flt Permitted	0.28	1.00	1.00	0.36	1.00	1.00	0.45	1.00		0.20	1.00	
Satd. Flow (perm)	405	4580	1358	589	3216	1299	713	1712		324	1626	
Peak-hour factor, PHF	0.97	0.97	0.97	0.97	0.97	0.97	0.97	0.97	0.97	0.97	0.97	0.97
Adj. Flow (vph)	73	709	20	139	854	64	61	311	166	47	154	136
RTOR Reduction (vph)	0	0	9	0	0	28	0	19	0	0	0	0
Lane Group Flow (vph)	73	709	11	139	854	36	61	458	0	47	290	0
Heavy Vehicles (%)	23%	12%	11%	9%	11%	16%	12%	4%	4%	11%	6%	9%
Turn Type	Perm	NA	Perm	Perm	NA	Perm	Perm	NA		Perm	NA	
Protected Phases		2			6			4			8	
Permitted Phases	2		2	6		6	4			8		
Actuated Green, G (s)	67.4	67.4	67.4	67.4	67.4	67.4	38.3	38.3		38.3	38.3	
Effective Green, g (s)	67.4	67.4	67.4	67.4	67.4	67.4	38.3	38.3		38.3	38.3	
Actuated g/C Ratio	0.56	0.56	0.56	0.56	0.56	0.56	0.32	0.32		0.32	0.32	
Clearance Time (s)	7.3	7.3	7.3	7.3	7.3	7.3	7.0	7.0		7.0	7.0	
Vehicle Extension (s)	3.0	3.0	3.0	3.0	3.0	3.0	3.0	3.0		3.0	3.0	
Lane Grp Cap (vph)	227	2572	762	330	1806	729	227	546		103	518	
v/s Ratio Prot		0.15			c0.27			c0.27			0.18	
v/s Ratio Perm	0.18		0.01	0.24		0.03	0.09			0.15		
v/c Ratio	0.32	0.28	0.01	0.42	0.47	0.05	0.27	0.84		0.46	0.56	
Uniform Delay, d1	14.1	13.6	11.6	15.1	15.7	11.9	30.4	38.0		32.6	33.9	
Progression Factor	1.00	1.00	1.00	1.00	1.00	1.00	1.00	1.00		1.04	1.06	
Incremental Delay, d2	3.7	0.3	0.0	3.9	0.9	0.1	0.6	10.9		3.2	1.3	
Delay (s)	17.8	13.9	11.7	19.0	16.6	12.0	31.1	48.8		37.2	37.3	
Level of Service	B	B	B	B	B	B	C	D		D	D	
Approach Delay (s)		14.2			16.6			46.8			37.3	
Approach LOS		B			B			D			D	
Intersection Summary												
HCM 2000 Control Delay			24.4				HCM 2000 Level of Service			C		
HCM 2000 Volume to Capacity ratio			0.61									
Actuated Cycle Length (s)			120.0			Sum of lost time (s)			14.3			
Intersection Capacity Utilization			89.1%			ICU Level of Service			E			
Analysis Period (min)			15									

c Critical Lane Group

Queues

Future Total (2028) - Optimized

4: Coleraine Drive & Mayfield Road

PM Peak Hour

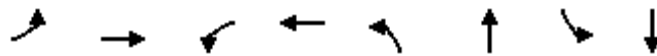

Lane Group	EBL	EBT	WBL	WBT	NBL	NBT	SBL	SBT
Lane Configurations	↖	↕	↖	↕	↖	↕	↖	↕
Traffic Volume (vph)	229	651	13	612	52	305	52	201
Future Volume (vph)	229	651	13	612	52	305	52	201
Lane Group Flow (vph)	241	716	14	727	55	343	55	486
Turn Type	pm+pt	NA	Perm	NA	Perm	NA	pm+pt	NA
Protected Phases	5	2		6		4	3	8
Permitted Phases	2		6		4		8	
Detector Phase	5	2	6	6	4	4	3	8
Switch Phase								
Minimum Initial (s)	5.0	12.0	12.0	12.0	12.0	12.0	5.0	12.0
Minimum Split (s)	8.0	37.0	37.0	37.0	37.0	37.0	8.0	37.0
Total Split (s)	12.0	80.0	68.0	68.0	36.0	36.0	14.0	50.0
Total Split (%)	9.2%	61.5%	52.3%	52.3%	27.7%	27.7%	10.8%	38.5%
Yellow Time (s)	3.0	4.6	4.6	4.6	4.2	4.2	3.0	4.2
All-Red Time (s)	0.0	2.4	2.4	2.4	2.8	2.8	0.0	2.8
Lost Time Adjust (s)	0.0	0.0	0.0	0.0	0.0	0.0	0.0	0.0
Total Lost Time (s)	3.0	7.0	7.0	7.0	7.0	7.0	3.0	7.0
Lead/Lag	Lead		Lag	Lag	Lag	Lag	Lead	
Lead-Lag Optimize?	Yes		Yes	Yes	Yes	Yes	Yes	
Recall Mode	None	C-Max	C-Max	C-Max	None	None	None	None
v/c Ratio	0.55	0.32	0.04	0.41	0.48	0.71	0.32	0.56
Control Delay	13.0	10.0	18.2	19.3	65.3	60.8	40.1	20.9
Queue Delay	0.0	0.0	0.0	0.0	0.0	0.0	0.0	0.0
Total Delay	13.0	10.0	18.2	19.3	65.3	60.8	40.1	20.9
Queue Length 50th (m)	22.1	40.4	1.8	59.6	13.9	46.5	11.5	25.9
Queue Length 95th (m)	39.6	58.8	6.1	86.0	27.7	61.0	21.6	41.1
Internal Link Dist (m)		290.4		1003.7		192.7		576.8
Turn Bay Length (m)	100.0		85.0		105.0		145.0	
Base Capacity (vph)	436	2271	342	1755	187	792	187	1187
Starvation Cap Reductn	0	0	0	0	0	0	0	0
Spillback Cap Reductn	0	0	0	0	0	0	0	0
Storage Cap Reductn	0	0	0	0	0	0	0	0
Reduced v/c Ratio	0.55	0.32	0.04	0.41	0.29	0.43	0.29	0.41

Intersection Summary

Cycle Length: 130
 Actuated Cycle Length: 130
 Offset: 116 (89%), Referenced to phase 2:EBTL and 6:WBTL, Start of Green
 Natural Cycle: 90
 Control Type: Actuated-Coordinated

























Splits and Phases: 4: Coleraine Drive & Mayfield Road



HCM Signalized Intersection Capacity Analysis

4: Coleraine Drive & Mayfield Road

Future Total (2028) - Optimized
PM Peak Hour

												
Movement	EBL	EBT	EBR	WBL	WBT	WBR	NBL	NBT	NBR	SBL	SBT	SBR
Lane Configurations		 			 			 			 	
Traffic Volume (vph)	229	651	29	13	612	79	52	305	21	52	201	260
Future Volume (vph)	229	651	29	13	612	79	52	305	21	52	201	260
Ideal Flow (vphpl)	1900	1900	1900	1900	1900	1900	1900	1900	1900	1900	1900	1900
Lane Width	3.0	3.5	3.0	3.0	3.5	3.0	3.0	3.5	3.0	3.0	3.5	3.0
Total Lost time (s)	3.0	7.0		7.0	7.0		7.0	7.0		3.0	7.0	
Lane Util. Factor	1.00	0.95		1.00	0.95		1.00	0.95		1.00	0.95	
Fr _t	1.00	0.99		1.00	0.98		1.00	0.99		1.00	0.92	
Fl _t Protected	0.95	1.00		0.95	1.00		0.95	1.00		0.95	1.00	
Satd. Flow (prot)	1440	3354		1560	3173		1685	3536		1348	3045	
Fl _t Permitted	0.32	1.00		0.38	1.00		0.48	1.00		0.32	1.00	
Satd. Flow (perm)	478	3354		623	3173		842	3536		456	3045	
Peak-hour factor, PHF	0.95	0.95	0.95	0.95	0.95	0.95	0.95	0.95	0.95	0.95	0.95	0.95
Adj. Flow (vph)	241	685	31	14	644	83	55	321	22	55	212	274
RTOR Reduction (vph)	0	2	0	0	6	0	0	4	0	0	211	0
Lane Group Flow (vph)	241	714	0	14	721	0	55	339	0	55	275	0
Heavy Vehicles (%)	17%	6%	0%	8%	9%	23%	0%	0%	0%	25%	0%	13%
Turn Type	pm+pt	NA		Perm	NA		Perm	NA		pm+pt	NA	
Protected Phases	5	2			6			4		3	8	
Permitted Phases	2			6			4			8		
Actuated Green, G (s)	87.4	87.4		71.1	71.1		17.7	17.7		28.6	28.6	
Effective Green, g (s)	87.4	87.4		71.1	71.1		17.7	17.7		28.6	28.6	
Actuated g/C Ratio	0.67	0.67		0.55	0.55		0.14	0.14		0.22	0.22	
Clearance Time (s)	3.0	7.0		7.0	7.0		7.0	7.0		3.0	7.0	
Vehicle Extension (s)	3.0	3.0		3.0	3.0		3.0	3.0		3.0	3.0	
Lane Grp Cap (vph)	419	2254		340	1735		114	481		154	669	
v/s Ratio Prot	c0.06	0.21			0.23			c0.10		0.02	c0.09	
v/s Ratio Perm	c0.33			0.02			0.07			0.06		
v/c Ratio	0.58	0.32		0.04	0.42		0.48	0.70		0.36	0.41	
Uniform Delay, d ₁	9.3	8.9		13.7	17.3		51.9	53.6		41.5	43.5	
Progression Factor	1.00	1.00		1.00	1.00		1.00	1.00		1.00	1.00	
Incremental Delay, d ₂	1.9	0.4		0.2	0.7		3.2	4.6		1.4	0.4	
Delay (s)	11.2	9.2		13.9	18.0		55.1	58.3		43.0	43.9	
Level of Service	B	A		B	B		E	E		D	D	
Approach Delay (s)		9.7			17.9			57.9			43.8	
Approach LOS		A			B			E			D	
Intersection Summary												
HCM 2000 Control Delay			26.3			HCM 2000 Level of Service				C		
HCM 2000 Volume to Capacity ratio			0.60									
Actuated Cycle Length (s)			130.0			Sum of lost time (s)				20.0		
Intersection Capacity Utilization			76.9%			ICU Level of Service				D		
Analysis Period (min)			15									

c Critical Lane Group

Queues

Future Total (2028) - Optimized

5: Coleraine Drive & Private Access/George Bolton Parkway

PM Peak Hour



Lane Group	EBL	EBT	WBL	WBT	NBL	NBT	SBL	SBT	SBR
Lane Configurations	↖	↗	↖	↗	↖	↗	↖	↗	↗
Traffic Volume (vph)	7	26	61	9	6	539	177	499	1
Future Volume (vph)	7	26	61	9	6	539	177	499	1
Lane Group Flow (vph)	8	58	73	198	7	733	213	601	1
Turn Type	Perm	NA	Perm	NA	Perm	NA	Perm	NA	Perm
Protected Phases		8		4		6		2	
Permitted Phases	8		4		6		2		2
Detector Phase	8	8	4	4	6	6	2	2	2
Switch Phase									
Minimum Initial (s)	8.0	8.0	12.0	12.0	12.0	12.0	12.0	12.0	12.0
Minimum Split (s)	32.5	32.5	32.5	32.5	34.2	34.2	33.7	33.7	33.7
Total Split (s)	45.0	45.0	45.0	45.0	55.0	55.0	55.0	55.0	55.0
Total Split (%)	45.0%	45.0%	45.0%	45.0%	55.0%	55.0%	55.0%	55.0%	55.0%
Yellow Time (s)	4.0	4.0	4.0	4.0	4.2	4.2	4.2	4.2	4.2
All-Red Time (s)	3.5	3.5	3.5	3.5	2.5	2.5	2.5	2.5	2.5
Lost Time Adjust (s)	0.0	0.0	0.0	0.0	0.0	0.0	0.0	0.0	0.0
Total Lost Time (s)	7.5	7.5	7.5	7.5	6.7	6.7	6.7	6.7	6.7
Lead/Lag									
Lead-Lag Optimize?									
Recall Mode	None	None	None	None	C-Max	C-Max	C-Max	C-Max	C-Max
v/c Ratio	0.07	0.24	0.48	0.54	0.02	0.33	0.48	0.26	0.00
Control Delay	37.4	25.7	50.0	12.8	4.8	5.6	10.8	5.3	0.0
Queue Delay	0.0	0.0	0.0	0.0	0.0	0.0	0.0	0.0	0.0
Total Delay	37.4	25.7	50.0	12.8	4.8	5.6	10.8	5.3	0.0
Queue Length 50th (m)	1.5	5.8	14.2	2.0	0.3	21.9	14.7	17.5	0.0
Queue Length 95th (m)	5.3	14.8	24.9	16.8	1.7	33.5	33.0	27.3	0.0
Internal Link Dist (m)		152.4		468.8		784.9		1711.9	
Turn Bay Length (m)	70.0		105.0		75.0		100.0		100.0
Base Capacity (vph)	322	619	423	675	362	2244	445	2280	1101
Starvation Cap Reductn	0	0	0	0	0	0	0	0	0
Spillback Cap Reductn	0	0	0	0	0	0	0	0	0
Storage Cap Reductn	0	0	0	0	0	0	0	0	0
Reduced v/c Ratio	0.02	0.09	0.17	0.29	0.02	0.33	0.48	0.26	0.00

Intersection Summary

Cycle Length: 100
 Actuated Cycle Length: 100
 Offset: 0 (0%), Referenced to phase 2:SBTL and 6:NBTL, Start of Green
 Natural Cycle: 75
 Control Type: Actuated-Coordinated



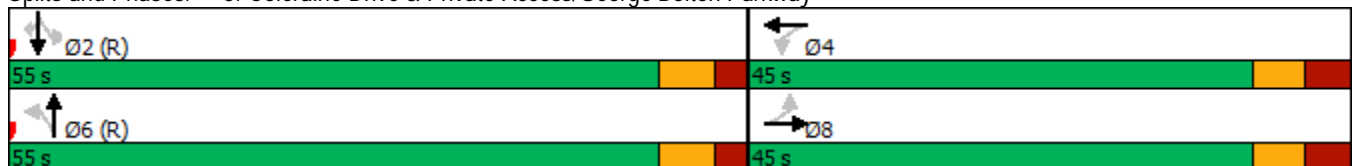



















Splits and Phases: 5: Coleraine Drive & Private Access/George Bolton Parkway



HCM Signalized Intersection Capacity Analysis

5: Coleraine Drive & Private Access/George Bolton Parkway

Future Total (2028) - Optimized
PM Peak Hour

												
Movement	EBL	EBT	EBR	WBL	WBT	WBR	NBL	NBT	NBR	SBL	SBT	SBR
Lane Configurations												
Traffic Volume (vph)	7	26	22	61	9	155	6	539	70	177	499	1
Future Volume (vph)	7	26	22	61	9	155	6	539	70	177	499	1
Ideal Flow (vphpl)	1900	1900	1900	1900	1900	1900	1900	1900	1900	1900	1900	1900
Lane Width	3.0	3.5	3.0	3.0	3.5	3.0	3.0	3.5	3.0	3.0	3.5	3.0
Total Lost time (s)	7.5	7.5		7.5	7.5		6.7	6.7		6.7	6.7	6.7
Lane Util. Factor	1.00	1.00		1.00	1.00		1.00	0.95		1.00	0.95	1.00
Fr't	1.00	0.93		1.00	0.86		1.00	0.98		1.00	1.00	0.85
Flt Protected	0.95	1.00		0.95	1.00		0.95	1.00		0.95	1.00	1.00
Satd. Flow (prot)	1685	1608		1491	1491		1123	3102		1589	3159	1507
Flt Permitted	0.49	1.00		0.72	1.00		0.42	1.00		0.37	1.00	1.00
Satd. Flow (perm)	861	1608		1129	1491		502	3102		617	3159	1507
Peak-hour factor, PHF	0.83	0.83	0.83	0.83	0.83	0.83	0.83	0.83	0.83	0.83	0.83	0.83
Adj. Flow (vph)	8	31	27	73	11	187	7	649	84	213	601	1
RTOR Reduction (vph)	0	23	0	0	162	0	0	5	0	0	0	0
Lane Group Flow (vph)	8	35	0	73	36	0	7	728	0	213	601	1
Heavy Vehicles (%)	0%	4%	14%	13%	11%	8%	50%	13%	14%	6%	13%	0%
Turn Type	Perm	NA		Perm	NA		Perm	NA		Perm	NA	Perm
Protected Phases		8			4			6			2	
Permitted Phases	8			4			6			2		2
Actuated Green, G (s)	13.6	13.6		13.6	13.6		72.2	72.2		72.2	72.2	72.2
Effective Green, g (s)	13.6	13.6		13.6	13.6		72.2	72.2		72.2	72.2	72.2
Actuated g/C Ratio	0.14	0.14		0.14	0.14		0.72	0.72		0.72	0.72	0.72
Clearance Time (s)	7.5	7.5		7.5	7.5		6.7	6.7		6.7	6.7	6.7
Vehicle Extension (s)	3.0	3.0		3.0	3.0		3.0	3.0		3.0	3.0	3.0
Lane Grp Cap (vph)	117	218		153	202		362	2239		445	2280	1088
v/s Ratio Prot		0.02			0.02			0.23			0.19	
v/s Ratio Perm	0.01			c0.06			0.01			c0.35		0.00
v/c Ratio	0.07	0.16		0.48	0.18		0.02	0.33		0.48	0.26	0.00
Uniform Delay, d1	37.7	38.1		39.9	38.3		3.9	5.0		5.9	4.8	3.9
Progression Factor	1.00	1.00		1.00	1.00		1.00	1.00		1.00	1.00	1.00
Incremental Delay, d2	0.2	0.3		2.3	0.4		0.1	0.4		3.7	0.3	0.0
Delay (s)	37.9	38.5		42.3	38.7		4.0	5.4		9.6	5.1	3.9
Level of Service	D	D		D	D		A	A		A	A	A
Approach Delay (s)		38.4			39.7			5.4			6.2	
Approach LOS		D			D			A			A	

Intersection Summary		
HCM 2000 Control Delay	11.8	HCM 2000 Level of Service
HCM 2000 Volume to Capacity ratio	0.48	B
Actuated Cycle Length (s)	100.0	Sum of lost time (s)
Intersection Capacity Utilization	54.6%	14.2
Analysis Period (min)	15	ICU Level of Service
		A

c Critical Lane Group

Queues
6: Highway 50 & George Bolton Parkway/Private Access

Future Total (2028) - Optimized
PM Peak Hour



Lane Group	EBL	EBT	WBT	NBL	NBT	SBL	SBT	SBR
Lane Configurations								
Traffic Volume (vph)	225	0	0	135	1320	1	983	169
Future Volume (vph)	225	0	0	135	1320	1	983	169
Lane Group Flow (vph)	234	218	7	141	1375	1	1024	176
Turn Type	Perm	NA	NA	pm+pt	NA	Perm	NA	Perm
Protected Phases		8	4	1	6		2	
Permitted Phases	8			6		2		2
Detector Phase	8	8	4	1	6	2	2	2
Switch Phase								
Minimum Initial (s)	8.0	8.0	8.0	5.0	12.0	12.0	12.0	12.0
Minimum Split (s)	32.6	32.6	32.6	8.0	27.3	27.3	27.3	27.3
Total Split (s)	35.0	35.0	35.0	10.0	85.0	75.0	75.0	75.0
Total Split (%)	29.2%	29.2%	29.2%	8.3%	70.8%	62.5%	62.5%	62.5%
Yellow Time (s)	4.0	4.0	4.0	3.0	4.0	4.0	4.0	4.0
All-Red Time (s)	2.6	2.6	2.6	0.0	2.3	2.3	2.3	2.3
Lost Time Adjust (s)	0.0	0.0	0.0	0.0	0.0	0.0	0.0	0.0
Total Lost Time (s)	6.6	6.6	6.6	3.0	6.3	6.3	6.3	6.3
Lead/Lag				Lead		Lag	Lag	Lag
Lead-Lag Optimize?				Yes		Yes	Yes	Yes
Recall Mode	None	None	None	None	C-Max	C-Max	C-Max	C-Max
v/c Ratio	0.86	0.49	0.02	0.48	0.59	0.01	0.49	0.19
Control Delay	73.2	11.6	0.1	11.8	11.8	11.0	15.3	2.2
Queue Delay	0.0	0.0	0.0	0.0	0.0	0.0	0.0	0.0
Total Delay	73.2	11.6	0.1	11.8	11.8	11.0	15.3	2.2
Queue Length 50th (m)	55.1	4.9	0.0	10.6	91.2	0.1	77.0	0.0
Queue Length 95th (m)	#92.1	26.9	0.0	18.9	116.1	0.9	94.9	9.7
Internal Link Dist (m)		846.5	43.0		1045.6		1307.8	
Turn Bay Length (m)	85.0			40.0		135.0		60.0
Base Capacity (vph)	312	479	434	294	2330	183	2073	934
Starvation Cap Reductn	0	0	0	0	0	0	0	0
Spillback Cap Reductn	0	0	0	0	0	0	0	0
Storage Cap Reductn	0	0	0	0	0	0	0	0
Reduced v/c Ratio	0.75	0.46	0.02	0.48	0.59	0.01	0.49	0.19

Intersection Summary





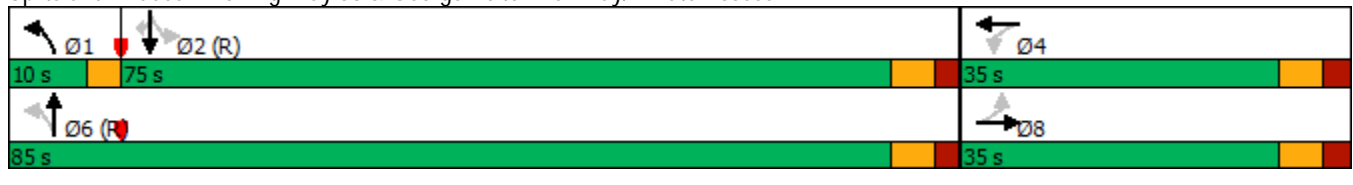















Cycle Length: 120
 Actuated Cycle Length: 120
 Offset: 116 (97%), Referenced to phase 2:SBTL and 6:NBTL, Start of Green
 Natural Cycle: 70
 Control Type: Actuated-Coordinated
 # 95th percentile volume exceeds capacity, queue may be longer.
 Queue shown is maximum after two cycles.

Splits and Phases: 6: Highway 50 & George Bolton Parkway/Private Access















HCM Signalized Intersection Capacity Analysis
 6: Highway 50 & George Bolton Parkway/Private Access

Future Total (2028) - Optimized
 PM Peak Hour

													
Movement	EBL	EBT	EBR	WBL	WBT	WBR	NBL	NBT	NBR	SBL	SBT	SBR	
Lane Configurations													
Traffic Volume (vph)	225	0	209	0	0	7	135	1320	0	1	983	169	
Future Volume (vph)	225	0	209	0	0	7	135	1320	0	1	983	169	
Ideal Flow (vphpl)	1900	1900	1900	1900	1900	1900	1900	1900	1900	1900	1900	1900	
Lane Width	3.0	3.5	3.0	3.0	3.5	3.0	3.0	3.5	3.0	3.0	3.5	3.0	
Total Lost time (s)	6.6	6.6			6.6		3.0	6.3		6.3	6.3	6.3	
Lane Util. Factor	1.00	1.00			1.00		1.00	0.95		1.00	0.95	1.00	
Frbp, ped/bikes	1.00	0.99			1.00		1.00	1.00		1.00	1.00	0.98	
Flpb, ped/bikes	1.00	1.00			1.00		1.00	1.00		1.00	1.00	1.00	
Frt	1.00	0.85			0.86		1.00	1.00		1.00	1.00	0.85	
Flt Protected	0.95	1.00			1.00		0.95	1.00		0.95	1.00	1.00	
Satd. Flow (prot)	1668	1405			1625		1404	3400		1685	3466	1444	
Flt Permitted	0.75	1.00			1.00		0.22	1.00		0.17	1.00	1.00	
Satd. Flow (perm)	1322	1405			1625		318	3400		307	3466	1444	
Peak-hour factor, PHF	0.96	0.96	0.96	0.96	0.96	0.96	0.96	0.96	0.96	0.96	0.96	0.96	
Adj. Flow (vph)	234	0	218	0	0	7	141	1375	0	1	1024	176	
RTOR Reduction (vph)	0	153	0	0	6	0	0	0	0	0	0	71	
Lane Group Flow (vph)	234	65	0	0	1	0	141	1375	0	1	1024	105	
Confl. Peds. (#/hr)			2	2			1					1	
Heavy Vehicles (%)	1%	0%	12%	0%	0%	0%	20%	5%	0%	0%	3%	2%	
Turn Type	Perm	NA			NA		pm+pt	NA		Perm	NA	Perm	
Protected Phases		8			4		1	6			2		
Permitted Phases	8			4			6			2		2	
Actuated Green, G (s)	24.9	24.9			24.9		82.2	82.2		71.8	71.8	71.8	
Effective Green, g (s)	24.9	24.9			24.9		82.2	82.2		71.8	71.8	71.8	
Actuated g/C Ratio	0.21	0.21			0.21		0.69	0.69		0.60	0.60	0.60	
Clearance Time (s)	6.6	6.6			6.6		3.0	6.3		6.3	6.3	6.3	
Vehicle Extension (s)	3.0	3.0			3.0		3.0	3.0		3.0	3.0	3.0	
Lane Grp Cap (vph)	274	291			337		284	2329		183	2073	863	
v/s Ratio Prot		0.05			0.00		0.03	c0.40			0.30		
v/s Ratio Perm	c0.18						0.31			0.00		0.07	
v/c Ratio	0.85	0.22			0.00		0.50	0.59		0.01	0.49	0.12	
Uniform Delay, d1	45.8	39.5			37.7		8.5	10.0		9.7	13.7	10.4	
Progression Factor	1.00	1.00			1.00		1.00	1.00		1.00	1.00	1.00	
Incremental Delay, d2	21.9	0.4			0.0		1.4	1.1		0.1	0.8	0.3	
Delay (s)	67.7	39.9			37.7		9.9	11.1		9.8	14.6	10.7	
Level of Service	E	D			D		A	B		A	B	B	
Approach Delay (s)		54.3			37.7			11.0			14.0		
Approach LOS		D			D			B			B		
Intersection Summary													
HCM 2000 Control Delay			18.4				HCM 2000 Level of Service				B		
HCM 2000 Volume to Capacity ratio			0.67										
Actuated Cycle Length (s)			120.0				Sum of lost time (s)			15.9			
Intersection Capacity Utilization			81.8%				ICU Level of Service			D			
Analysis Period (min)			15										
c Critical Lane Group													

HCM Unsignalized Intersection Capacity Analysis
 9: Humber Station Road & Subject Lands Site Access 1

Future Total (2028) - Optimized
 PM Peak Hour

						
Movement	WBL	WBR	NBT	NBR	SBL	SBT
Lane Configurations						
Traffic Volume (veh/h)	239	147	322	113	64	88
Future Volume (Veh/h)	239	147	322	113	64	88
Sign Control	Stop		Free		Free	
Grade	0%		0%		0%	
Peak Hour Factor	1.00	1.00	1.00	1.00	1.00	1.00
Hourly flow rate (vph)	239	147	322	113	64	88
Pedestrians						
Lane Width (m)						
Walking Speed (m/s)						
Percent Blockage						
Right turn flare (veh)						
Median type	None			None		
Median storage veh						
Upstream signal (m)						
pX, platoon unblocked						
vC, conflicting volume	538	322			435	
vC1, stage 1 conf vol						
vC2, stage 2 conf vol						
vCu, unblocked vol	538	322			435	
tC, single (s)	6.5	6.3			4.3	
tC, 2 stage (s)						
tF (s)	3.6	3.4			2.4	
p0 queue free %	48	79			94	
cM capacity (veh/h)	460	701			1021	
Direction, Lane #	WB 1	WB 2	NB 1	NB 2	SB 1	SB 2
Volume Total	239	147	322	113	64	88
Volume Left	239	0	0	0	64	0
Volume Right	0	147	0	113	0	0
cSH	460	701	1700	1700	1021	1700
Volume to Capacity	0.52	0.21	0.19	0.07	0.06	0.05
Queue Length 95th (m)	23.5	6.3	0.0	0.0	1.6	0.0
Control Delay (s)	21.0	11.5	0.0	0.0	8.8	0.0
Lane LOS	C	B			A	
Approach Delay (s)	17.4		0.0	3.7		
Approach LOS	C					
Intersection Summary						
Average Delay			7.5			
Intersection Capacity Utilization			43.7%	ICU Level of Service		A
Analysis Period (min)			15			

HCM Unsignalized Intersection Capacity Analysis
 24: Mayfield Road & Triangle Lands

Future Total (2028) - Optimized
 PM Peak Hour



Movement	EBL	EBT	WBT	WBR	SBL	SBR	
Lane Configurations	↵	↑↑	↑↑		↵	↵	
Traffic Volume (veh/h)	85	810	858	57	75	167	
Future Volume (Veh/h)	85	810	858	57	75	167	
Sign Control		Free	Free		Stop		
Grade		0%	0%		0%		
Peak Hour Factor	1.00	1.00	1.00	1.00	1.00	1.00	
Hourly flow rate (vph)	85	810	858	57	75	167	
Pedestrians							
Lane Width (m)							
Walking Speed (m/s)							
Percent Blockage							
Right turn flare (veh)							
Median type		None	None				
Median storage (veh)							
Upstream signal (m)			314				
pX, platoon unblocked	0.90				0.90	0.90	
vC, conflicting volume	915				1462	458	
vC1, stage 1 conf vol							
vC2, stage 2 conf vol							
vCu, unblocked vol	680				1288	171	
tC, single (s)	4.4				7.1	7.2	
tC, 2 stage (s)							
tF (s)	2.3				3.6	3.4	
p0 queue free %	89				32	77	
cM capacity (veh/h)	748				111	725	
Direction, Lane #	EB 1	EB 2	EB 3	WB 1	WB 2	SB 1	SB 2
Volume Total	85	405	405	572	343	75	167
Volume Left	85	0	0	0	0	75	0
Volume Right	0	0	0	0	57	0	167
cSH	748	1700	1700	1700	1700	111	725
Volume to Capacity	0.11	0.24	0.24	0.34	0.20	0.68	0.23
Queue Length 95th (m)	3.1	0.0	0.0	0.0	0.0	28.1	7.1
Control Delay (s)	10.4	0.0	0.0	0.0	0.0	87.8	11.4
Lane LOS	B					F	B
Approach Delay (s)	1.0			0.0		35.1	
Approach LOS						E	
Intersection Summary							
Average Delay			4.6				
Intersection Capacity Utilization			44.4%		ICU Level of Service		A
Analysis Period (min)			15				

Queues

Future Total (2033) -Optimized

1: Coleraine Drive & Healey Road

AM Peak Hour

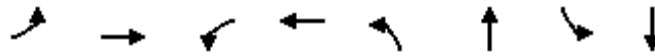

Lane Group	EBL	EBT	WBL	WBT	NBL	NBT	SBL	SBT
Lane Configurations	↖	↗	↖	↗	↖	↗	↖	↗
Traffic Volume (vph)	207	409	51	215	77	144	64	330
Future Volume (vph)	207	409	51	215	77	144	64	330
Lane Group Flow (vph)	223	752	55	255	83	184	69	696
Turn Type	pm+pt	NA	Perm	NA	pm+pt	NA	Perm	NA
Protected Phases	3	8		4	1	6		2
Permitted Phases	8		4		6		2	
Detector Phase	3	8	4	4	1	6	2	2
Switch Phase								
Minimum Initial (s)	5.0	8.0	8.0	8.0	5.0	8.0	8.0	8.0
Minimum Split (s)	9.5	32.8	32.8	32.8	9.5	36.7	36.7	36.7
Total Split (s)	10.0	71.0	61.0	61.0	10.0	49.0	39.0	39.0
Total Split (%)	8.3%	59.2%	50.8%	50.8%	8.3%	40.8%	32.5%	32.5%
Yellow Time (s)	3.0	4.0	4.0	4.0	3.0	4.6	4.6	4.6
All-Red Time (s)	0.0	2.8	2.8	2.8	0.0	2.1	2.1	2.1
Lost Time Adjust (s)	0.0	0.0	0.0	0.0	0.0	0.0	0.0	0.0
Total Lost Time (s)	3.0	6.8	6.8	6.8	3.0	6.7	6.7	6.7
Lead/Lag	Lead		Lag	Lag	Lead		Lag	Lag
Lead-Lag Optimize?	Yes		Yes	Yes	Yes		Yes	Yes
Recall Mode	None	None	None	None	None	C-Max	C-Max	C-Max
v/c Ratio	0.46	0.89	0.59	0.38	0.33	0.17	0.24	0.62
Control Delay	10.3	27.2	54.1	25.5	26.2	22.3	36.1	28.1
Queue Delay	0.0	0.0	0.0	0.0	0.0	0.0	0.0	0.0
Total Delay	10.3	27.2	54.1	25.5	26.2	22.3	36.1	28.1
Queue Length 50th (m)	22.7	163.7	10.2	41.5	12.5	13.8	13.3	58.9
Queue Length 95th (m)	m25.0	m186.9	#29.4	59.4	24.9	23.6	27.7	83.5
Internal Link Dist (m)		823.7		424.0		1711.9		1121.0
Turn Bay Length (m)	55.0		50.0		80.0		155.0	
Base Capacity (vph)	481	938	106	770	250	1093	293	1131
Starvation Cap Reductn	0	0	0	0	0	0	0	0
Spillback Cap Reductn	0	0	0	0	0	0	0	0
Storage Cap Reductn	0	0	0	0	0	0	0	0
Reduced v/c Ratio	0.46	0.80	0.52	0.33	0.33	0.17	0.24	0.62

Intersection Summary





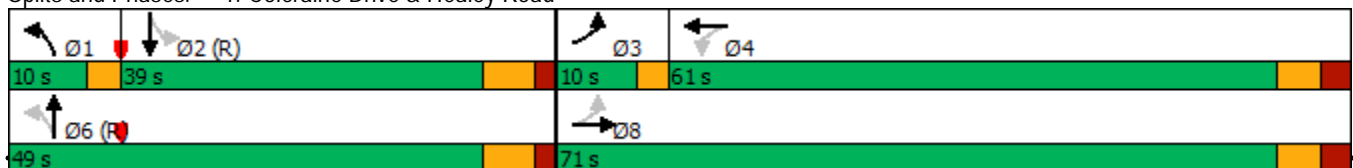

















Cycle Length: 120
 Actuated Cycle Length: 120
 Offset: 0 (0%), Referenced to phase 2:SBTL and 6:NBTL, Start of Green
 Natural Cycle: 90
 Control Type: Actuated-Coordinated
 # 95th percentile volume exceeds capacity, queue may be longer.
 Queue shown is maximum after two cycles.
 m Volume for 95th percentile queue is metered by upstream signal.

Splits and Phases: 1: Coleraine Drive & Healey Road



HCM Signalized Intersection Capacity Analysis
1: Coleraine Drive & Healey Road

Future Total (2033) -Optimized
AM Peak Hour

													
Movement	EBL	EBT	EBR	WBL	WBT	WBR	NBL	NBT	NBR	SBL	SBT	SBR	
Lane Configurations													
Traffic Volume (vph)	207	409	290	51	215	22	77	144	27	64	330	317	
Future Volume (vph)	207	409	290	51	215	22	77	144	27	64	330	317	
Ideal Flow (vphpl)	1900	1900	1900	1900	1900	1900	1900	1900	1900	1900	1900	1900	
Lane Width	3.0	3.5	3.0	3.0	3.5	3.0	3.0	3.5	3.0	3.0	3.5	3.0	
Total Lost time (s)	3.0	6.8		6.8	6.8		3.0	6.7		6.7	6.7		
Lane Util. Factor	1.00	1.00		1.00	1.00		1.00	0.95		1.00	0.95		
Flt	1.00	0.94		1.00	0.99		1.00	0.98		1.00	0.93		
Flt Protected	0.95	1.00		0.95	1.00		0.95	1.00		0.95	1.00		
Satd. Flow (prot)	1604	1713		1404	1698		1604	2665		1316	3004		
Flt Permitted	0.51	1.00		0.16	1.00		0.23	1.00		0.64	1.00		
Satd. Flow (perm)	853	1713		235	1698		393	2665		881	3004		
Peak-hour factor, PHF	0.93	0.93	0.93	0.93	0.93	0.93	0.93	0.93	0.93	0.93	0.93	0.93	
Adj. Flow (vph)	223	440	312	55	231	24	83	155	29	69	355	341	
RTOR Reduction (vph)	0	24	0	0	4	0	0	12	0	0	132	0	
Lane Group Flow (vph)	223	728	0	55	251	0	83	172	0	69	564	0	
Heavy Vehicles (%)	5%	2%	4%	20%	3%	68%	5%	33%	19%	28%	16%	4%	
Turn Type	pm+pt	NA		Perm	NA		pm+pt	NA		Perm	NA		
Protected Phases	3	8			4		1	6			2		
Permitted Phases	8			4			6			2			
Actuated Green, G (s)	57.8	57.8		47.8	47.8		48.7	48.7		39.4	39.4		
Effective Green, g (s)	57.8	57.8		47.8	47.8		48.7	48.7		39.4	39.4		
Actuated g/C Ratio	0.48	0.48		0.40	0.40		0.41	0.41		0.33	0.33		
Clearance Time (s)	3.0	6.8		6.8	6.8		3.0	6.7		6.7	6.7		
Vehicle Extension (s)	3.0	3.0		3.0	3.0		3.0	3.0		3.0	3.0		
Lane Grp Cap (vph)	454	825		93	676		223	1081		289	986		
v/s Ratio Prot	0.03	c0.42			0.15		c0.02	0.06			c0.19		
v/s Ratio Perm	0.21			0.23			0.13			0.08			
v/c Ratio	0.49	0.88		0.59	0.37		0.37	0.16		0.24	0.57		
Uniform Delay, d1	20.9	28.0		28.4	25.5		23.7	22.6		29.4	33.3		
Progression Factor	0.50	0.67		1.00	1.00		1.00	1.00		1.00	1.00		
Incremental Delay, d2	0.6	8.0		9.7	0.3		1.0	0.3		1.9	2.4		
Delay (s)	11.0	26.9		38.1	25.8		24.7	23.0		31.3	35.7		
Level of Service	B	C		D	C		C	C		C	D		
Approach Delay (s)		23.3			28.0			23.5			35.3		
Approach LOS		C			C			C			D		
Intersection Summary													
HCM 2000 Control Delay			27.9									HCM 2000 Level of Service	C
HCM 2000 Volume to Capacity ratio			0.76										
Actuated Cycle Length (s)			120.0									Sum of lost time (s)	19.5
Intersection Capacity Utilization			89.7%									ICU Level of Service	E
Analysis Period (min)			15										
c	Critical Lane Group												

Queues
2: Humber Station Road & Healey Road

Future Total (2033) -Optimized
AM Peak Hour

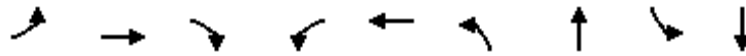

Lane Group	EBL	EBT	EBR	WBL	WBT	NBL	NBT	SBL	SBT
Lane Configurations	↖	↑	↗	↖	↗	↖	↗	↖	↗
Traffic Volume (vph)	4	729	165	287	329	83	20	83	213
Future Volume (vph)	4	729	165	287	329	83	20	83	213
Lane Group Flow (vph)	4	784	177	309	358	89	205	89	233
Turn Type	Perm	NA	Perm	pm+pt	NA	Perm	NA	Perm	NA
Protected Phases		4		3	8		2		6
Permitted Phases	4		4	8		2		6	
Detector Phase	4	4	4	3	8	2	2	6	6
Switch Phase									
Minimum Initial (s)	8.0	8.0	8.0	5.0	8.0	8.0	8.0	5.0	5.0
Minimum Split (s)	24.8	24.8	24.8	9.5	24.8	24.7	24.7	24.8	24.8
Total Split (s)	65.0	65.0	65.0	25.0	90.0	30.0	30.0	30.0	30.0
Total Split (%)	54.2%	54.2%	54.2%	20.8%	75.0%	25.0%	25.0%	25.0%	25.0%
Yellow Time (s)	4.0	4.0	4.0	3.0	4.0	4.6	4.6	4.6	4.6
All-Red Time (s)	2.8	2.8	2.8	0.0	2.8	2.1	2.1	2.1	2.1
Lost Time Adjust (s)	0.0	0.0	0.0	0.0	0.0	0.0	0.0	0.0	0.0
Total Lost Time (s)	6.8	6.8	6.8	3.0	6.8	6.7	6.7	6.7	6.7
Lead/Lag	Lag	Lag	Lag	Lead					
Lead-Lag Optimize?	Yes	Yes	Yes	Yes					
Recall Mode	None	None	None	None	None	C-Max	C-Max	C-Max	C-Max
v/c Ratio	0.01	0.93	0.26	0.93	0.30	0.52	0.42	0.42	0.54
Control Delay	16.2	47.9	12.9	68.4	7.3	53.8	13.4	48.8	47.3
Queue Delay	0.0	0.0	0.0	0.0	0.0	0.0	0.0	0.0	0.0
Total Delay	16.2	47.9	12.9	68.4	7.3	53.8	13.4	48.8	47.3
Queue Length 50th (m)	0.5	170.0	15.6	60.2	30.6	20.5	8.4	19.8	53.3
Queue Length 95th (m)	2.6	#250.3	30.3	#108.6	39.2	#45.2	24.7	38.2	81.8
Internal Link Dist (m)		465.5			505.1		463.9		452.2
Turn Bay Length (m)	30.0		30.0	60.0		30.0		30.0	
Base Capacity (vph)	376	893	715	355	1271	170	490	214	435
Starvation Cap Reductn	0	0	0	0	0	0	0	0	0
Spillback Cap Reductn	0	0	0	0	0	0	0	0	0
Storage Cap Reductn	0	0	0	0	0	0	0	0	0
Reduced v/c Ratio	0.01	0.88	0.25	0.87	0.28	0.52	0.42	0.42	0.54

Intersection Summary

Cycle Length: 120
 Actuated Cycle Length: 120
 Offset: 0 (0%), Referenced to phase 2:NBTL and 6:SBTL, Start of Green
 Natural Cycle: 90
 Control Type: Actuated-Coordinated
 # 95th percentile volume exceeds capacity, queue may be longer.
 Queue shown is maximum after two cycles.



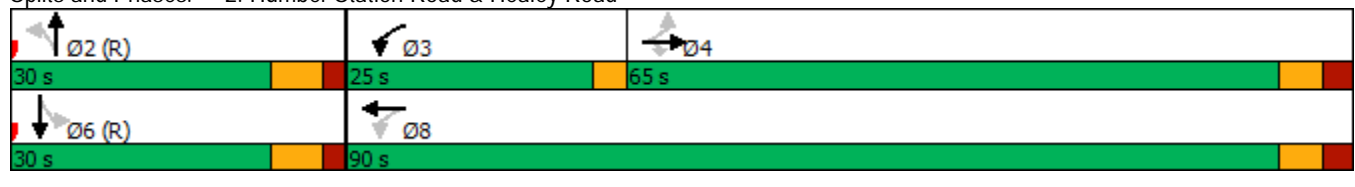

















Splits and Phases: 2: Humber Station Road & Healey Road



HCM Signalized Intersection Capacity Analysis

2: Humber Station Road & Healey Road

Future Total (2033) -Optimized
AM Peak Hour

												
Movement	EBL	EBT	EBR	WBL	WBT	WBR	NBL	NBT	NBR	SBL	SBT	SBR
Lane Configurations												
Traffic Volume (vph)	4	729	165	287	329	4	83	20	170	83	213	4
Future Volume (vph)	4	729	165	287	329	4	83	20	170	83	213	4
Ideal Flow (vphpl)	1900	1900	1900	1900	1900	1900	1900	1900	1900	1900	1900	1900
Lane Width	3.0	3.5	3.0	3.0	3.5	3.0	3.0	3.5	3.0	3.0	3.5	3.0
Total Lost time (s)	6.8	6.8	6.8	3.0	6.8		6.7	6.7		6.7	6.7	
Lane Util. Factor	1.00	1.00	1.00	1.00	1.00		1.00	1.00		1.00	1.00	
Frt	1.00	1.00	0.85	1.00	1.00		1.00	0.87		1.00	1.00	
Flt Protected	0.95	1.00	1.00	0.95	1.00		0.95	1.00		0.95	1.00	
Satd. Flow (prot)	1348	1842	1409	1589	1834		1491	1494		1685	1856	
Flt Permitted	0.55	1.00	1.00	0.08	1.00		0.46	1.00		0.52	1.00	
Satd. Flow (perm)	776	1842	1409	127	1834		725	1494		914	1856	
Peak-hour factor, PHF	0.93	0.93	0.93	0.93	0.93	0.93	0.93	0.93	0.93	0.93	0.93	0.93
Adj. Flow (vph)	4	784	177	309	354	4	89	22	183	89	229	4
RTOR Reduction (vph)	0	0	33	0	0	0	0	140	0	0	1	0
Lane Group Flow (vph)	4	784	144	309	358	0	89	65	0	89	232	0
Heavy Vehicles (%)	25%	2%	7%	6%	2%	25%	13%	0%	10%	0%	1%	0%
Turn Type	Perm	NA	Perm	pm+pt	NA		Perm	NA		Perm	NA	
Protected Phases		4		3	8			2			6	
Permitted Phases	4		4	8			2			6		
Actuated Green, G (s)	55.2	55.2	55.2	78.3	78.3		28.2	28.2		28.2	28.2	
Effective Green, g (s)	55.2	55.2	55.2	78.3	78.3		28.2	28.2		28.2	28.2	
Actuated g/C Ratio	0.46	0.46	0.46	0.65	0.65		0.23	0.23		0.23	0.23	
Clearance Time (s)	6.8	6.8	6.8	3.0	6.8		6.7	6.7		6.7	6.7	
Vehicle Extension (s)	3.0	3.0	3.0	3.0	3.0		3.0	3.0		3.0	3.0	
Lane Grp Cap (vph)	356	847	648	327	1196		170	351		214	436	
v/s Ratio Prot		0.43		c0.16	0.19			0.04			c0.13	
v/s Ratio Perm	0.01		0.10	c0.46			0.12			0.10		
v/c Ratio	0.01	0.93	0.22	0.94	0.30		0.52	0.19		0.42	0.53	
Uniform Delay, d1	17.6	30.5	19.5	37.9	9.0		40.0	36.7		38.9	40.1	
Progression Factor	1.00	1.00	1.00	1.09	0.78		0.95	1.26		1.00	1.00	
Incremental Delay, d2	0.0	15.7	0.2	33.5	0.1		11.0	1.2		5.9	4.6	
Delay (s)	17.6	46.2	19.7	75.0	7.2		49.2	47.6		44.8	44.7	
Level of Service	B	D	B	E	A		D	D		D	D	
Approach Delay (s)		41.2			38.6			48.1			44.8	
Approach LOS		D			D			D			D	

Intersection Summary

HCM 2000 Control Delay	41.8	HCM 2000 Level of Service	D
HCM 2000 Volume to Capacity ratio	0.85		
Actuated Cycle Length (s)	120.0	Sum of lost time (s)	16.5
Intersection Capacity Utilization	92.6%	ICU Level of Service	F
Analysis Period (min)	15		

c Critical Lane Group

Queues

Future Total (2033) -Optimized

3: Clarkway Drive/Humber Station Road & Mayfield Road

AM Peak Hour

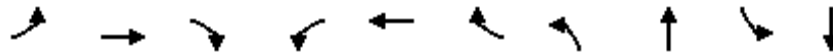

Lane Group	EBL	EBT	EBR	WBL	WBT	WBR	NBL	NBT	SBL	SBT
Lane Configurations	↶	↑↑↑	↷	↶	↑↑	↷	↶	↷	↶	↷
Traffic Volume (vph)	371	887	28	105	637	128	11	257	60	363
Future Volume (vph)	371	887	28	105	637	128	11	257	60	363
Lane Group Flow (vph)	386	924	29	109	664	133	11	496	63	511
Turn Type	pm+pt	NA	Perm	Perm	NA	Perm	Perm	NA	Perm	NA
Protected Phases	5	2			6			4		8
Permitted Phases	2		2	6		6	4		8	
Detector Phase	5	2	2	6	6	6	4	4	8	8
Switch Phase										
Minimum Initial (s)	5.0	12.0	12.0	12.0	12.0	12.0	8.0	8.0	8.0	8.0
Minimum Split (s)	9.5	27.3	27.3	27.5	27.5	27.5	26.0	26.0	27.5	27.5
Total Split (s)	20.0	70.0	70.0	50.0	50.0	50.0	50.0	50.0	50.0	50.0
Total Split (%)	16.7%	58.3%	58.3%	41.7%	41.7%	41.7%	41.7%	41.7%	41.7%	41.7%
Yellow Time (s)	3.0	4.6	4.6	4.6	4.6	4.6	4.2	4.2	4.2	4.2
All-Red Time (s)	0.0	2.7	2.7	2.7	2.7	2.7	2.8	2.8	2.8	2.8
Lost Time Adjust (s)	0.0	0.0	0.0	0.0	0.0	0.0	0.0	0.0	0.0	0.0
Total Lost Time (s)	3.0	7.3	7.3	7.3	7.3	7.3	7.0	7.0	7.0	7.0
Lead/Lag	Lead			Lag	Lag	Lag				
Lead-Lag Optimize?	Yes			Yes	Yes	Yes				
Recall Mode	None	C-Max	C-Max	C-Max	C-Max	C-Max	None	None	None	None
v/c Ratio	0.87	0.37	0.04	0.60	0.58	0.22	0.13	0.87	0.65	0.91
Control Delay	37.2	16.0	3.6	47.5	33.2	5.3	31.0	51.4	49.5	44.9
Queue Delay	0.0	0.0	0.0	0.0	0.0	0.0	0.0	0.0	0.0	0.0
Total Delay	37.2	16.0	3.6	47.5	33.2	5.3	31.0	51.4	49.5	44.9
Queue Length 50th (m)	51.8	46.9	0.0	22.2	70.6	0.0	1.9	104.1	11.6	128.7
Queue Length 95th (m)	#110.9	59.0	4.0	#49.2	91.1	13.4	6.8	#149.9	#36.5	#175.7
Internal Link Dist (m)		1635.6			190.4			1951.8		1542.4
Turn Bay Length (m)	150.0		105.0	150.0		115.0	75.0		105.0	
Base Capacity (vph)	446	2519	685	183	1146	609	92	622	107	615
Starvation Cap Reductn	0	0	0	0	0	0	0	0	0	0
Spillback Cap Reductn	0	0	0	0	0	0	0	0	0	0
Storage Cap Reductn	0	0	0	0	0	0	0	0	0	0
Reduced v/c Ratio	0.87	0.37	0.04	0.60	0.58	0.22	0.12	0.80	0.59	0.83

Intersection Summary





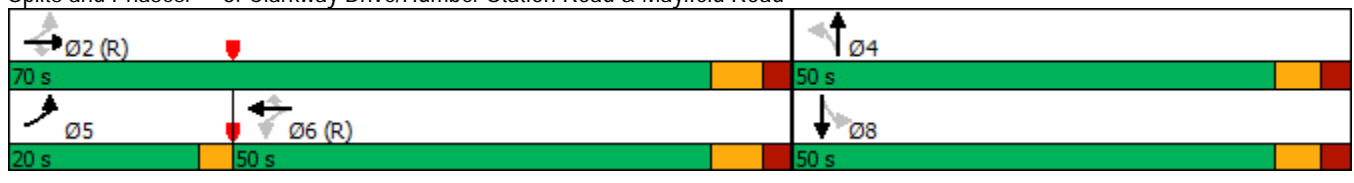























Cycle Length: 120
 Actuated Cycle Length: 120
 Offset: 0 (0%), Referenced to phase 2:EBTL and 6:WBTL, Start of Green
 Natural Cycle: 80
 Control Type: Actuated-Coordinated
 # 95th percentile volume exceeds capacity, queue may be longer.
 Queue shown is maximum after two cycles.

Splits and Phases: 3: Clarkway Drive/Humber Station Road & Mayfield Road



HCM Signalized Intersection Capacity Analysis
 3: Clarkway Drive/Humber Station Road & Mayfield Road

Future Total (2033) -Optimized
 AM Peak Hour

												
Movement	EBL	EBT	EBR	WBL	WBT	WBR	NBL	NBT	NBR	SBL	SBT	SBR
Lane Configurations		  			 			 				
Traffic Volume (vph)	371	887	28	105	637	128	11	257	219	60	363	128
Future Volume (vph)	371	887	28	105	637	128	11	257	219	60	363	128
Ideal Flow (vphpl)	1900	1900	1900	1900	1900	1900	1900	1900	1900	1900	1900	1900
Lane Width	3.0	3.5	3.0	3.0	3.5	3.0	3.0	3.5	3.0	3.0	3.5	3.0
Total Lost time (s)	3.0	7.3	7.3	7.3	7.3	7.3	7.0	7.0		7.0	7.0	
Lane Util. Factor	1.00	0.91	1.00	1.00	0.95	1.00	1.00	1.00		1.00	1.00	
Frt	1.00	1.00	0.85	1.00	1.00	0.85	1.00	0.93		1.00	0.96	
Flt Protected	0.95	1.00	1.00	0.95	1.00	1.00	0.95	1.00		0.95	1.00	
Satd. Flow (prot)	1560	4539	1206	1574	3077	1409	1428	1665		1504	1690	
Flt Permitted	0.28	1.00	1.00	0.30	1.00	1.00	0.17	1.00		0.19	1.00	
Satd. Flow (perm)	465	4539	1206	492	3077	1409	256	1665		299	1690	
Peak-hour factor, PHF	0.96	0.96	0.96	0.96	0.96	0.96	0.96	0.96	0.96	0.96	0.96	0.96
Adj. Flow (vph)	386	924	29	109	664	133	11	268	228	62	378	133
RTOR Reduction (vph)	0	0	13	0	0	83	0	27	0	0	11	0
Lane Group Flow (vph)	386	924	16	109	664	50	11	469	0	63	500	0
Heavy Vehicles (%)	8%	13%	25%	7%	16%	7%	18%	6%	4%	12%	4%	15%
Turn Type	pm+pt	NA	Perm	Perm	NA	Perm	Perm	NA		Perm	NA	
Protected Phases	5	2			6			4			8	
Permitted Phases	2		2	6		6	4			8		
Actuated Green, G (s)	66.6	66.6	66.6	44.7	44.7	44.7	39.1	39.1		39.1	39.1	
Effective Green, g (s)	66.6	66.6	66.6	44.7	44.7	44.7	39.1	39.1		39.1	39.1	
Actuated g/C Ratio	0.55	0.55	0.55	0.37	0.37	0.37	0.33	0.33		0.33	0.33	
Clearance Time (s)	3.0	7.3	7.3	7.3	7.3	7.3	7.0	7.0		7.0	7.0	
Vehicle Extension (s)	3.0	3.0	3.0	3.0	3.0	3.0	3.0	3.0		3.0	3.0	
Lane Grp Cap (vph)	430	2519	669	183	1146	524	83	542		97	550	
v/s Ratio Prot	c0.14	0.20			0.22			0.28			c0.30	
v/s Ratio Perm	c0.36		0.01	0.22		0.04	0.04			0.21		
v/c Ratio	0.90	0.37	0.02	0.60	0.58	0.09	0.13	0.87		0.65	0.91	
Uniform Delay, d1	17.7	14.9	12.0	30.4	30.1	24.5	28.5	38.0		34.6	38.8	
Progression Factor	1.00	1.00	1.00	1.00	1.00	1.00	1.00	1.00		0.56	0.63	
Incremental Delay, d2	20.8	0.4	0.1	13.5	2.1	0.4	0.7	13.5		13.6	18.4	
Delay (s)	38.6	15.3	12.1	43.9	32.3	24.8	29.2	51.5		32.9	42.8	
Level of Service	D	B	B	D	C	C	C	D		C	D	
Approach Delay (s)		22.0			32.6			51.0			41.7	
Approach LOS		C			C			D			D	
Intersection Summary												
HCM 2000 Control Delay			32.7			HCM 2000 Level of Service			C			
HCM 2000 Volume to Capacity ratio			0.92									
Actuated Cycle Length (s)			120.0			Sum of lost time (s)			17.3			
Intersection Capacity Utilization			92.8%			ICU Level of Service			F			
Analysis Period (min)			15									

c Critical Lane Group

Queues

Future Total (2033) -Optimized

4: Coleraine Drive & Mayfield Road

AM Peak Hour

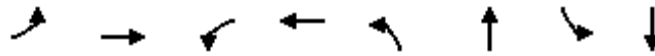

Lane Group	EBL	EBT	WBL	WBT	NBL	NBT	SBL	SBT
Lane Configurations	↖	↕	↗	↕	↖	↕	↗	↕
Traffic Volume (vph)	357	586	44	661	20	148	73	339
Future Volume (vph)	357	586	44	661	20	148	73	339
Lane Group Flow (vph)	406	723	50	808	23	178	83	645
Turn Type	pm+pt	NA	Perm	NA	Perm	NA	pm+pt	NA
Protected Phases	5	2		6		4	3	8
Permitted Phases	2		6		4		8	
Detector Phase	5	2	6	6	4	4	3	8
Switch Phase								
Minimum Initial (s)	5.0	12.0	12.0	12.0	12.0	12.0	5.0	12.0
Minimum Split (s)	8.0	37.0	37.0	37.0	37.0	37.0	8.0	37.0
Total Split (s)	15.0	80.0	65.0	65.0	32.0	32.0	18.0	50.0
Total Split (%)	11.5%	61.5%	50.0%	50.0%	24.6%	24.6%	13.8%	38.5%
Yellow Time (s)	3.0	4.6	4.6	4.6	4.2	4.2	3.0	4.2
All-Red Time (s)	0.0	2.4	2.4	2.4	2.8	2.8	0.0	2.8
Lost Time Adjust (s)	0.0	0.0	0.0	0.0	0.0	0.0	0.0	0.0
Total Lost Time (s)	3.0	7.0	7.0	7.0	7.0	7.0	3.0	7.0
Lead/Lag	Lead		Lag	Lag	Lag	Lag	Lead	
Lead-Lag Optimize?	Yes		Yes	Yes	Yes	Yes	Yes	
Recall Mode	None	C-Max	C-Max	C-Max	None	None	None	None
v/c Ratio	0.77	0.34	0.17	0.55	0.41	0.48	0.33	0.82
Control Delay	23.2	9.8	23.6	28.0	75.3	57.6	41.3	46.6
Queue Delay	0.0	0.0	0.0	0.0	0.0	0.0	0.0	0.0
Total Delay	23.2	9.8	23.6	28.0	75.3	57.6	41.3	46.6
Queue Length 50th (m)	38.3	38.0	7.9	81.9	6.0	23.8	18.2	71.3
Queue Length 95th (m)	#90.7	57.3	16.8	99.1	15.2	34.2	29.9	84.2
Internal Link Dist (m)		290.4		1003.7		791.2		576.8
Turn Bay Length (m)	100.0		85.0		105.0		145.0	
Base Capacity (vph)	528	2098	298	1462	103	680	272	1141
Starvation Cap Reductn	0	0	0	0	0	0	0	0
Spillback Cap Reductn	0	0	0	0	0	0	0	0
Storage Cap Reductn	0	0	0	0	0	0	0	0
Reduced v/c Ratio	0.77	0.34	0.17	0.55	0.22	0.26	0.31	0.57

Intersection Summary





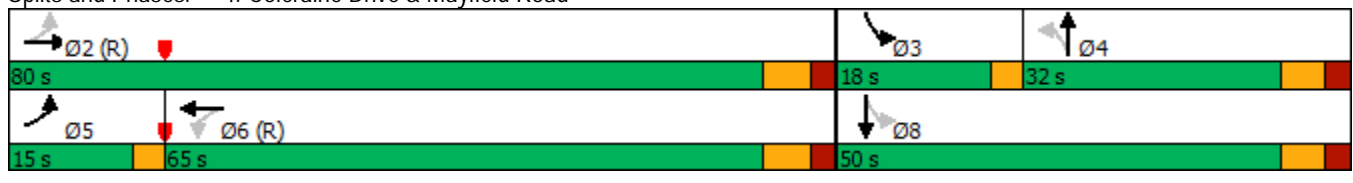















Cycle Length: 130
 Actuated Cycle Length: 130
 Offset: 92 (71%), Referenced to phase 2:EBTL and 6:WBTL, Start of Green
 Natural Cycle: 100
 Control Type: Actuated-Coordinated
 # 95th percentile volume exceeds capacity, queue may be longer.
 Queue shown is maximum after two cycles.

Splits and Phases: 4: Coleraine Drive & Mayfield Road



HCM Signalized Intersection Capacity Analysis
4: Coleraine Drive & Mayfield Road

Future Total (2033) -Optimized
AM Peak Hour

												
Movement	EBL	EBT	EBR	WBL	WBT	WBR	NBL	NBT	NBR	SBL	SBT	SBR
Lane Configurations												
Traffic Volume (vph)	357	586	50	44	661	50	20	148	9	73	339	229
Future Volume (vph)	357	586	50	44	661	50	20	148	9	73	339	229
Ideal Flow (vphpl)	1900	1900	1900	1900	1900	1900	1900	1900	1900	1900	1900	1900
Lane Width	3.0	3.5	3.0	3.0	3.5	3.0	3.0	3.5	3.0	3.0	3.5	3.0
Total Lost time (s)	3.0	7.0		7.0	7.0		7.0	7.0		3.0	7.0	
Lane Util. Factor	1.00	0.95		1.00	0.95		1.00	0.95		1.00	0.95	
Fr't	1.00	0.99		1.00	0.99		1.00	0.99		1.00	0.94	
Fl't Protected	0.95	1.00		0.95	1.00		0.95	1.00		0.95	1.00	
Satd. Flow (prot)	1574	3095		1685	3269		1532	3518		1452	3175	
Fl't Permitted	0.24	1.00		0.38	1.00		0.34	1.00		0.52	1.00	
Satd. Flow (perm)	402	3095		668	3269		541	3518		802	3175	
Peak-hour factor, PHF	0.88	0.88	0.88	0.88	0.88	0.88	0.88	0.88	0.88	0.88	0.88	0.88
Adj. Flow (vph)	406	666	57	50	751	57	23	168	10	83	385	260
RTOR Reduction (vph)	0	4	0	0	4	0	0	4	0	0	107	0
Lane Group Flow (vph)	406	719	0	50	804	0	23	174	0	83	538	0
Heavy Vehicles (%)	7%	15%	2%	0%	7%	22%	10%	0%	11%	16%	0%	14%
Turn Type	pm+pt	NA		Perm	NA		Perm	NA		pm+pt	NA	
Protected Phases	5	2			6			4		3	8	
Permitted Phases	2			6			4			8		
Actuated Green, G (s)	88.0	88.0		58.0	58.0		13.7	13.7		28.0	28.0	
Effective Green, g (s)	88.0	88.0		58.0	58.0		13.7	13.7		28.0	28.0	
Actuated g/C Ratio	0.68	0.68		0.45	0.45		0.11	0.11		0.22	0.22	
Clearance Time (s)	3.0	7.0		7.0	7.0		7.0	7.0		3.0	7.0	
Vehicle Extension (s)	3.0	3.0		3.0	3.0		3.0	3.0		3.0	3.0	
Lane Grp Cap (vph)	515	2095		298	1458		57	370		229	683	
v/s Ratio Prot	c0.16	0.23			0.25			0.05		0.03	c0.17	
v/s Ratio Perm	c0.37			0.07			0.04			0.05		
v/c Ratio	0.79	0.34		0.17	0.55		0.40	0.47		0.36	0.79	
Uniform Delay, d1	13.8	8.8		21.6	26.4		54.3	54.7		42.5	48.2	
Progression Factor	1.00	1.00		1.00	1.00		1.00	1.00		1.00	1.00	
Incremental Delay, d2	7.8	0.4		1.2	1.5		4.6	1.0		1.0	6.0	
Delay (s)	21.6	9.3		22.8	27.9		59.0	55.7		43.5	54.2	
Level of Service	C	A		C	C		E	E		D	D	
Approach Delay (s)		13.7			27.6			56.1			53.0	
Approach LOS		B			C			E			D	
Intersection Summary												
HCM 2000 Control Delay			30.5									C
HCM 2000 Volume to Capacity ratio			0.83									
Actuated Cycle Length (s)			130.0								20.0	
Intersection Capacity Utilization			87.2%									E
Analysis Period (min)			15									
c	Critical Lane Group											

Queues

Future Total (2033) -Optimized

5: Coleraine Drive & Private Access/George Bolton Parkway

AM Peak Hour



Lane Group	EBL	EBT	WBL	WBT	NBL	NBT	SBL	SBT	SBR
Lane Configurations	↖	↗	↖	↗	↖	↗	↖	↗	↗
Traffic Volume (vph)	4	12	63	23	30	412	117	499	11
Future Volume (vph)	4	12	63	23	30	412	117	499	11
Lane Group Flow (vph)	5	29	73	196	35	591	136	580	13
Turn Type	Perm	NA	Perm	NA	Perm	NA	Perm	NA	Perm
Protected Phases		8		4		6		2	
Permitted Phases	8		4		6		2		2
Detector Phase	8	8	4	4	6	6	2	2	2
Switch Phase									
Minimum Initial (s)	8.0	8.0	12.0	12.0	12.0	12.0	12.0	12.0	12.0
Minimum Split (s)	32.5	32.5	32.5	32.5	34.2	34.2	33.7	33.7	33.7
Total Split (s)	45.0	45.0	45.0	45.0	55.0	55.0	55.0	55.0	55.0
Total Split (%)	45.0%	45.0%	45.0%	45.0%	55.0%	55.0%	55.0%	55.0%	55.0%
Yellow Time (s)	4.0	4.0	4.0	4.0	4.2	4.2	4.2	4.2	4.2
All-Red Time (s)	3.5	3.5	3.5	3.5	2.5	2.5	2.5	2.5	2.5
Lost Time Adjust (s)	0.0	0.0	0.0	0.0	0.0	0.0	0.0	0.0	0.0
Total Lost Time (s)	7.5	7.5	7.5	7.5	6.7	6.7	6.7	6.7	6.7
Lead/Lag									
Lead-Lag Optimize?									
Recall Mode	None	None	None	None	C-Max	C-Max	C-Max	C-Max	C-Max
v/c Ratio	0.04	0.15	0.52	0.56	0.08	0.27	0.27	0.26	0.01
Control Delay	35.2	24.0	52.1	15.1	5.6	5.4	7.4	5.7	0.0
Queue Delay	0.0	0.0	0.0	0.0	0.0	0.0	0.0	0.0	0.0
Total Delay	35.2	24.0	52.1	15.1	5.6	5.4	7.4	5.7	0.0
Queue Length 50th (m)	0.9	2.6	14.2	5.0	1.7	16.5	7.9	17.4	0.0
Queue Length 95th (m)	3.9	9.7	25.9	21.6	5.7	28.5	19.4	29.6	0.0
Internal Link Dist (m)		152.4		468.8		784.9		1711.9	
Turn Bay Length (m)	70.0		105.0		75.0		100.0		100.0
Base Capacity (vph)	335	486	369	641	446	2166	498	2235	1001
Starvation Cap Reductn	0	0	0	0	0	0	0	0	0
Spillback Cap Reductn	0	0	0	0	0	0	0	0	0
Storage Cap Reductn	0	0	0	0	0	0	0	0	0
Reduced v/c Ratio	0.01	0.06	0.20	0.31	0.08	0.27	0.27	0.26	0.01

Intersection Summary

Cycle Length: 100
 Actuated Cycle Length: 100
 Offset: 0 (0%), Referenced to phase 2:SBTL and 6:NBTL, Start of Green
 Natural Cycle: 70
 Control Type: Actuated-Coordinated

Splits and Phases: 5: Coleraine Drive & Private Access/George Bolton Parkway

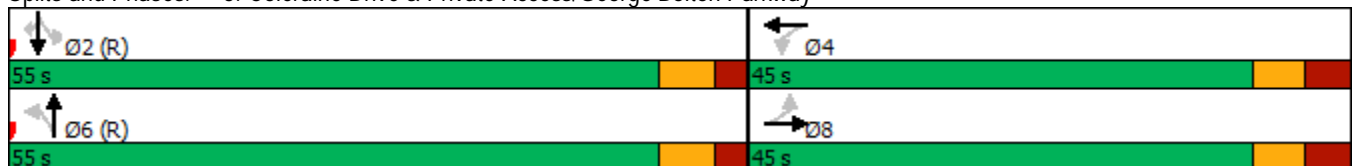

HCM Signalized Intersection Capacity Analysis

Future Total (2033) -Optimized

5: Coleraine Drive & Private Access/George Bolton Parkway

AM Peak Hour



Movement	EBL	EBT	EBR	WBL	WBT	WBR	NBL	NBT	NBR	SBL	SBT	SBR
Lane Configurations	↖	↗		↖	↗		↖	↕		↖	↗	↗
Traffic Volume (vph)	4	12	13	63	23	145	30	412	96	117	499	11
Future Volume (vph)	4	12	13	63	23	145	30	412	96	117	499	11
Ideal Flow (vphpl)	1900	1900	1900	1900	1900	1900	1900	1900	1900	1900	1900	1900
Lane Width	3.0	3.5	3.0	3.0	3.5	3.0	3.0	3.5	3.0	3.0	3.5	3.0
Total Lost time (s)	7.5	7.5		7.5	7.5		6.7	6.7		6.7	6.7	6.7
Lane Util. Factor	1.00	1.00		1.00	1.00		1.00	0.95		1.00	0.95	1.00
Fr _t	1.00	0.92		1.00	0.87		1.00	0.97		1.00	1.00	0.85
Fl _t Protected	0.95	1.00		0.95	1.00		0.95	1.00		0.95	1.00	1.00
Satd. Flow (prot)	1685	1271		1267	1428		1370	3017		1546	3131	1383
Fl _t Permitted	0.50	1.00		0.74	1.00		0.43	1.00		0.43	1.00	1.00
Satd. Flow (perm)	894	1271		984	1428		625	3017		698	3131	1383
Peak-hour factor, PHF	0.86	0.86	0.86	0.86	0.86	0.86	0.86	0.86	0.86	0.86	0.86	0.86
Adj. Flow (vph)	5	14	15	73	27	169	35	479	112	136	580	13
RTOR Reduction (vph)	0	13	0	0	145	0	0	11	0	0	0	4
Lane Group Flow (vph)	5	16	0	73	51	0	35	580	0	136	580	9
Heavy Vehicles (%)	0%	42%	31%	33%	43%	10%	23%	14%	19%	9%	14%	9%
Turn Type	Perm	NA		Perm	NA		Perm	NA		Perm	NA	Perm
Protected Phases		8			4			6			2	
Permitted Phases	8			4			6			2		2
Actuated Green, G (s)	14.4	14.4		14.4	14.4		71.4	71.4		71.4	71.4	71.4
Effective Green, g (s)	14.4	14.4		14.4	14.4		71.4	71.4		71.4	71.4	71.4
Actuated g/C Ratio	0.14	0.14		0.14	0.14		0.71	0.71		0.71	0.71	0.71
Clearance Time (s)	7.5	7.5		7.5	7.5		6.7	6.7		6.7	6.7	6.7
Vehicle Extension (s)	3.0	3.0		3.0	3.0		3.0	3.0		3.0	3.0	3.0
Lane Grp Cap (vph)	128	183		141	205		446	2154		498	2235	987
v/s Ratio Prot		0.01			0.04			0.19			0.19	
v/s Ratio Perm	0.01			c0.07			0.06			c0.19		0.01
v/c Ratio	0.04	0.09		0.52	0.25		0.08	0.27		0.27	0.26	0.01
Uniform Delay, d ₁	36.8	37.1		39.6	38.0		4.3	5.1		5.1	5.0	4.1
Progression Factor	1.00	1.00		1.00	1.00		1.00	1.00		1.00	1.00	1.00
Incremental Delay, d ₂	0.1	0.2		3.2	0.6		0.3	0.3		1.4	0.3	0.0
Delay (s)	37.0	37.3		42.8	38.7		4.7	5.4		6.4	5.3	4.1
Level of Service	D	D		D	D		A	A		A	A	A
Approach Delay (s)		37.3			39.8			5.3			5.5	
Approach LOS		D			D			A			A	

Intersection Summary

HCM 2000 Control Delay	11.6	HCM 2000 Level of Service	B
HCM 2000 Volume to Capacity ratio	0.31		
Actuated Cycle Length (s)	100.0	Sum of lost time (s)	14.2
Intersection Capacity Utilization	52.0%	ICU Level of Service	A
Analysis Period (min)	15		

c Critical Lane Group

Queues
6: Highway 50 & George Bolton Parkway/Private Access

Future Total (2033) -Optimized
AM Peak Hour



Lane Group	EBL	EBT	WBT	NBL	NBT	SBL	SBT	SBR
Lane Configurations								
Traffic Volume (vph)	93	0	0	165	933	3	1144	138
Future Volume (vph)	93	0	0	165	933	3	1144	138
Lane Group Flow (vph)	97	125	1	172	972	3	1192	144
Turn Type	Perm	NA	NA	pm+pt	NA	Perm	NA	Perm
Protected Phases		8	4	1	6		2	
Permitted Phases	8			6		2		2
Detector Phase	8	8	4	1	6	2	2	2
Switch Phase								
Minimum Initial (s)	8.0	8.0	8.0	5.0	12.0	12.0	12.0	12.0
Minimum Split (s)	32.6	32.6	32.6	8.0	27.3	27.3	27.3	27.3
Total Split (s)	35.0	35.0	35.0	10.0	85.0	75.0	75.0	75.0
Total Split (%)	29.2%	29.2%	29.2%	8.3%	70.8%	62.5%	62.5%	62.5%
Yellow Time (s)	4.0	4.0	4.0	3.0	4.0	4.0	4.0	4.0
All-Red Time (s)	2.6	2.6	2.6	0.0	2.3	2.3	2.3	2.3
Lost Time Adjust (s)	0.0	0.0	0.0	0.0	0.0	0.0	0.0	0.0
Total Lost Time (s)	6.6	6.6	6.6	3.0	6.3	6.3	6.3	6.3
Lead/Lag				Lead		Lag	Lag	Lag
Lead-Lag Optimize?				Yes		Yes	Yes	Yes
Recall Mode	None	None	None	None	C-Max	C-Max	C-Max	C-Max
v/c Ratio	0.65	0.43	0.00	0.56	0.37	0.01	0.55	0.14
Control Delay	68.8	7.4	0.0	10.6	5.5	10.0	13.3	2.4
Queue Delay	0.0	0.0	0.0	0.0	0.0	0.0	0.0	0.0
Total Delay	68.8	7.4	0.0	10.6	5.5	10.0	13.3	2.4
Queue Length 50th (m)	23.2	0.0	0.0	8.1	34.8	0.2	76.0	0.6
Queue Length 95th (m)	39.7	8.7	0.0	18.1	56.7	1.8	121.4	9.7
Internal Link Dist (m)		846.5	43.0		1045.6		1307.8	
Turn Bay Length (m)	85.0			40.0		135.0		60.0
Base Capacity (vph)	283	405	502	308	2609	343	2173	999
Starvation Cap Reductn	0	0	0	0	0	0	0	0
Spillback Cap Reductn	0	0	0	0	0	0	0	0
Storage Cap Reductn	0	0	0	0	0	0	0	0
Reduced v/c Ratio	0.34	0.31	0.00	0.56	0.37	0.01	0.55	0.14

Intersection Summary





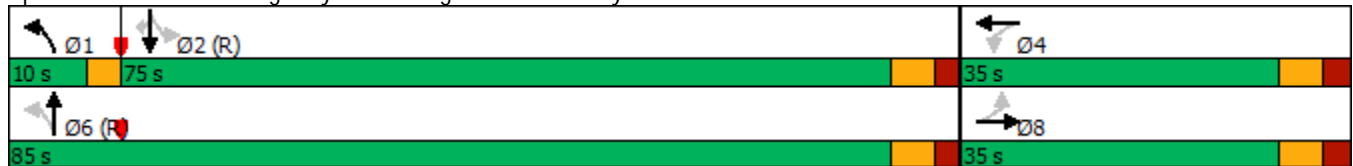















Cycle Length: 120
 Actuated Cycle Length: 120
 Offset: 113 (94%), Referenced to phase 2:SBTL and 6:NBTL, Start of Green
 Natural Cycle: 80
 Control Type: Actuated-Coordinated

Splits and Phases: 6: Highway 50 & George Bolton Parkway/Private Access



HCM Signalized Intersection Capacity Analysis
6: Highway 50 & George Bolton Parkway/Private Access

Future Total (2033) -Optimized
AM Peak Hour













													
Movement	EBL	EBT	EBR	WBL	WBT	WBR	NBL	NBT	NBR	SBL	SBT	SBR	
Lane Configurations													
Traffic Volume (vph)	93	0	120	0	0	1	165	933	0	3	1144	138	
Future Volume (vph)	93	0	120	0	0	1	165	933	0	3	1144	138	
Ideal Flow (vphpl)	1900	1900	1900	1900	1900	1900	1900	1900	1900	1900	1900	1900	
Lane Width	3.0	3.5	3.0	3.0	3.5	3.0	3.0	3.5	3.0	3.0	3.5	3.0	
Total Lost time (s)	6.6	6.6			6.6		3.0	6.3		6.3	6.3	6.3	
Lane Util. Factor	1.00	1.00			1.00		1.00	0.95		1.00	0.95	1.00	
Frt	1.00	0.85			0.86		1.00	1.00		1.00	1.00	0.85	
Flt Protected	0.95	1.00			1.00		0.95	1.00		0.95	1.00	1.00	
Satd. Flow (prot)	1504	1192			1625		1392	3400		1685	3305	1449	
Flt Permitted	0.76	1.00			1.00		0.18	1.00		0.29	1.00	1.00	
Satd. Flow (perm)	1199	1192			1625		268	3400		523	3305	1449	
Peak-hour factor, PHF	0.96	0.96	0.96	0.96	0.96	0.96	0.96	0.96	0.96	0.96	0.96	0.96	
Adj. Flow (vph)	97	0	125	0	0	1	172	972	0	3	1192	144	
RTOR Reduction (vph)	0	109	0	0	1	0	0	0	0	0	0	47	
Lane Group Flow (vph)	97	16	0	0	0	0	172	972	0	3	1192	97	
Heavy Vehicles (%)	12%	0%	34%	0%	0%	0%	21%	5%	0%	0%	8%	4%	
Turn Type	Perm	NA			NA		pm+pt	NA		Perm	NA	Perm	
Protected Phases		8			4		1	6			2		
Permitted Phases	8			4			6			2		2	
Actuated Green, G (s)	15.0	15.0			15.0		92.1	92.1		78.9	78.9	78.9	
Effective Green, g (s)	15.0	15.0			15.0		92.1	92.1		78.9	78.9	78.9	
Actuated g/C Ratio	0.12	0.12			0.12		0.77	0.77		0.66	0.66	0.66	
Clearance Time (s)	6.6	6.6			6.6		3.0	6.3		6.3	6.3	6.3	
Vehicle Extension (s)	3.0	3.0			3.0		3.0	3.0		3.0	3.0	3.0	
Lane Grp Cap (vph)	149	149			203		301	2609		343	2173	952	
v/s Ratio Prot		0.01			0.00		c0.05	0.29			0.36		
v/s Ratio Perm	c0.08						c0.39			0.01		0.07	
v/c Ratio	0.65	0.10			0.00		0.57	0.37		0.01	0.55	0.10	
Uniform Delay, d1	50.0	46.5			45.9		6.6	4.5		7.1	11.0	7.5	
Progression Factor	1.00	1.00			1.00		1.00	1.00		1.00	1.00	1.00	
Incremental Delay, d2	9.8	0.3			0.0		2.6	0.4		0.0	1.0	0.2	
Delay (s)	59.8	46.9			45.9		9.2	5.0		7.1	12.0	7.8	
Level of Service	E	D			D		A	A		A	B	A	
Approach Delay (s)		52.5			45.9			5.6			11.5		
Approach LOS		D			D			A			B		

Intersection Summary		
HCM 2000 Control Delay	12.4	HCM 2000 Level of Service
HCM 2000 Volume to Capacity ratio	0.60	B
Actuated Cycle Length (s)	120.0	Sum of lost time (s)
Intersection Capacity Utilization	66.7%	15.9
Analysis Period (min)	15	ICU Level of Service
		C

c Critical Lane Group

Queues
 9: Humber Station Road & Subject Lands Site Access #1

Future Total (2033) -Optimized
 AM Peak Hour

						
Lane Group	WBL	WBR	NBT	NBR	SBL	SBT
Lane Configurations						
Traffic Volume (vph)	179	110	251	505	285	372
Future Volume (vph)	179	110	251	505	285	372
Lane Group Flow (vph)	179	110	251	505	285	372
Turn Type	Prot	Perm	NA	Perm	Perm	NA
Protected Phases	8		2			6
Permitted Phases		8		2	6	
Detector Phase	8	8	2	2	6	6
Switch Phase						
Minimum Initial (s)	12.0	12.0	12.0	12.0	12.0	12.0
Minimum Split (s)	25.5	25.5	24.7	24.7	24.7	24.7
Total Split (s)	45.0	45.0	75.0	75.0	75.0	75.0
Total Split (%)	37.5%	37.5%	62.5%	62.5%	62.5%	62.5%
Yellow Time (s)	4.0	4.0	4.2	4.2	4.2	4.2
All-Red Time (s)	3.5	3.5	2.5	2.5	2.5	2.5
Lost Time Adjust (s)	0.0	0.0	0.0	0.0	0.0	0.0
Total Lost Time (s)	7.5	7.5	6.7	6.7	6.7	6.7
Lead/Lag						
Lead-Lag Optimize?						
Recall Mode	None	None	C-Max	C-Max	C-Max	C-Max
v/c Ratio	0.73	0.35	0.20	0.44	0.40	0.29
Control Delay	64.1	10.4	5.5	1.2	16.4	12.2
Queue Delay	0.0	0.0	0.0	0.0	0.0	0.0
Total Delay	64.1	10.4	5.5	1.2	16.4	12.2
Queue Length 50th (m)	42.6	0.0	12.0	0.0	48.9	53.9
Queue Length 95th (m)	63.5	15.0	m25.2	m0.0	m80.8	m89.2
Internal Link Dist (m)	321.1		1542.4			467.1
Turn Bay Length (m)	100.0			30.0	100.0	
Base Capacity (vph)	453	481	1264	1149	712	1301
Starvation Cap Reductn	0	0	0	0	0	0
Spillback Cap Reductn	0	0	0	0	0	0
Storage Cap Reductn	0	0	0	0	0	0
Reduced v/c Ratio	0.40	0.23	0.20	0.44	0.40	0.29

Intersection Summary





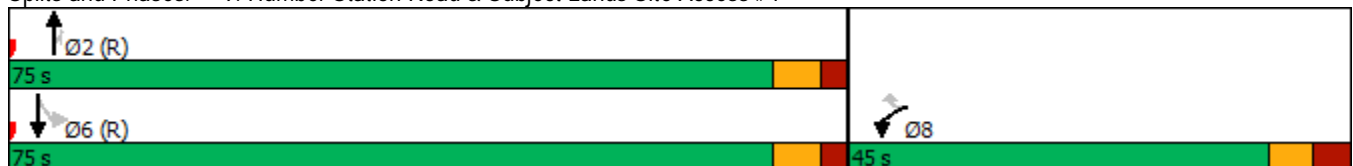







Cycle Length: 120
 Actuated Cycle Length: 120
 Offset: 0 (0%), Referenced to phase 2:NBT and 6:SBTL, Start of Green
 Natural Cycle: 60
 Control Type: Actuated-Coordinated
 m Volume for 95th percentile queue is metered by upstream signal.

Splits and Phases: 9: Humber Station Road & Subject Lands Site Access #1



HCM Signalized Intersection Capacity Analysis
 9: Humber Station Road & Subject Lands Site Access #1

Future Total (2033) -Optimized
 AM Peak Hour

						
Movement	WBL	WBR	NBT	NBR	SBL	SBT
Lane Configurations						
Traffic Volume (vph)	179	110	251	505	285	372
Future Volume (vph)	179	110	251	505	285	372
Ideal Flow (vphpl)	1900	1900	1900	1900	1900	1900
Lane Width	3.0	3.0	3.5	3.0	3.0	3.5
Total Lost time (s)	7.5	7.5	6.7	6.7	6.7	6.7
Lane Util. Factor	1.00	1.00	1.00	1.00	1.00	1.00
Frt	1.00	0.85	1.00	0.85	1.00	1.00
Flt Protected	0.95	1.00	1.00	1.00	0.95	1.00
Satd. Flow (prot)	1452	1299	1773	1409	1574	1824
Flt Permitted	0.95	1.00	1.00	1.00	0.60	1.00
Satd. Flow (perm)	1452	1299	1773	1409	1000	1824
Peak-hour factor, PHF	1.00	1.00	1.00	1.00	1.00	1.00
Adj. Flow (vph)	179	110	251	505	285	372
RTOR Reduction (vph)	0	91	0	145	0	0
Lane Group Flow (vph)	179	19	251	360	285	372
Heavy Vehicles (%)	16%	16%	6%	7%	7%	3%
Turn Type	Prot	Perm	NA	Perm	Perm	NA
Protected Phases	8		2			6
Permitted Phases		8		2	6	
Actuated Green, G (s)	20.2	20.2	85.6	85.6	85.6	85.6
Effective Green, g (s)	20.2	20.2	85.6	85.6	85.6	85.6
Actuated g/C Ratio	0.17	0.17	0.71	0.71	0.71	0.71
Clearance Time (s)	7.5	7.5	6.7	6.7	6.7	6.7
Vehicle Extension (s)	3.0	3.0	3.0	3.0	3.0	3.0
Lane Grp Cap (vph)	244	218	1264	1005	713	1301
v/s Ratio Prot	c0.12		0.14			0.20
v/s Ratio Perm		0.01		0.26	c0.28	
v/c Ratio	0.73	0.08	0.20	0.36	0.40	0.29
Uniform Delay, d1	47.3	42.1	5.7	6.6	6.9	6.2
Progression Factor	1.00	1.00	0.80	0.58	1.81	1.67
Incremental Delay, d2	10.8	0.2	0.2	0.7	1.4	0.5
Delay (s)	58.2	42.3	4.8	4.5	13.9	10.8
Level of Service	E	D	A	A	B	B
Approach Delay (s)	52.1		4.6			12.1
Approach LOS	D		A			B

Intersection Summary

HCM 2000 Control Delay	15.6	HCM 2000 Level of Service	B
HCM 2000 Volume to Capacity ratio	0.46		
Actuated Cycle Length (s)	120.0	Sum of lost time (s)	14.2
Intersection Capacity Utilization	58.2%	ICU Level of Service	B
Analysis Period (min)	15		

c Critical Lane Group

HCM Unsignalized Intersection Capacity Analysis
 24: Mayfield Road & Triangle Lands













Future Total (2033) -Optimized
 AM Peak Hour



Movement	EBL	EBT	WBT	WBR	SBL	SBR	
Lane Configurations							
Traffic Volume (veh/h)	160	986	800	108	33	72	
Future Volume (Veh/h)	160	986	800	108	33	72	
Sign Control		Free	Free		Stop		
Grade		0%	0%		0%		
Peak Hour Factor	1.00	1.00	1.00	1.00	1.00	1.00	
Hourly flow rate (vph)	160	986	800	108	33	72	
Pedestrians							
Lane Width (m)							
Walking Speed (m/s)							
Percent Blockage							
Right turn flare (veh)							
Median type		None	None				
Median storage veh							
Upstream signal (m)			314				
pX, platoon unblocked	0.85				0.85	0.85	
vC, conflicting volume	908				1667	454	
vC1, stage 1 conf vol							
vC2, stage 2 conf vol							
vCu, unblocked vol	537				1431	3	
tC, single (s)	4.2				7.0	7.2	
tC, 2 stage (s)							
tF (s)	2.3				3.6	3.4	
p0 queue free %	81				58	92	
cM capacity (veh/h)	844				79	888	
Direction, Lane #	EB 1	EB 2	EB 3	WB 1	WB 2	SB 1	SB 2
Volume Total	160	493	493	533	375	33	72
Volume Left	160	0	0	0	0	33	0
Volume Right	0	0	0	0	108	0	72
cSH	844	1700	1700	1700	1700	79	888
Volume to Capacity	0.19	0.29	0.29	0.31	0.22	0.42	0.08
Queue Length 95th (m)	5.6	0.0	0.0	0.0	0.0	13.4	2.1
Control Delay (s)	10.3	0.0	0.0	0.0	0.0	80.4	9.4
Lane LOS	B					F	A
Approach Delay (s)	1.4			0.0		31.7	
Approach LOS						D	
Intersection Summary							
Average Delay			2.3				
Intersection Capacity Utilization			47.8%		ICU Level of Service		A
Analysis Period (min)			15				

HCM Unsignalized Intersection Capacity Analysis
 26: Humber Station Road & Subject Lands Site Access #3

Future Total (2033) -Optimized
 AM Peak Hour

						
Movement	WBL	WBR	NBT	NBR	SBL	SBT
Lane Configurations						
Traffic Volume (veh/h)	38	24	254	100	57	620
Future Volume (Veh/h)	38	24	254	100	57	620
Sign Control	Stop		Free		Free	
Grade	0%		0%		0%	
Peak Hour Factor	1.00	1.00	1.00	1.00	1.00	1.00
Hourly flow rate (vph)	38	24	254	100	57	620
Pedestrians						
Lane Width (m)						
Walking Speed (m/s)						
Percent Blockage						
Right turn flare (veh)						
Median type	None			None		
Median storage veh						
Upstream signal (m)						
pX, platoon unblocked						
vC, conflicting volume	988	254			354	
vC1, stage 1 conf vol						
vC2, stage 2 conf vol						
vCu, unblocked vol	988	254			354	
tC, single (s)	6.5	6.3			4.2	
tC, 2 stage (s)						
tF (s)	3.6	3.4			2.3	
p0 queue free %	85	97			95	
cM capacity (veh/h)	249	759			1178	
Direction, Lane #	WB 1	WB 2	NB 1	NB 2	SB 1	SB 2
Volume Total	38	24	254	100	57	620
Volume Left	38	0	0	0	57	0
Volume Right	0	24	0	100	0	0
cSH	249	759	1700	1700	1178	1700
Volume to Capacity	0.15	0.03	0.15	0.06	0.05	0.36
Queue Length 95th (m)	4.2	0.8	0.0	0.0	1.2	0.0
Control Delay (s)	22.1	9.9	0.0	0.0	8.2	0.0
Lane LOS	C	A			A	
Approach Delay (s)	17.4	0.0		0.7		
Approach LOS	C					
Intersection Summary						
Average Delay			1.4			
Intersection Capacity Utilization			42.6%	ICU Level of Service	A	
Analysis Period (min)			15			

HCM Unsignalized Intersection Capacity Analysis
 27: Subject Lands Site Access #4 & Healey Road













Future Total (2033) -Optimized
 AM Peak Hour



Movement	EBT	EBR	WBL	WBT	NBL	NBR
Lane Configurations	↩			↩	↩	↩
Traffic Volume (veh/h)	903	79	72	588	32	27
Future Volume (Veh/h)	903	79	72	588	32	27
Sign Control	Free			Free	Stop	
Grade	0%			0%	0%	
Peak Hour Factor	1.00	1.00	1.00	1.00	1.00	1.00
Hourly flow rate (vph)	903	79	72	588	32	27
Pedestrians						
Lane Width (m)						
Walking Speed (m/s)						
Percent Blockage						
Right turn flare (veh)						
Median type	None			None		
Median storage veh						
Upstream signal (m)						
pX, platoon unblocked						
vC, conflicting volume			982		1674	942
vC1, stage 1 conf vol						
vC2, stage 2 conf vol						
vCu, unblocked vol			982		1674	942
tC, single (s)			4.2		6.5	6.3
tC, 2 stage (s)						
tF (s)			2.3		3.6	3.4
p0 queue free %			89		64	91
cM capacity (veh/h)			684		88	307
Direction, Lane #	EB 1	WB 1	NB 1	NB 2		
Volume Total	982	660	32	27		
Volume Left	0	72	32	0		
Volume Right	79	0	0	27		
cSH	1700	684	88	307		
Volume to Capacity	0.58	0.11	0.36	0.09		
Queue Length 95th (m)	0.0	2.8	11.4	2.3		
Control Delay (s)	0.0	2.7	67.4	17.9		
Lane LOS		A	F	C		
Approach Delay (s)	0.0	2.7	44.7			
Approach LOS			E			
Intersection Summary						
Average Delay			2.6			
Intersection Capacity Utilization			100.6%	ICU Level of Service	G	
Analysis Period (min)			15			

HCM Unsignalized Intersection Capacity Analysis
 28: Humber Station Road & Subject Lands Site Access #2

Future Total (2033) -Optimized
 AM Peak Hour

						
Movement	WBL	WBR	NBT	NBR	SBL	SBT
Lane Configurations						
Traffic Volume (veh/h)	3	2	352	9	4	654
Future Volume (Veh/h)	3	2	352	9	4	654
Sign Control	Stop		Free		Free	
Grade	0%		0%		0%	
Peak Hour Factor	1.00	1.00	1.00	1.00	1.00	1.00
Hourly flow rate (vph)	3	2	352	9	4	654
Pedestrians						
Lane Width (m)						
Walking Speed (m/s)						
Percent Blockage						
Right turn flare (veh)						
Median type	None			None		
Median storage (veh)						
Upstream signal (m)						
pX, platoon unblocked						
vC, conflicting volume	1014	352			361	
vC1, stage 1 conf vol						
vC2, stage 2 conf vol						
vCu, unblocked vol	1014	352			361	
tC, single (s)	6.7	6.2			4.1	
tC, 2 stage (s)						
tF (s)	3.8	3.3			2.2	
p0 queue free %	99	100			100	
cM capacity (veh/h)	231	696			1209	
Direction, Lane #	WB 1	WB 2	NB 1	NB 2	SB 1	SB 2
Volume Total	3	2	352	9	4	654
Volume Left	3	0	0	0	4	0
Volume Right	0	2	0	9	0	0
cSH	231	696	1700	1700	1209	1700
Volume to Capacity	0.01	0.00	0.21	0.01	0.00	0.38
Queue Length 95th (m)	0.3	0.1	0.0	0.0	0.1	0.0
Control Delay (s)	20.8	10.2	0.0	0.0	8.0	0.0
Lane LOS	C	B			A	
Approach Delay (s)	16.5		0.0	0.0		
Approach LOS	C					
Intersection Summary						
Average Delay			0.1			
Intersection Capacity Utilization			44.4%	ICU Level of Service		A
Analysis Period (min)	15					

HCM Unsignalized Intersection Capacity Analysis
 29: Mayfield Road & Subject Lands Site Access #5

Future Total (2033) -Optimized
 AM Peak Hour

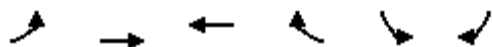

Movement	EBL	EBT	WBT	WBR	SBL	SBR	
Lane Configurations	↖	↑↑	↑↑		↙	↘	
Traffic Volume (veh/h)	25	1141	860	12	5	10	
Future Volume (Veh/h)	25	1141	860	12	5	10	
Sign Control		Free	Free		Stop		
Grade		0%	0%		0%		
Peak Hour Factor	1.00	1.00	1.00	1.00	1.00	1.00	
Hourly flow rate (vph)	25	1141	860	12	5	10	
Pedestrians							
Lane Width (m)							
Walking Speed (m/s)							
Percent Blockage							
Right turn flare (veh)							
Median type		None	None				
Median storage veh							
Upstream signal (m)		262					
pX, platoon unblocked					0.87		
vC, conflicting volume	872				1486	436	
vC1, stage 1 conf vol							
vC2, stage 2 conf vol							
vCu, unblocked vol	872				1267	436	
tC, single (s)	4.1				6.8	6.9	
tC, 2 stage (s)							
tF (s)	2.2				3.5	3.3	
p0 queue free %	97				96	98	
cM capacity (veh/h)	782				138	574	
Direction, Lane #	EB 1	EB 2	EB 3	WB 1	WB 2	SB 1	SB 2
Volume Total	25	570	570	573	299	5	10
Volume Left	25	0	0	0	0	5	0
Volume Right	0	0	0	0	12	0	10
cSH	782	1700	1700	1700	1700	138	574
Volume to Capacity	0.03	0.34	0.34	0.34	0.18	0.04	0.02
Queue Length 95th (m)	0.8	0.0	0.0	0.0	0.0	0.9	0.4
Control Delay (s)	9.8	0.0	0.0	0.0	0.0	32.0	11.4
Lane LOS	A					D	B
Approach Delay (s)	0.2			0.0		18.3	
Approach LOS						C	
Intersection Summary							
Average Delay			0.3				
Intersection Capacity Utilization			41.5%		ICU Level of Service		A
Analysis Period (min)			15				

Queues
1: Coleraine Drive & Healey Road

Future Total (2033) -Optimized
PM Peak Hour



Lane Group	EBL	EBT	WBL	WBT	NBL	NBT	SBL	SBT
Lane Configurations	↶	↷	↶	↷	↶	↷	↶	↷
Traffic Volume (vph)	251	228	57	412	355	422	47	191
Future Volume (vph)	251	228	57	412	355	422	47	191
Lane Group Flow (vph)	276	544	63	546	390	522	52	370
Turn Type	pm+pt	NA	Perm	NA	pm+pt	NA	Perm	NA
Protected Phases	3	8		4	1	6		2
Permitted Phases	8		4		6		2	
Detector Phase	3	8	4	4	1	6	2	2
Switch Phase								
Minimum Initial (s)	5.0	8.0	8.0	8.0	5.0	8.0	8.0	8.0
Minimum Split (s)	9.5	32.8	32.8	32.8	9.5	36.7	36.7	36.7
Total Split (s)	20.0	64.0	44.0	44.0	19.0	56.0	37.0	37.0
Total Split (%)	16.7%	53.3%	36.7%	36.7%	15.8%	46.7%	30.8%	30.8%
Yellow Time (s)	3.0	4.0	4.0	4.0	3.0	4.6	4.6	4.6
All-Red Time (s)	0.0	2.8	2.8	2.8	0.0	2.1	2.1	2.1
Lost Time Adjust (s)	0.0	0.0	0.0	0.0	0.0	0.0	0.0	0.0
Total Lost Time (s)	3.0	6.8	6.8	6.8	3.0	6.7	6.7	6.7
Lead/Lag	Lead		Lag	Lag	Lead		Lag	Lag
Lead-Lag Optimize?	Yes		Yes	Yes	Yes		Yes	Yes
Recall Mode	None	None	None	None	None	C-Max	C-Max	C-Max
v/c Ratio	0.97	0.66	0.27	0.99	0.88	0.41	0.30	0.45
Control Delay	71.8	25.7	35.3	78.2	48.9	25.6	42.2	23.6
Queue Delay	0.0	0.0	0.0	0.0	0.0	0.0	0.0	0.0
Total Delay	71.8	25.7	35.3	78.2	48.9	25.6	42.2	23.6
Queue Length 50th (m)	55.6	97.2	11.8	133.0	69.3	46.3	10.5	23.2
Queue Length 95th (m)	m#99.7	m136.3	24.9	#209.0	#123.9	61.6	23.1	38.5
Internal Link Dist (m)		823.7		424.0		1711.9		1121.0
Turn Bay Length (m)	55.0		50.0		80.0		155.0	
Base Capacity (vph)	286	821	230	549	443	1259	172	822
Starvation Cap Reductn	0	0	0	0	0	0	0	0
Spillback Cap Reductn	0	0	0	0	0	0	0	0
Storage Cap Reductn	0	0	0	0	0	0	0	0
Reduced v/c Ratio	0.97	0.66	0.27	0.99	0.88	0.41	0.30	0.45

Intersection Summary





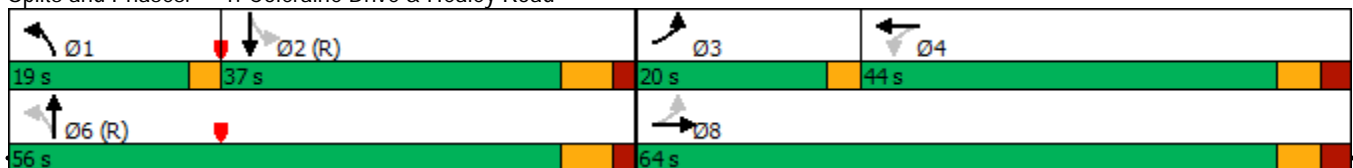

















Cycle Length: 120
 Actuated Cycle Length: 120
 Offset: 0 (0%), Referenced to phase 2:SBTL and 6:NBTL, Start of Green
 Natural Cycle: 110
 Control Type: Actuated-Coordinated
 # 95th percentile volume exceeds capacity, queue may be longer.
 Queue shown is maximum after two cycles.
 m Volume for 95th percentile queue is metered by upstream signal.

Splits and Phases: 1: Coleraine Drive & Healey Road



HCM Signalized Intersection Capacity Analysis
1: Coleraine Drive & Healey Road

Future Total (2033) -Optimized
PM Peak Hour

													
Movement	EBL	EBT	EBR	WBL	WBT	WBR	NBL	NBT	NBR	SBL	SBT	SBR	
Lane Configurations													
Traffic Volume (vph)	251	228	267	57	412	85	355	422	53	47	191	146	
Future Volume (vph)	251	228	267	57	412	85	355	422	53	47	191	146	
Ideal Flow (vphpl)	1900	1900	1900	1900	1900	1900	1900	1900	1900	1900	1900	1900	
Lane Width	3.0	3.5	3.0	3.0	3.5	3.0	3.0	3.5	3.0	3.0	3.5	3.0	
Total Lost time (s)	3.0	6.8		6.8	6.8		3.0	6.7		6.7	6.7		
Lane Util. Factor	1.00	1.00		1.00	1.00		1.00	0.95		1.00	0.95		
Flt	1.00	0.92		1.00	0.97		1.00	0.98		1.00	0.94		
Flt Protected	0.95	1.00		0.95	1.00		0.95	1.00		0.95	1.00		
Satd. Flow (prot)	1589	1650		1546	1754		1652	3047		1416	2803		
Flt Permitted	0.10	1.00		0.46	1.00		0.42	1.00		0.46	1.00		
Satd. Flow (perm)	166	1650		742	1754		725	3047		684	2803		
Peak-hour factor, PHF	0.91	0.91	0.91	0.91	0.91	0.91	0.91	0.91	0.91	0.91	0.91	0.91	
Adj. Flow (vph)	276	251	293	63	453	93	390	464	58	52	210	160	
RTOR Reduction (vph)	0	35	0	0	6	0	0	8	0	0	114	0	
Lane Group Flow (vph)	276	509	0	63	540	0	390	514	0	52	256	0	
Heavy Vehicles (%)	6%	2%	7%	9%	2%	16%	2%	15%	17%	19%	26%	10%	
Turn Type	pm+pt	NA		Perm	NA		pm+pt	NA		Perm	NA		
Protected Phases	3	8			4		1	6			2		
Permitted Phases	8			4			6			2			
Actuated Green, G (s)	57.2	57.2		37.2	37.2		49.3	49.3		30.3	30.3		
Effective Green, g (s)	57.2	57.2		37.2	37.2		49.3	49.3		30.3	30.3		
Actuated g/C Ratio	0.48	0.48		0.31	0.31		0.41	0.41		0.25	0.25		
Clearance Time (s)	3.0	6.8		6.8	6.8		3.0	6.7		6.7	6.7		
Vehicle Extension (s)	3.0	3.0		3.0	3.0		3.0	3.0		3.0	3.0		
Lane Grp Cap (vph)	280	786		230	543		421	1251		172	707		
v/s Ratio Prot	c0.14	0.31			0.31		c0.12	0.17			0.09		
v/s Ratio Perm	c0.33			0.08			c0.26			0.08			
v/c Ratio	0.99	0.65		0.27	0.99		0.93	0.41		0.30	0.36		
Uniform Delay, d1	36.1	23.8		31.2	41.3		30.2	25.1		36.3	36.9		
Progression Factor	0.91	1.03		1.00	1.00		1.00	1.00		1.00	1.00		
Incremental Delay, d2	46.3	1.6		0.6	36.9		26.2	1.0		4.5	1.4		
Delay (s)	79.3	26.1		31.9	78.2		56.4	26.1		40.8	38.3		
Level of Service	E	C		C	E		E	C		D	D		
Approach Delay (s)		44.0			73.4			39.0			38.6		
Approach LOS		D			E			D			D		
Intersection Summary													
HCM 2000 Control Delay			48.0									HCM 2000 Level of Service	D
HCM 2000 Volume to Capacity ratio			1.01										
Actuated Cycle Length (s)			120.0									Sum of lost time (s)	19.5
Intersection Capacity Utilization			88.3%									ICU Level of Service	E
Analysis Period (min)			15										

c Critical Lane Group

Queues
2: Humber Station Road & Healey Road

Future Total (2033) -Optimized
PM Peak Hour

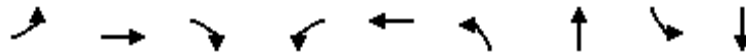

Lane Group	EBL	EBT	EBR	WBL	WBT	NBL	NBT	SBL	SBT
Lane Configurations	↶	↑	↷	↶	↷	↶	↷	↶	↷
Traffic Volume (vph)	21	363	80	180	778	209	228	27	63
Future Volume (vph)	21	363	80	180	778	209	228	27	63
Lane Group Flow (vph)	22	374	82	186	825	215	555	28	71
Turn Type	Perm	NA	Perm	pm+pt	NA	Perm	NA	Perm	NA
Protected Phases		4		3	8		2		6
Permitted Phases	4		4	8		2		6	
Detector Phase	4	4	4	3	8	2	2	6	6
Switch Phase									
Minimum Initial (s)	8.0	8.0	8.0	5.0	8.0	8.0	8.0	8.0	8.0
Minimum Split (s)	24.8	24.8	24.8	8.0	24.8	24.7	24.7	24.7	24.7
Total Split (s)	62.0	62.0	62.0	10.0	72.0	48.0	48.0	48.0	48.0
Total Split (%)	51.7%	51.7%	51.7%	8.3%	60.0%	40.0%	40.0%	40.0%	40.0%
Yellow Time (s)	4.0	4.0	4.0	3.0	4.0	4.6	4.6	4.6	4.6
All-Red Time (s)	2.8	2.8	2.8	0.0	2.8	2.1	2.1	2.1	2.1
Lost Time Adjust (s)	0.0	0.0	0.0	0.0	0.0	0.0	0.0	0.0	0.0
Total Lost Time (s)	6.8	6.8	6.8	3.0	6.8	6.7	6.7	6.7	6.7
Lead/Lag	Lag	Lag	Lag	Lead					
Lead-Lag Optimize?	Yes	Yes	Yes	Yes					
Recall Mode	None	None	None	None	None	C-Max	C-Max	C-Max	C-Max
v/c Ratio	0.25	0.48	0.14	0.49	0.89	0.49	0.84	0.21	0.10
Control Delay	29.2	27.0	7.5	11.8	27.5	42.1	52.1	32.7	24.9
Queue Delay	0.0	0.0	0.0	0.0	0.0	0.0	0.0	0.0	0.0
Total Delay	29.2	27.0	7.5	11.8	27.5	42.1	52.1	32.7	24.9
Queue Length 50th (m)	3.4	63.9	2.9	19.1	168.3	50.8	129.8	4.8	10.9
Queue Length 95th (m)	10.5	87.9	12.2	m22.3	m187.7	77.9	#195.3	13.7	22.3
Internal Link Dist (m)		465.5			505.1		463.9		452.2
Turn Bay Length (m)	30.0		30.0	60.0		30.0		30.0	
Base Capacity (vph)	96	847	630	377	1006	436	659	134	683
Starvation Cap Reductn	0	0	0	0	0	0	0	0	0
Spillback Cap Reductn	0	0	0	0	0	0	0	0	0
Storage Cap Reductn	0	0	0	0	0	0	0	0	0
Reduced v/c Ratio	0.23	0.44	0.13	0.49	0.82	0.49	0.84	0.21	0.10

Intersection Summary

Cycle Length: 120
 Actuated Cycle Length: 120
 Offset: 0 (0%), Referenced to phase 2:NBTL and 6:SBTL, Start of Green
 Natural Cycle: 80
 Control Type: Actuated-Coordinated
 # 95th percentile volume exceeds capacity, queue may be longer.
 Queue shown is maximum after two cycles.
 m Volume for 95th percentile queue is metered by upstream signal.



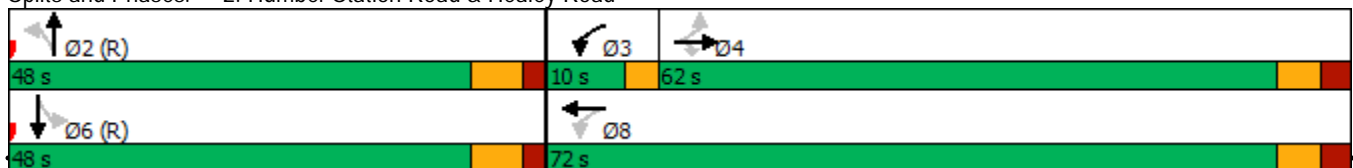



















Splits and Phases: 2: Humber Station Road & Healey Road



HCM Signalized Intersection Capacity Analysis

2: Humber Station Road & Healey Road

Future Total (2033) -Optimized
PM Peak Hour

												
Movement	EBL	EBT	EBR	WBL	WBT	WBR	NBL	NBT	NBR	SBL	SBT	SBR
Lane Configurations												
Traffic Volume (vph)	21	363	80	180	778	22	209	228	310	27	63	6
Future Volume (vph)	21	363	80	180	778	22	209	228	310	27	63	6
Ideal Flow (vphpl)	1900	1900	1900	1900	1900	1900	1900	1900	1900	1900	1900	1900
Lane Width	3.0	3.5	3.0	3.0	3.5	3.0	3.0	3.5	3.0	3.0	3.5	3.0
Total Lost time (s)	6.8	6.8	6.8	3.0	6.8		6.7	6.7		6.7	6.7	
Lane Util. Factor	1.00	1.00	1.00	1.00	1.00		1.00	1.00		1.00	1.00	
Frt	1.00	1.00	0.85	1.00	1.00		1.00	0.91		1.00	0.99	
Flt Protected	0.95	1.00	1.00	0.95	1.00		0.95	1.00		0.95	1.00	
Satd. Flow (prot)	1685	1842	1299	1478	1850		1518	1616		1685	1774	
Flt Permitted	0.12	1.00	1.00	0.39	1.00		0.71	1.00		0.20	1.00	
Satd. Flow (perm)	209	1842	1299	612	1850		1136	1616		349	1774	
Peak-hour factor, PHF	0.97	0.97	0.97	0.97	0.97	0.97	0.97	0.97	0.97	0.97	0.97	0.97
Adj. Flow (vph)	22	374	82	186	802	23	215	235	320	28	65	6
RTOR Reduction (vph)	0	0	35	0	1	0	0	38	0	0	2	0
Lane Group Flow (vph)	22	374	47	186	824	0	215	517	0	28	69	0
Heavy Vehicles (%)	0%	2%	16%	14%	1%	5%	11%	1%	10%	0%	5%	0%
Turn Type	Perm	NA	Perm	pm+pt	NA		Perm	NA		Perm	NA	
Protected Phases		4		3	8			2			6	6
Permitted Phases	4		4	8			2			6		
Actuated Green, G (s)	50.4	50.4	50.4	60.4	60.4		46.1	46.1		46.1	46.1	
Effective Green, g (s)	50.4	50.4	50.4	60.4	60.4		46.1	46.1		46.1	46.1	
Actuated g/C Ratio	0.42	0.42	0.42	0.50	0.50		0.38	0.38		0.38	0.38	
Clearance Time (s)	6.8	6.8	6.8	3.0	6.8		6.7	6.7		6.7	6.7	
Vehicle Extension (s)	3.0	3.0	3.0	3.0	3.0		3.0	3.0		3.0	3.0	
Lane Grp Cap (vph)	87	773	545	358	931		436	620		134	681	
v/s Ratio Prot		0.20		0.03	c0.45			c0.32			0.04	
v/s Ratio Perm	0.11		0.04	0.23			0.19			0.08		
v/c Ratio	0.25	0.48	0.09	0.52	0.89		0.49	0.83		0.21	0.10	
Uniform Delay, d1	22.6	25.3	20.9	19.8	26.7		28.1	33.5		24.7	23.7	
Progression Factor	1.00	1.00	1.00	0.62	0.74		1.26	1.30		1.00	1.00	
Incremental Delay, d2	1.5	0.5	0.1	0.8	6.5		3.7	11.8		3.5	0.3	
Delay (s)	24.1	25.8	21.0	13.0	26.1		39.0	55.4		28.3	24.0	
Level of Service	C	C	C	B	C		D	E		C	C	
Approach Delay (s)		24.9			23.7			50.8			25.2	
Approach LOS		C			C			D			C	
Intersection Summary												
HCM 2000 Control Delay			32.9	HCM 2000 Level of Service				C				
HCM 2000 Volume to Capacity ratio			0.89									
Actuated Cycle Length (s)			120.0	Sum of lost time (s)				16.5				
Intersection Capacity Utilization			96.9%	ICU Level of Service				F				
Analysis Period (min)			15									

c Critical Lane Group

Queues

Future Total (2033) -Optimized

3: Clarkway Drive/Humber Station Road & Mayfield Road

PM Peak Hour

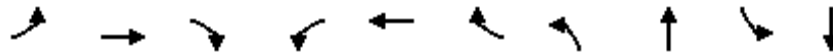

Lane Group	EBL	EBT	EBR	WBL	WBT	WBR	NBL	NBT	SBL	SBT
Lane Configurations	↘	↑↑↑	↗	↘	↑↑	↗	↘	↗	↘	↗
Traffic Volume (vph)	193	804	19	142	936	101	59	402	97	300
Future Volume (vph)	193	804	19	142	936	101	59	402	97	300
Lane Group Flow (vph)	199	829	20	146	965	104	61	598	100	637
Turn Type	pm+pt	NA	Perm	Perm	NA	Perm	Perm	NA	Perm	NA
Protected Phases	5	2			6			4		8
Permitted Phases	2		2	6		6	4		8	
Detector Phase	5	2	2	6	6	6	4	4	8	8
Switch Phase										
Minimum Initial (s)	5.0	12.0	12.0	12.0	12.0	12.0	8.0	8.0	8.0	8.0
Minimum Split (s)	9.5	27.3	27.3	27.3	27.3	27.3	26.0	26.0	26.0	26.0
Total Split (s)	15.0	62.0	62.0	47.0	47.0	47.0	58.0	58.0	58.0	58.0
Total Split (%)	12.5%	51.7%	51.7%	39.2%	39.2%	39.2%	48.3%	48.3%	48.3%	48.3%
Yellow Time (s)	3.0	4.6	4.6	4.6	4.6	4.6	4.2	4.2	4.2	4.2
All-Red Time (s)	0.0	2.7	2.7	2.7	2.7	2.7	2.8	2.8	2.8	2.8
Lost Time Adjust (s)	0.0	0.0	0.0	0.0	0.0	0.0	0.0	0.0	0.0	0.0
Total Lost Time (s)	3.0	7.3	7.3	7.3	7.3	7.3	7.0	7.0	7.0	7.0
Lead/Lag	Lead			Lag	Lag	Lag				
Lead-Lag Optimize?	Yes			Yes	Yes	Yes				
Recall Mode	None	C-Max	C-Max	C-Max	C-Max	C-Max	None	None	None	None
v/c Ratio	0.89	0.38	0.03	0.80	0.88	0.20	0.65	0.85	0.85	0.95
Control Delay	63.3	21.2	2.5	69.2	48.4	6.4	62.3	43.3	74.2	51.2
Queue Delay	0.0	0.0	0.0	0.0	0.0	0.0	0.0	0.0	0.0	0.0
Total Delay	63.3	21.2	2.5	69.2	48.4	6.4	62.3	43.3	74.2	51.2
Queue Length 50th (m)	32.1	48.6	0.0	33.1	119.3	0.0	11.6	123.7	25.4	155.8
Queue Length 95th (m)	#80.9	59.8	2.4	#72.6	#158.5	12.6	#35.6	175.5	m#45.7	#218.4
Internal Link Dist (m)		1635.6			190.4			1951.8		1542.4
Turn Bay Length (m)	150.0		105.0	150.0		115.0	75.0		105.0	
Base Capacity (vph)	224	2210	662	182	1095	514	98	736	124	695
Starvation Cap Reductn	0	0	0	0	0	0	0	0	0	0
Spillback Cap Reductn	0	0	0	0	0	0	0	0	0	0
Storage Cap Reductn	0	0	0	0	0	0	0	0	0	0
Reduced v/c Ratio	0.89	0.38	0.03	0.80	0.88	0.20	0.62	0.81	0.81	0.92

Intersection Summary

Cycle Length: 120
 Actuated Cycle Length: 120
 Offset: 0 (0%), Referenced to phase 2:EBTL and 6:WBTL, Start of Green
 Natural Cycle: 90
 Control Type: Actuated-Coordinated
 # 95th percentile volume exceeds capacity, queue may be longer.
 Queue shown is maximum after two cycles.
 m Volume for 95th percentile queue is metered by upstream signal.

Splits and Phases: 3: Clarkway Drive/Humber Station Road & Mayfield Road

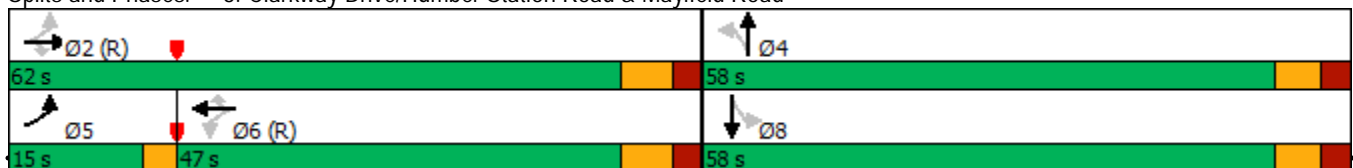

HCM Signalized Intersection Capacity Analysis

3: Clarkway Drive/Humber Station Road & Mayfield Road

Future Total (2033) -Optimized
PM Peak Hour



Movement	EBL	EBT	EBR	WBL	WBT	WBR	NBL	NBT	NBR	SBL	SBT	SBR
Lane Configurations	↘	↑↑↑	↗	↘	↑↑	↗	↘	↗		↘	↗	
Traffic Volume (vph)	193	804	19	142	936	101	59	402	178	97	300	318
Future Volume (vph)	193	804	19	142	936	101	59	402	178	97	300	318
Ideal Flow (vphpl)	1900	1900	1900	1900	1900	1900	1900	1900	1900	1900	1900	1900
Lane Width	3.0	3.5	3.0	3.0	3.5	3.0	3.0	3.5	3.0	3.0	3.5	3.0
Total Lost time (s)	3.0	7.3	7.3	7.3	7.3	7.3	7.0	7.0		7.0	7.0	
Lane Util. Factor	1.00	0.91	1.00	1.00	0.95	1.00	1.00	1.00		1.00	1.00	
Frt	1.00	1.00	0.85	1.00	1.00	0.85	1.00	0.95		1.00	0.92	
Flt Protected	0.95	1.00	1.00	0.95	1.00	1.00	0.95	1.00		0.95	1.00	
Satd. Flow (prot)	1416	4663	1358	1560	3245	1322	1504	1701		1518	1562	
Flt Permitted	0.11	1.00	1.00	0.33	1.00	1.00	0.15	1.00		0.18	1.00	
Satd. Flow (perm)	168	4663	1358	538	3245	1322	231	1701		293	1562	
Peak-hour factor, PHF	0.97	0.97	0.97	0.97	0.97	0.97	0.97	0.97	0.97	0.97	0.97	0.97
Adj. Flow (vph)	199	829	20	146	965	104	61	414	184	100	309	328
RTOR Reduction (vph)	0	0	11	0	0	69	0	14	0	0	33	0
Lane Group Flow (vph)	199	829	9	146	965	35	61	584	0	100	604	0
Heavy Vehicles (%)	19%	10%	11%	8%	10%	14%	12%	6%	4%	11%	10%	12%
Turn Type	pm+pt	NA	Perm	Perm	NA	Perm	Perm	NA		Perm	NA	
Protected Phases	5	2			6			4			8	
Permitted Phases	2		2	6		6	4			8		
Actuated Green, G (s)	56.9	56.9	56.9	40.5	40.5	40.5	48.8	48.8		48.8	48.8	
Effective Green, g (s)	56.9	56.9	56.9	40.5	40.5	40.5	48.8	48.8		48.8	48.8	
Actuated g/C Ratio	0.47	0.47	0.47	0.34	0.34	0.34	0.41	0.41		0.41	0.41	
Clearance Time (s)	3.0	7.3	7.3	7.3	7.3	7.3	7.0	7.0		7.0	7.0	
Vehicle Extension (s)	3.0	3.0	3.0	3.0	3.0	3.0	3.0	3.0		3.0	3.0	
Lane Grp Cap (vph)	219	2211	643	181	1095	446	93	691		119	635	
v/s Ratio Prot	c0.10	0.18			0.30			0.34			c0.39	
v/s Ratio Perm	c0.33		0.01	0.27		0.03	0.26			0.34		
v/c Ratio	0.91	0.37	0.01	0.81	0.88	0.08	0.66	0.85		0.84	0.95	
Uniform Delay, d1	28.8	20.2	16.7	36.2	37.5	27.1	28.8	32.2		32.1	34.5	
Progression Factor	1.00	1.00	1.00	1.00	1.00	1.00	1.00	1.00		0.88	0.90	
Incremental Delay, d2	36.4	0.5	0.0	30.7	10.2	0.3	15.4	9.4		33.7	21.5	
Delay (s)	65.2	20.7	16.7	66.9	47.7	27.4	44.2	41.6		61.9	52.5	
Level of Service	E	C	B	E	D	C	D	D		E	D	
Approach Delay (s)		29.0			48.3			41.8			53.7	
Approach LOS		C			D			D			D	

Intersection Summary

HCM 2000 Control Delay	42.7	HCM 2000 Level of Service	D
HCM 2000 Volume to Capacity ratio	0.95		
Actuated Cycle Length (s)	120.0	Sum of lost time (s)	17.3
Intersection Capacity Utilization	99.6%	ICU Level of Service	F
Analysis Period (min)	15		

c Critical Lane Group

Queues

Future Total (2033) -Optimized

4: Coleraine Drive & Mayfield Road

PM Peak Hour

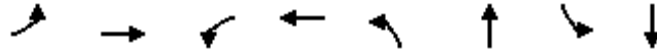

Lane Group	EBL	EBT	WBL	WBT	NBL	NBT	SBL	SBT
Lane Configurations	↶	↶↷	↶	↶↷	↶	↶↷	↶	↶↷
Traffic Volume (vph)	278	788	13	702	52	338	65	201
Future Volume (vph)	278	788	13	702	52	338	65	201
Lane Group Flow (vph)	293	860	14	830	55	378	68	512
Turn Type	pm+pt	NA	Perm	NA	Perm	NA	pm+pt	NA
Protected Phases	5	2		6		4	3	8
Permitted Phases	2		6		4		8	
Detector Phase	5	2	6	6	4	4	3	8
Switch Phase								
Minimum Initial (s)	5.0	12.0	12.0	12.0	12.0	12.0	5.0	12.0
Minimum Split (s)	8.0	37.0	37.0	37.0	37.0	37.0	8.0	37.0
Total Split (s)	12.0	80.0	68.0	68.0	36.0	36.0	14.0	50.0
Total Split (%)	9.2%	61.5%	52.3%	52.3%	27.7%	27.7%	10.8%	38.5%
Yellow Time (s)	3.0	4.6	4.6	4.6	4.2	4.2	3.0	4.2
All-Red Time (s)	0.0	2.4	2.4	2.4	2.8	2.8	0.0	2.8
Lost Time Adjust (s)	0.0	0.0	0.0	0.0	0.0	0.0	0.0	0.0
Total Lost Time (s)	3.0	7.0	7.0	7.0	7.0	7.0	3.0	7.0
Lead/Lag	Lead		Lag	Lag	Lag	Lag	Lead	
Lead-Lag Optimize?	Yes		Yes	Yes	Yes	Yes	Yes	
Recall Mode	None	C-Max	C-Max	C-Max	None	None	None	None
v/c Ratio	0.69	0.39	0.05	0.51	0.46	0.73	0.38	0.58
Control Delay	19.7	11.4	19.6	23.8	62.5	60.6	41.0	22.8
Queue Delay	0.0	0.0	0.0	0.0	0.0	0.0	0.0	0.0
Total Delay	19.7	11.4	19.6	23.8	62.5	60.6	41.0	22.8
Queue Length 50th (m)	29.6	54.3	2.0	80.9	13.8	51.4	13.9	30.4
Queue Length 95th (m)	#61.7	76.2	6.2	101.0	27.4	66.2	25.1	45.9
Internal Link Dist (m)		290.4		1003.7		791.2		576.8
Turn Bay Length (m)	100.0		85.0		105.0		145.0	
Base Capacity (vph)	422	2231	270	1614	183	792	189	1173
Starvation Cap Reductn	0	0	0	0	0	0	0	0
Spillback Cap Reductn	0	0	0	0	0	0	0	0
Storage Cap Reductn	0	0	0	0	0	0	0	0
Reduced v/c Ratio	0.69	0.39	0.05	0.51	0.30	0.48	0.36	0.44

Intersection Summary





















Cycle Length: 130
 Actuated Cycle Length: 130
 Offset: 116 (89%), Referenced to phase 2:EBTL and 6:WBTL, Start of Green
 Natural Cycle: 90
 Control Type: Actuated-Coordinated
 # 95th percentile volume exceeds capacity, queue may be longer.
 Queue shown is maximum after two cycles.

Splits and Phases: 4: Coleraine Drive & Mayfield Road



HCM Signalized Intersection Capacity Analysis
4: Coleraine Drive & Mayfield Road

Future Total (2033) -Optimized
PM Peak Hour

												
Movement	EBL	EBT	EBR	WBL	WBT	WBR	NBL	NBT	NBR	SBL	SBT	SBR
Lane Configurations												
Traffic Volume (vph)	278	788	29	13	702	86	52	338	21	65	201	285
Future Volume (vph)	278	788	29	13	702	86	52	338	21	65	201	285
Ideal Flow (vphpl)	1900	1900	1900	1900	1900	1900	1900	1900	1900	1900	1900	1900
Lane Width	3.0	3.5	3.0	3.0	3.5	3.0	3.0	3.5	3.0	3.0	3.5	3.0
Total Lost time (s)	3.0	7.0		7.0	7.0		7.0	7.0		3.0	7.0	
Lane Util. Factor	1.00	0.95		1.00	0.95		1.00	0.95		1.00	0.95	
Fr _t	1.00	0.99		1.00	0.98		1.00	0.99		1.00	0.91	
Fl _t Protected	0.95	1.00		0.95	1.00		0.95	1.00		0.95	1.00	
Satd. Flow (prot)	1465	3356		1560	3206		1685	3539		1370	3026	
Fl _t Permitted	0.25	1.00		0.33	1.00		0.46	1.00		0.29	1.00	
Satd. Flow (perm)	392	3356		541	3206		821	3539		422	3026	
Peak-hour factor, PHF	0.95	0.95	0.95	0.95	0.95	0.95	0.95	0.95	0.95	0.95	0.95	0.95
Adj. Flow (vph)	293	829	31	14	739	91	55	356	22	68	212	300
RTOR Reduction (vph)	0	2	0	0	7	0	0	3	0	0	199	0
Lane Group Flow (vph)	293	858	0	14	823	0	55	375	0	68	313	0
Heavy Vehicles (%)	15%	6%	0%	8%	8%	22%	0%	0%	0%	23%	0%	13%
Turn Type	pm+pt	NA		Perm	NA		Perm	NA		pm+pt	NA	
Protected Phases	5	2			6			4		3	8	
Permitted Phases	2			6			4			8		
Actuated Green, G (s)	85.8	85.8		64.6	64.6		19.0	19.0		30.2	30.2	
Effective Green, g (s)	85.8	85.8		64.6	64.6		19.0	19.0		30.2	30.2	
Actuated g/C Ratio	0.66	0.66		0.50	0.50		0.15	0.15		0.23	0.23	
Clearance Time (s)	3.0	7.0		7.0	7.0		7.0	7.0		3.0	7.0	
Vehicle Extension (s)	3.0	3.0		3.0	3.0		3.0	3.0		3.0	3.0	
Lane Grp Cap (vph)	408	2214		268	1593		119	517		157	702	
v/s Ratio Prot	c0.10	0.26			0.26			c0.11		0.03	c0.10	
v/s Ratio Perm	c0.37			0.03			0.07			0.07		
v/c Ratio	0.72	0.39		0.05	0.52		0.46	0.72		0.43	0.45	
Uniform Delay, d ₁	11.9	10.1		16.9	22.1		50.8	53.0		40.7	42.7	
Progression Factor	1.00	1.00		1.00	1.00		1.00	1.00		1.00	1.00	
Incremental Delay, d ₂	5.9	0.5		0.4	1.2		2.8	5.0		1.9	0.5	
Delay (s)	17.9	10.6		17.3	23.3		53.6	58.0		42.6	43.2	
Level of Service	B	B		B	C		D	E		D	D	
Approach Delay (s)		12.5			23.2			57.4			43.1	
Approach LOS		B			C			E			D	
Intersection Summary												
HCM 2000 Control Delay			27.9				HCM 2000 Level of Service				C	
HCM 2000 Volume to Capacity ratio			0.72									
Actuated Cycle Length (s)			130.0				Sum of lost time (s)			20.0		
Intersection Capacity Utilization			83.1%				ICU Level of Service			E		
Analysis Period (min)			15									

c Critical Lane Group

Queues

Future Total (2033) -Optimized

5: Coleraine Drive & Private Access/George Bolton Parkway

PM Peak Hour



Lane Group	EBL	EBT	WBL	WBT	NBL	NBT	SBL	SBT	SBR
Lane Configurations	↶	↷	↶	↷	↶	↷	↶	↷	↷
Traffic Volume (vph)	7	26	61	9	6	616	230	537	1
Future Volume (vph)	7	26	61	9	6	616	230	537	1
Lane Group Flow (vph)	8	58	73	200	7	826	277	647	1
Turn Type	Perm	NA	Perm	NA	Perm	NA	Perm	NA	Perm
Protected Phases		8		4		6		2	
Permitted Phases	8		4		6		2		2
Detector Phase	8	8	4	4	6	6	2	2	2
Switch Phase									
Minimum Initial (s)	8.0	8.0	12.0	12.0	12.0	12.0	12.0	12.0	12.0
Minimum Split (s)	32.5	32.5	32.5	32.5	34.2	34.2	33.7	33.7	33.7
Total Split (s)	45.0	45.0	45.0	45.0	55.0	55.0	55.0	55.0	55.0
Total Split (%)	45.0%	45.0%	45.0%	45.0%	55.0%	55.0%	55.0%	55.0%	55.0%
Yellow Time (s)	4.0	4.0	4.0	4.0	4.2	4.2	4.2	4.2	4.2
All-Red Time (s)	3.5	3.5	3.5	3.5	2.5	2.5	2.5	2.5	2.5
Lost Time Adjust (s)	0.0	0.0	0.0	0.0	0.0	0.0	0.0	0.0	0.0
Total Lost Time (s)	7.5	7.5	7.5	7.5	6.7	6.7	6.7	6.7	6.7
Lead/Lag									
Lead-Lag Optimize?									
Recall Mode	None	None	None	None	C-Max	C-Max	C-Max	C-Max	C-Max
v/c Ratio	0.07	0.24	0.48	0.61	0.02	0.36	0.71	0.28	0.00
Control Delay	37.6	25.7	50.0	21.3	4.8	5.9	21.6	5.5	0.0
Queue Delay	0.0	0.0	0.0	0.0	0.0	0.0	0.0	0.0	0.0
Total Delay	37.6	25.7	50.0	21.3	4.8	5.9	21.6	5.5	0.0
Queue Length 50th (m)	1.5	5.8	14.2	10.6	0.3	25.7	25.5	19.2	0.0
Queue Length 95th (m)	5.3	14.8	24.9	26.4	1.7	38.8	65.1	29.6	0.0
Internal Link Dist (m)		152.4		468.8		784.9		1711.9	
Turn Bay Length (m)	70.0		105.0		75.0		100.0		100.0
Base Capacity (vph)	318	619	423	648	346	2266	390	2280	1101
Starvation Cap Reductn	0	0	0	0	0	0	0	0	0
Spillback Cap Reductn	0	0	0	0	0	0	0	0	0
Storage Cap Reductn	0	0	0	0	0	0	0	0	0
Reduced v/c Ratio	0.03	0.09	0.17	0.31	0.02	0.36	0.71	0.28	0.00

Intersection Summary

Cycle Length: 100

Actuated Cycle Length: 100

Offset: 0 (0%), Referenced to phase 2:SBTL and 6:NBTL, Start of Green

Natural Cycle: 90

Control Type: Actuated-Coordinated

Splits and Phases: 5: Coleraine Drive & Private Access/George Bolton Parkway

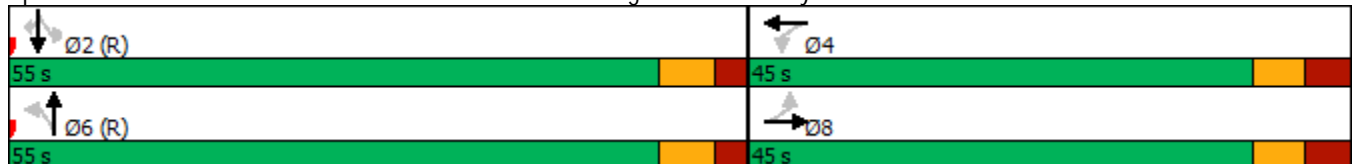























HCM Signalized Intersection Capacity Analysis

Future Total (2033) -Optimized

5: Coleraine Drive & Private Access/George Bolton Parkway

PM Peak Hour

												
Movement	EBL	EBT	EBR	WBL	WBT	WBR	NBL	NBT	NBR	SBL	SBT	SBR
Lane Configurations												
Traffic Volume (vph)	7	26	22	61	9	157	6	616	70	230	537	1
Future Volume (vph)	7	26	22	61	9	157	6	616	70	230	537	1
Ideal Flow (vphpl)	1900	1900	1900	1900	1900	1900	1900	1900	1900	1900	1900	1900
Lane Width	3.0	3.5	3.0	3.0	3.5	3.0	3.0	3.5	3.0	3.0	3.5	3.0
Total Lost time (s)	7.5	7.5		7.5	7.5		6.7	6.7		6.7	6.7	6.7
Lane Util. Factor	1.00	1.00		1.00	1.00		1.00	0.95		1.00	0.95	1.00
Frt	1.00	0.93		1.00	0.86		1.00	0.98		1.00	1.00	0.85
Flt Protected	0.95	1.00		0.95	1.00		0.95	1.00		0.95	1.00	1.00
Satd. Flow (prot)	1685	1608		1491	1491		1123	3133		1560	3159	1507
Flt Permitted	0.48	1.00		0.72	1.00		0.41	1.00		0.33	1.00	1.00
Satd. Flow (perm)	849	1608		1129	1491		480	3133		542	3159	1507
Peak-hour factor, PHF	0.83	0.83	0.83	0.83	0.83	0.83	0.83	0.83	0.83	0.83	0.83	0.83
Adj. Flow (vph)	8	31	27	73	11	189	7	742	84	277	647	1
RTOR Reduction (vph)	0	23	0	0	124	0	0	5	0	0	0	0
Lane Group Flow (vph)	8	35	0	73	76	0	7	821	0	277	647	1
Heavy Vehicles (%)	0%	4%	14%	13%	11%	8%	50%	12%	14%	8%	13%	0%
Turn Type	Perm	NA		Perm	NA		Perm	NA		Perm	NA	Perm
Protected Phases		8			4			6			2	
Permitted Phases	8			4			6			2		2
Actuated Green, G (s)	13.6	13.6		13.6	13.6		72.2	72.2		72.2	72.2	72.2
Effective Green, g (s)	13.6	13.6		13.6	13.6		72.2	72.2		72.2	72.2	72.2
Actuated g/C Ratio	0.14	0.14		0.14	0.14		0.72	0.72		0.72	0.72	0.72
Clearance Time (s)	7.5	7.5		7.5	7.5		6.7	6.7		6.7	6.7	6.7
Vehicle Extension (s)	3.0	3.0		3.0	3.0		3.0	3.0		3.0	3.0	3.0
Lane Grp Cap (vph)	115	218		153	202		346	2262		391	2280	1088
v/s Ratio Prot		0.02			0.05			0.26			0.20	
v/s Ratio Perm	0.01			c0.06			0.01			c0.51		0.00
v/c Ratio	0.07	0.16		0.48	0.37		0.02	0.36		0.71	0.28	0.00
Uniform Delay, d1	37.7	38.1		39.9	39.3		3.9	5.2		7.9	4.9	3.9
Progression Factor	1.00	1.00		1.00	1.00		1.00	1.00		1.00	1.00	1.00
Incremental Delay, d2	0.3	0.3		2.3	1.2		0.1	0.5		10.4	0.3	0.0
Delay (s)	37.9	38.5		42.3	40.5		4.0	5.7		18.3	5.2	3.9
Level of Service	D	D		D	D		A	A		B	A	A
Approach Delay (s)		38.4			41.0			5.7			9.1	
Approach LOS		D			D			A			A	

Intersection Summary		
HCM 2000 Control Delay	12.8	HCM 2000 Level of Service
HCM 2000 Volume to Capacity ratio	0.67	B
Actuated Cycle Length (s)	100.0	Sum of lost time (s)
Intersection Capacity Utilization	59.6%	14.2
Analysis Period (min)	15	ICU Level of Service
		B

c Critical Lane Group

Queues
6: Highway 50 & George Bolton Parkway/Private Access

Future Total (2033) -Optimized
PM Peak Hour



Lane Group	EBL	EBT	WBL	WBT	NBL	NBT	SBL	SBT	SBR
Lane Configurations	↖	↗		↕	↖	↗	↖	↕	↗
Traffic Volume (vph)	253	0	5	0	144	1393	1	988	169
Future Volume (vph)	253	0	5	0	144	1393	1	988	169
Lane Group Flow (vph)	264	244	0	12	150	1451	1	1029	176
Turn Type	Perm	NA	Perm	NA	pm+pt	NA	Perm	NA	Perm
Protected Phases		8		4	1	6		2	
Permitted Phases	8		4		6		2		2
Detector Phase	8	8	4	4	1	6	2	2	2
Switch Phase									
Minimum Initial (s)	8.0	8.0	8.0	8.0	5.0	12.0	12.0	12.0	12.0
Minimum Split (s)	32.6	32.6	32.6	32.6	8.0	27.3	27.3	27.3	27.3
Total Split (s)	35.0	35.0	35.0	35.0	10.0	85.0	75.0	75.0	75.0
Total Split (%)	29.2%	29.2%	29.2%	29.2%	8.3%	70.8%	62.5%	62.5%	62.5%
Yellow Time (s)	4.0	4.0	4.0	4.0	3.0	4.0	4.0	4.0	4.0
All-Red Time (s)	2.6	2.6	2.6	2.6	0.0	2.3	2.3	2.3	2.3
Lost Time Adjust (s)	0.0	0.0		0.0	0.0	0.0	0.0	0.0	0.0
Total Lost Time (s)	6.6	6.6		6.6	3.0	6.3	6.3	6.3	6.3
Lead/Lag					Lead		Lag	Lag	Lag
Lead-Lag Optimize?					Yes		Yes	Yes	Yes
Recall Mode	None	None	None	None	None	C-Max	C-Max	C-Max	C-Max
v/c Ratio	0.91	0.53		0.03	0.53	0.63	0.01	0.51	0.19
Control Delay	80.7	14.4		0.2	13.7	13.3	11.0	16.2	2.2
Queue Delay	0.0	0.0		0.0	0.0	0.0	0.0	0.0	0.0
Total Delay	80.7	14.4		0.2	13.7	13.3	11.0	16.2	2.2
Queue Length 50th (m)	63.2	10.3		0.0	12.0	103.7	0.1	77.5	0.0
Queue Length 95th (m)	#111.5	35.8		0.0	20.0	125.8	0.9	95.5	9.7
Internal Link Dist (m)		846.5		43.0		1045.6		1307.8	
Turn Bay Length (m)	85.0				40.0		135.0		60.0
Base Capacity (vph)	305	479		403	282	2295	154	2024	916
Starvation Cap Reductn	0	0		0	0	0	0	0	0
Spillback Cap Reductn	0	0		0	0	0	0	0	0
Storage Cap Reductn	0	0		0	0	0	0	0	0
Reduced v/c Ratio	0.87	0.51		0.03	0.53	0.63	0.01	0.51	0.19

Intersection Summary





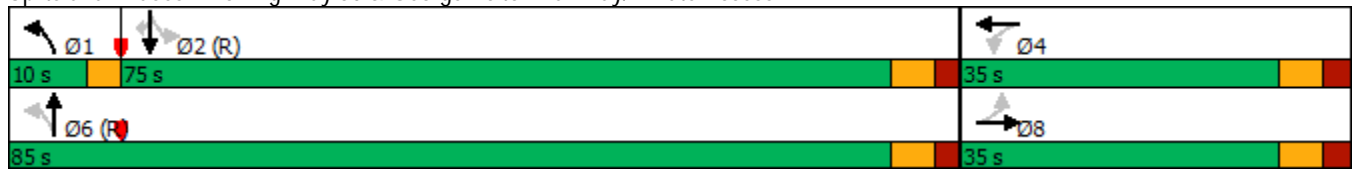















Cycle Length: 120
 Actuated Cycle Length: 120
 Offset: 116 (97%), Referenced to phase 2:SBTL and 6:NBTL, Start of Green
 Natural Cycle: 70
 Control Type: Actuated-Coordinated
 # 95th percentile volume exceeds capacity, queue may be longer.
 Queue shown is maximum after two cycles.

Splits and Phases: 6: Highway 50 & George Bolton Parkway/Private Access



HCM Signalized Intersection Capacity Analysis
 6: Highway 50 & George Bolton Parkway/Private Access

Future Total (2033) -Optimized
 PM Peak Hour

												
Movement	EBL	EBT	EBR	WBL	WBT	WBR	NBL	NBT	NBR	SBL	SBT	SBR
Lane Configurations												
Traffic Volume (vph)	253	0	234	5	0	7	144	1393	0	1	988	169
Future Volume (vph)	253	0	234	5	0	7	144	1393	0	1	988	169
Ideal Flow (vphpl)	1900	1900	1900	1900	1900	1900	1900	1900	1900	1900	1900	1900
Lane Width	3.0	3.5	3.0	3.0	3.5	3.0	3.0	3.5	3.0	3.0	3.5	3.0
Total Lost time (s)	6.6	6.6			6.6		3.0	6.3		6.3	6.3	6.3
Lane Util. Factor	1.00	1.00			1.00		1.00	0.95		1.00	0.95	1.00
Frbp, ped/bikes	1.00	0.99			1.00		1.00	1.00		1.00	1.00	0.98
Flpb, ped/bikes	1.00	1.00			1.00		1.00	1.00		1.00	1.00	1.00
Frt	1.00	0.85			0.92		1.00	1.00		1.00	1.00	0.85
Flt Protected	0.95	1.00			0.98		0.95	1.00		0.95	1.00	1.00
Satd. Flow (prot)	1636	1405			1694		1416	3433		1685	3466	1444
Flt Permitted	0.75	1.00			0.88		0.21	1.00		0.15	1.00	1.00
Satd. Flow (perm)	1291	1405			1523		312	3433		264	3466	1444
Peak-hour factor, PHF	0.96	0.96	0.96	0.96	0.96	0.96	0.96	0.96	0.96	0.96	0.96	0.96
Adj. Flow (vph)	264	0	244	5	0	7	150	1451	0	1	1029	176
RTOR Reduction (vph)	0	149	0	0	9	0	0	0	0	0	0	73
Lane Group Flow (vph)	264	95	0	0	3	0	150	1451	0	1	1029	103
Confl. Peds. (#/hr)			2	2			1					1
Heavy Vehicles (%)	3%	0%	12%	0%	0%	0%	19%	4%	0%	0%	3%	2%
Turn Type	Perm	NA		Perm	NA		pm+pt	NA		Perm	NA	Perm
Protected Phases		8			4		1	6			2	
Permitted Phases	8			4			6			2		2
Actuated Green, G (s)	26.9	26.9			26.9		80.2	80.2		70.1	70.1	70.1
Effective Green, g (s)	26.9	26.9			26.9		80.2	80.2		70.1	70.1	70.1
Actuated g/C Ratio	0.22	0.22			0.22		0.67	0.67		0.58	0.58	0.58
Clearance Time (s)	6.6	6.6			6.6		3.0	6.3		6.3	6.3	6.3
Vehicle Extension (s)	3.0	3.0			3.0		3.0	3.0		3.0	3.0	3.0
Lane Grp Cap (vph)	289	314			341		273	2294		154	2024	843
v/s Ratio Prot		0.07					0.03	c0.42			0.30	
v/s Ratio Perm	c0.20				0.00		0.33			0.00		0.07
v/c Ratio	0.91	0.30			0.01		0.55	0.63		0.01	0.51	0.12
Uniform Delay, d1	45.4	38.7			36.2		9.5	11.4		10.4	14.8	11.2
Progression Factor	1.00	1.00			1.00		1.00	1.00		1.00	1.00	1.00
Incremental Delay, d2	31.2	0.5			0.0		2.3	1.3		0.1	0.9	0.3
Delay (s)	76.7	39.3			36.2		11.8	12.8		10.5	15.7	11.5
Level of Service	E	D			D		B	B		B	B	B
Approach Delay (s)		58.7			36.2			12.7			15.1	
Approach LOS		E			D			B			B	
Intersection Summary												
HCM 2000 Control Delay			20.7				HCM 2000 Level of Service			C		
HCM 2000 Volume to Capacity ratio			0.72									
Actuated Cycle Length (s)			120.0				Sum of lost time (s)			15.9		
Intersection Capacity Utilization			85.3%				ICU Level of Service			E		
Analysis Period (min)			15									
c Critical Lane Group												

Queues
 9: Humber Station Road & Subject Lands Site Access #1

Future Total (2033) -Optimized
 PM Peak Hour

Lane Group	WBL	WBR	NBT	NBR	SBL	SBT
Lane Configurations						
Traffic Volume (vph)	475	292	445	251	140	240
Future Volume (vph)	475	292	445	251	140	240
Lane Group Flow (vph)	475	292	445	251	140	240
Turn Type	Prot	Perm	NA	Perm	Perm	NA
Protected Phases	8		2			6
Permitted Phases		8		2	6	
Detector Phase	8	8	2	2	6	6
Switch Phase						
Minimum Initial (s)	12.0	12.0	12.0	12.0	12.0	12.0
Minimum Split (s)	25.5	25.5	24.7	24.7	24.7	24.7
Total Split (s)	59.0	59.0	61.0	61.0	61.0	61.0
Total Split (%)	49.2%	49.2%	50.8%	50.8%	50.8%	50.8%
Yellow Time (s)	4.0	4.0	4.2	4.2	4.2	4.2
All-Red Time (s)	3.5	3.5	2.5	2.5	2.5	2.5
Lost Time Adjust (s)	0.0	0.0	0.0	0.0	0.0	0.0
Total Lost Time (s)	7.5	7.5	6.7	6.7	6.7	6.7
Lead/Lag						
Lead-Lag Optimize?						
Recall Mode	None	None	C-Max	C-Max	C-Max	C-Max
v/c Ratio	0.87	0.43	0.48	0.35	0.44	0.27
Control Delay	52.9	4.6	18.7	8.1	22.8	15.3
Queue Delay	0.0	0.0	0.0	0.0	0.0	0.0
Total Delay	52.9	4.6	18.7	8.1	22.8	15.3
Queue Length 50th (m)	107.3	0.0	44.9	6.5	22.1	22.4
Queue Length 95th (m)	140.2	16.5	m88.2	m10.1	47.7	54.5
Internal Link Dist (m)	321.1		1542.4			467.1
Turn Bay Length (m)	100.0			30.0	100.0	
Base Capacity (vph)	645	744	931	724	315	897
Starvation Cap Reductn	0	0	0	0	0	0
Spillback Cap Reductn	0	0	0	0	0	0
Storage Cap Reductn	0	0	0	0	0	0
Reduced v/c Ratio	0.74	0.39	0.48	0.35	0.44	0.27

Intersection Summary





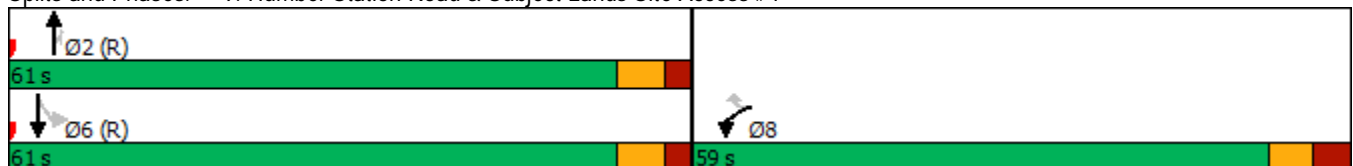







Cycle Length: 120
 Actuated Cycle Length: 120
 Offset: 0 (0%), Referenced to phase 2:NBT and 6:SBTL, Start of Green
 Natural Cycle: 60
 Control Type: Actuated-Coordinated
 m Volume for 95th percentile queue is metered by upstream signal.

Splits and Phases: 9: Humber Station Road & Subject Lands Site Access #1



HCM Signalized Intersection Capacity Analysis
 9: Humber Station Road & Subject Lands Site Access #1

Future Total (2033) -Optimized
 PM Peak Hour

						
Movement	WBL	WBR	NBT	NBR	SBL	SBT
Lane Configurations						
Traffic Volume (vph)	475	292	445	251	140	240
Future Volume (vph)	475	292	445	251	140	240
Ideal Flow (vphpl)	1900	1900	1900	1900	1900	1900
Lane Width	3.0	3.0	3.5	3.0	3.0	3.5
Total Lost time (s)	7.5	7.5	6.7	6.7	6.7	6.7
Lane Util. Factor	1.00	1.00	1.00	1.00	1.00	1.00
Frt	1.00	0.85	1.00	0.85	1.00	1.00
Flt Protected	0.95	1.00	1.00	1.00	0.95	1.00
Satd. Flow (prot)	1504	1346	1789	1256	1416	1724
Flt Permitted	0.95	1.00	1.00	1.00	0.41	1.00
Satd. Flow (perm)	1504	1346	1789	1256	606	1724
Peak-hour factor, PHF	1.00	1.00	1.00	1.00	1.00	1.00
Adj. Flow (vph)	475	292	445	251	140	240
RTOR Reduction (vph)	0	187	0	70	0	0
Lane Group Flow (vph)	475	105	445	181	140	240
Heavy Vehicles (%)	12%	12%	5%	20%	19%	9%
Turn Type	Prot	Perm	NA	Perm	Perm	NA
Protected Phases	8		2			6
Permitted Phases		8		2	6	
Actuated Green, G (s)	43.3	43.3	62.5	62.5	62.5	62.5
Effective Green, g (s)	43.3	43.3	62.5	62.5	62.5	62.5
Actuated g/C Ratio	0.36	0.36	0.52	0.52	0.52	0.52
Clearance Time (s)	7.5	7.5	6.7	6.7	6.7	6.7
Vehicle Extension (s)	3.0	3.0	3.0	3.0	3.0	3.0
Lane Grp Cap (vph)	542	485	931	654	315	897
v/s Ratio Prot	c0.32		c0.25			0.14
v/s Ratio Perm		0.08		0.14	0.23	
v/c Ratio	0.88	0.22	0.48	0.28	0.44	0.27
Uniform Delay, d1	35.8	26.6	18.3	16.1	17.9	16.0
Progression Factor	1.00	1.00	0.86	0.91	0.85	0.81
Incremental Delay, d2	14.7	0.2	1.1	0.7	4.4	0.7
Delay (s)	50.6	26.8	17.0	15.3	19.7	13.8
Level of Service	D	C	B	B	B	B
Approach Delay (s)	41.5		16.4			15.9
Approach LOS	D		B			B

Intersection Summary

HCM 2000 Control Delay	26.8	HCM 2000 Level of Service	C
HCM 2000 Volume to Capacity ratio	0.64		
Actuated Cycle Length (s)	120.0	Sum of lost time (s)	14.2
Intersection Capacity Utilization	77.2%	ICU Level of Service	D
Analysis Period (min)	15		

c Critical Lane Group

HCM Unsignalized Intersection Capacity Analysis
 24: Mayfield Road & Triangle Lands













Future Total (2033) -Optimized
 PM Peak Hour



Movement	EBL	EBT	WBT	WBR	SBL	SBR	
Lane Configurations							
Traffic Volume (veh/h)	85	991	995	57	75	167	
Future Volume (Veh/h)	85	991	995	57	75	167	
Sign Control		Free	Free		Stop		
Grade		0%	0%		0%		
Peak Hour Factor	1.00	1.00	1.00	1.00	1.00	1.00	
Hourly flow rate (vph)	85	991	995	57	75	167	
Pedestrians							
Lane Width (m)							
Walking Speed (m/s)							
Percent Blockage							
Right turn flare (veh)							
Median type		None	None				
Median storage (veh)							
Upstream signal (m)			314				
pX, platoon unblocked	0.85				0.85	0.85	
vC, conflicting volume	1052				1689	526	
vC1, stage 1 conf vol							
vC2, stage 2 conf vol							
vCu, unblocked vol	712				1460	94	
tC, single (s)	4.4				7.1	7.2	
tC, 2 stage (s)							
tF (s)	2.3				3.6	3.4	
p0 queue free %	88				5	78	
cM capacity (veh/h)	688				79	772	
Direction, Lane #	EB 1	EB 2	EB 3	WB 1	WB 2	SB 1	SB 2
Volume Total	85	496	496	663	389	75	167
Volume Left	85	0	0	0	0	75	0
Volume Right	0	0	0	0	57	0	167
cSH	688	1700	1700	1700	1700	79	772
Volume to Capacity	0.12	0.29	0.29	0.39	0.23	0.95	0.22
Queue Length 95th (m)	3.4	0.0	0.0	0.0	0.0	40.4	6.6
Control Delay (s)	11.0	0.0	0.0	0.0	0.0	178.3	10.9
Lane LOS	B					F	B
Approach Delay (s)	0.9			0.0		62.8	
Approach LOS						F	
Intersection Summary							
Average Delay			6.8				
Intersection Capacity Utilization			48.2%		ICU Level of Service		A
Analysis Period (min)			15				

HCM Unsignalized Intersection Capacity Analysis
 26: Humber Station Road & Subject Lands Site Access #3

Future Total (2033) -Optimized
 PM Peak Hour

						
Movement	WBL	WBR	NBT	NBR	SBL	SBT
Lane Configurations						
Traffic Volume (veh/h)	88	54	683	54	30	287
Future Volume (Veh/h)	88	54	683	54	30	287
Sign Control	Stop		Free		Free	
Grade	0%		0%		0%	
Peak Hour Factor	1.00	1.00	1.00	1.00	1.00	1.00
Hourly flow rate (vph)	88	54	683	54	30	287
Pedestrians						
Lane Width (m)						
Walking Speed (m/s)						
Percent Blockage						
Right turn flare (veh)						
Median type	None			None		
Median storage veh						
Upstream signal (m)						
pX, platoon unblocked						
vC, conflicting volume	1030	683			737	
vC1, stage 1 conf vol						
vC2, stage 2 conf vol						
vCu, unblocked vol	1030	683			737	
tC, single (s)	6.5	6.4			4.2	
tC, 2 stage (s)						
tF (s)	3.6	3.4			2.3	
p0 queue free %	63	87			96	
cM capacity (veh/h)	237	428			821	
Direction, Lane #	WB 1	WB 2	NB 1	NB 2	SB 1	SB 2
Volume Total	88	54	683	54	30	287
Volume Left	88	0	0	0	30	0
Volume Right	0	54	0	54	0	0
cSH	237	428	1700	1700	821	1700
Volume to Capacity	0.37	0.13	0.40	0.03	0.04	0.17
Queue Length 95th (m)	13.1	3.4	0.0	0.0	0.9	0.0
Control Delay (s)	29.0	14.6	0.0	0.0	9.6	0.0
Lane LOS	D	B			A	
Approach Delay (s)	23.5		0.0	0.9		
Approach LOS	C					
Intersection Summary						
Average Delay			3.0			
Intersection Capacity Utilization			47.5%	ICU Level of Service		A
Analysis Period (min)			15			

HCM Unsignalized Intersection Capacity Analysis
 27: Subject Lands Site Access #4 & Healey Road



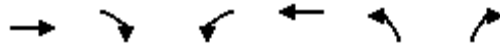









Future Total (2033) -Optimized
 PM Peak Hour



Movement	EBT	EBR	WBL	WBT	NBL	NBR
Lane Configurations	↩			↩	↩	↩
Traffic Volume (veh/h)	658	42	38	907	73	63
Future Volume (Veh/h)	658	42	38	907	73	63
Sign Control	Free			Free	Stop	
Grade	0%			0%	0%	
Peak Hour Factor	1.00	1.00	1.00	1.00	1.00	1.00
Hourly flow rate (vph)	658	42	38	907	73	63
Pedestrians						
Lane Width (m)						
Walking Speed (m/s)						
Percent Blockage						
Right turn flare (veh)						
Median type	None			None		
Median storage veh)						
Upstream signal (m)						
pX, platoon unblocked						
vC, conflicting volume			700		1662	679
vC1, stage 1 conf vol						
vC2, stage 2 conf vol						
vCu, unblocked vol			700		1662	679
tC, single (s)			4.2		6.5	6.3
tC, 2 stage (s)						
tF (s)			2.3		3.6	3.4
p0 queue free %			96		23	85
cM capacity (veh/h)			848		95	431
Direction, Lane #	EB 1	WB 1	NB 1	NB 2		
Volume Total	700	945	73	63		
Volume Left	0	38	73	0		
Volume Right	42	0	0	63		
cSH	1700	848	95	431		
Volume to Capacity	0.41	0.04	0.77	0.15		
Queue Length 95th (m)	0.0	1.1	32.1	4.1		
Control Delay (s)	0.0	1.3	115.5	14.8		
Lane LOS		A	F	B		
Approach Delay (s)	0.0	1.3	68.8			
Approach LOS			F			
Intersection Summary						
Average Delay			5.9			
Intersection Capacity Utilization			89.3%	ICU Level of Service		E
Analysis Period (min)			15			

HCM Unsignalized Intersection Capacity Analysis
 28: Humber Station Road & Subject Lands Site Access #2

Future Total (2033) -Optimized
 PM Peak Hour

						
Movement	WBL	WBR	NBT	NBR	SBL	SBT
Lane Configurations						
Traffic Volume (veh/h)	7	5	732	5	2	373
Future Volume (Veh/h)	7	5	732	5	2	373
Sign Control	Stop		Free		Free	
Grade	0%		0%		0%	
Peak Hour Factor	1.00	1.00	1.00	1.00	1.00	1.00
Hourly flow rate (vph)	7	5	732	5	2	373
Pedestrians						
Lane Width (m)						
Walking Speed (m/s)						
Percent Blockage						
Right turn flare (veh)						
Median type	None			None		
Median storage (veh)						
Upstream signal (m)						
pX, platoon unblocked						
vC, conflicting volume	1109	732			737	
vC1, stage 1 conf vol						
vC2, stage 2 conf vol						
vCu, unblocked vol	1109	732			737	
tC, single (s)	6.5	6.4			4.1	
tC, 2 stage (s)						
tF (s)	3.6	3.5			2.2	
p0 queue free %	97	99			100	
cM capacity (veh/h)	219	393			878	
Direction, Lane #	WB 1	WB 2	NB 1	NB 2	SB 1	SB 2
Volume Total	7	5	732	5	2	373
Volume Left	7	0	0	0	2	0
Volume Right	0	5	0	5	0	0
cSH	219	393	1700	1700	878	1700
Volume to Capacity	0.03	0.01	0.43	0.00	0.00	0.22
Queue Length 95th (m)	0.8	0.3	0.0	0.0	0.1	0.0
Control Delay (s)	22.0	14.3	0.0	0.0	9.1	0.0
Lane LOS	C	B			A	
Approach Delay (s)	18.8		0.0		0.0	
Approach LOS	C					
Intersection Summary						
Average Delay			0.2			
Intersection Capacity Utilization			48.5%		ICU Level of Service	A
Analysis Period (min)			15			

HCM Unsignalized Intersection Capacity Analysis
 29: Mayfield Road & Subject Lands Site Access #5

Future Total (2033) -Optimized
 PM Peak Hour



Movement	EBL	EBT	WBT	WBR	SBL	SBR	
Lane Configurations							
Traffic Volume (veh/h)	14	1065	1156	6	11	23	
Future Volume (Veh/h)	14	1065	1156	6	11	23	
Sign Control		Free	Free		Stop		
Grade		0%	0%		0%		
Peak Hour Factor	1.00	1.00	1.00	1.00	1.00	1.00	
Hourly flow rate (vph)	14	1065	1156	6	11	23	
Pedestrians							
Lane Width (m)							
Walking Speed (m/s)							
Percent Blockage							
Right turn flare (veh)							
Median type		None	None				
Median storage veh							
Upstream signal (m)		262					
pX, platoon unblocked					0.87		
vC, conflicting volume	1162				1720	581	
vC1, stage 1 conf vol							
vC2, stage 2 conf vol							
vCu, unblocked vol	1162				1525	581	
tC, single (s)	4.1				6.8	6.9	
tC, 2 stage (s)							
tF (s)	2.2				3.5	3.3	
p0 queue free %	98				88	95	
cM capacity (veh/h)	608				94	462	
Direction, Lane #	EB 1	EB 2	EB 3	WB 1	WB 2	SB 1	SB 2
Volume Total	14	532	532	771	391	11	23
Volume Left	14	0	0	0	0	11	0
Volume Right	0	0	0	0	6	0	23
cSH	608	1700	1700	1700	1700	94	462
Volume to Capacity	0.02	0.31	0.31	0.45	0.23	0.12	0.05
Queue Length 95th (m)	0.6	0.0	0.0	0.0	0.0	3.1	1.3
Control Delay (s)	11.1	0.0	0.0	0.0	0.0	48.4	13.2
Lane LOS	B					E	B
Approach Delay (s)	0.1			0.0		24.6	
Approach LOS						C	
Intersection Summary							
Average Delay			0.4				
Intersection Capacity Utilization			42.1%		ICU Level of Service		A
Analysis Period (min)			15				

Queues
1: Coleraine Drive & Healey Road

Future Total (2043) - Optimized
AM Peak Hour



Lane Group	EBL	EBT	WBL	WBT	NBL	NBT	SBL	SBT
Lane Configurations	↶	↷	↶	↷	↶	↷	↶	↷
Traffic Volume (vph)	247	540	98	241	72	188	64	385
Future Volume (vph)	247	540	98	241	72	188	64	385
Lane Group Flow (vph)	266	867	105	283	77	240	69	695
Turn Type	pm+pt	NA	pm+pt	NA	pm+pt	NA	Perm	NA
Protected Phases	3	8	7	4	1	6		2
Permitted Phases	8		4		6		2	
Detector Phase	3	8	7	4	1	6	2	2
Switch Phase								
Minimum Initial (s)	5.0	8.0	5.0	8.0	5.0	8.0	8.0	8.0
Minimum Split (s)	8.0	32.8	8.0	32.8	9.5	36.7	36.7	36.7
Total Split (s)	8.0	65.0	8.0	65.0	10.0	47.0	37.0	37.0
Total Split (%)	6.7%	54.2%	6.7%	54.2%	8.3%	39.2%	30.8%	30.8%
Yellow Time (s)	3.0	4.0	3.0	4.0	3.0	4.6	4.6	4.6
All-Red Time (s)	0.0	2.8	0.0	2.8	0.0	2.1	2.1	2.1
Lost Time Adjust (s)	0.0	0.0	0.0	0.0	0.0	0.0	0.0	0.0
Total Lost Time (s)	3.0	6.8	3.0	6.8	3.0	6.7	6.7	6.7
Lead/Lag	Lead	Lag	Lead	Lag	Lead		Lag	Lag
Lead-Lag Optimize?	Yes	Yes	Yes	Yes	Yes		Yes	Yes
Recall Mode	None	None	None	None	None	C-Max	C-Max	C-Max
v/c Ratio	0.49	1.00	0.90	0.34	0.43	0.25	0.31	0.76
Control Delay	10.2	45.7	80.6	20.1	32.8	27.3	41.0	39.2
Queue Delay	0.0	0.0	0.0	0.0	0.0	0.0	0.0	0.0
Total Delay	10.2	45.7	80.6	20.1	32.8	27.3	41.0	39.2
Queue Length 50th (m)	10.0	-156.2	11.3	41.2	12.6	20.6	14.0	70.1
Queue Length 95th (m)	m29.0	#297.3	#46.5	62.1	23.9	31.5	28.7	94.4
Internal Link Dist (m)		823.7		424.0		1711.9		1121.0
Turn Bay Length (m)	55.0		50.0		80.0		155.0	
Base Capacity (vph)	546	867	117	838	183	946	224	912
Starvation Cap Reductn	0	0	0	0	0	0	0	0
Spillback Cap Reductn	0	0	0	0	0	0	0	0
Storage Cap Reductn	0	0	0	0	0	0	0	0
Reduced v/c Ratio	0.49	1.00	0.90	0.34	0.42	0.25	0.31	0.76

Intersection Summary





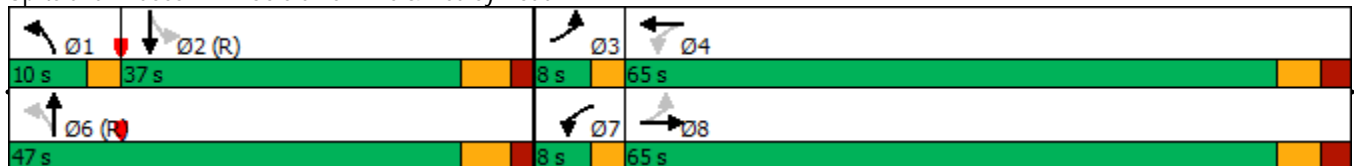

















Cycle Length: 120
 Actuated Cycle Length: 120
 Offset: 13 (11%), Referenced to phase 2:SBTL and 6:NBTL, Start of Green
 Natural Cycle: 110
 Control Type: Actuated-Coordinated
 ~ Volume exceeds capacity, queue is theoretically infinite.
 Queue shown is maximum after two cycles.
 # 95th percentile volume exceeds capacity, queue may be longer.
 Queue shown is maximum after two cycles.
 m Volume for 95th percentile queue is metered by upstream signal.

Splits and Phases: 1: Coleraine Drive & Healey Road



HCM Signalized Intersection Capacity Analysis
1: Coleraine Drive & Healey Road

Future Total (2043) - Optimized
AM Peak Hour

													
Movement	EBL	EBT	EBR	WBL	WBT	WBR	NBL	NBT	NBR	SBL	SBT	SBR	
Lane Configurations													
Traffic Volume (vph)	247	540	266	98	241	22	72	188	35	64	385	261	
Future Volume (vph)	247	540	266	98	241	22	72	188	35	64	385	261	
Ideal Flow (vphpl)	1900	1900	1900	1900	1900	1900	1900	1900	1900	1900	1900	1900	
Lane Width	3.0	3.5	3.0	3.0	3.5	3.0	3.0	3.5	3.0	3.0	3.5	3.0	
Total Lost time (s)	3.0	6.8		3.0	6.8		3.0	6.7		6.7	6.7		
Lane Util. Factor	1.00	1.00		1.00	1.00		1.00	0.95		1.00	0.95		
Frt	1.00	0.95		1.00	0.99		1.00	0.98		1.00	0.94		
Flt Protected	0.95	1.00		0.95	1.00		0.95	1.00		0.95	1.00		
Satd. Flow (prot)	1636	1757		1491	1724		1589	2779		1316	3033		
Flt Permitted	0.54	1.00		0.07	1.00		0.18	1.00		0.60	1.00		
Satd. Flow (perm)	927	1757		108	1724		297	2779		835	3033		
Peak-hour factor, PHF	0.93	0.93	0.93	0.93	0.93	0.93	0.93	0.93	0.93	0.93	0.93	0.93	
Adj. Flow (vph)	266	581	286	105	259	24	77	202	38	69	414	281	
RTOR Reduction (vph)	0	15	0	0	3	0	0	13	0	0	98	0	
Lane Group Flow (vph)	266	852	0	105	280	0	77	227	0	69	597	0	
Heavy Vehicles (%)	3%	1%	3%	13%	2%	68%	6%	27%	17%	28%	15%	4%	
Turn Type	pm+pt	NA		pm+pt	NA		pm+pt	NA		Perm	NA		
Protected Phases	3	8		7	4		1	6			2		
Permitted Phases	8			4			6			2			
Actuated Green, G (s)	63.2	58.2		63.2	58.2		40.3	40.3		31.7	31.7		
Effective Green, g (s)	63.2	58.2		63.2	58.2		40.3	40.3		31.7	31.7		
Actuated g/C Ratio	0.53	0.49		0.53	0.49		0.34	0.34		0.26	0.26		
Clearance Time (s)	3.0	6.8		3.0	6.8		3.0	6.7		6.7	6.7		
Vehicle Extension (s)	3.0	3.0		3.0	3.0		3.0	3.0		3.0	3.0		
Lane Grp Cap (vph)	517	852		114	836		160	933		220	801		
v/s Ratio Prot	0.02	c0.49		c0.04	0.16		c0.02	0.08			c0.20		
v/s Ratio Perm	0.25			0.45			0.14			0.08			
v/c Ratio	0.51	1.00		0.92	0.34		0.48	0.24		0.31	0.75		
Uniform Delay, d1	18.5	30.9		26.7	19.0		29.5	28.8		35.4	40.5		
Progression Factor	0.56	0.64		1.00	1.00		1.00	1.00		1.00	1.00		
Incremental Delay, d2	0.6	25.1		59.8	0.2		2.3	0.6		3.7	6.2		
Delay (s)	11.0	44.8		86.5	19.2		31.8	29.4		39.1	46.7		
Level of Service	B	D		F	B		C	C		D	D		
Approach Delay (s)		36.8			37.5			30.0			46.0		
Approach LOS		D			D			C			D		
Intersection Summary													
HCM 2000 Control Delay			38.8									HCM 2000 Level of Service	D
HCM 2000 Volume to Capacity ratio			0.89										
Actuated Cycle Length (s)			120.0									Sum of lost time (s)	19.5
Intersection Capacity Utilization			91.2%									ICU Level of Service	F
Analysis Period (min)			15										

c Critical Lane Group

Queues
2: Humber Station Road & Healey Road

Future Total (2043) - Optimized
AM Peak Hour

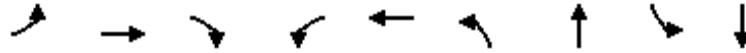

Lane Group	EBL	EBT	EBR	WBL	WBT	NBL	NBT	SBL	SBT
Lane Configurations	↶	↷	↶	↶	↷	↶	↷	↶	↷
Traffic Volume (vph)	4	962	163	184	479	83	24	82	233
Future Volume (vph)	4	962	163	184	479	83	24	82	233
Lane Group Flow (vph)	4	1034	175	198	519	89	172	88	255
Turn Type	Perm	NA	Perm	pm+pt	NA	Perm	NA	Perm	NA
Protected Phases		4		3	8		2		6
Permitted Phases	4		4	8		2		6	
Detector Phase	4	4	4	3	8	2	2	6	6
Switch Phase									
Minimum Initial (s)	8.0	8.0	8.0	5.0	8.0	8.0	8.0	5.0	5.0
Minimum Split (s)	24.8	24.8	24.8	9.5	24.8	24.7	24.7	24.8	24.8
Total Split (s)	65.0	65.0	65.0	25.0	90.0	30.0	30.0	30.0	30.0
Total Split (%)	54.2%	54.2%	54.2%	20.8%	75.0%	25.0%	25.0%	25.0%	25.0%
Yellow Time (s)	4.0	4.0	4.0	3.0	4.0	4.6	4.6	4.6	4.6
All-Red Time (s)	2.8	2.8	2.8	0.0	2.8	2.1	2.1	2.1	2.1
Lost Time Adjust (s)	0.0	0.0	0.0	0.0	0.0	0.0	0.0	0.0	0.0
Total Lost Time (s)	6.8	6.8	6.8	3.0	6.8	6.7	6.7	6.7	6.7
Lead/Lag	Lag	Lag	Lag	Lead					
Lead-Lag Optimize?	Yes	Yes	Yes	Yes					
Recall Mode	None	None	None	None	None	C-Max	C-Max	C-Max	C-Max
v/c Ratio	0.01	1.02	0.22	0.77	0.40	0.81	0.41	0.47	0.71
Control Delay	15.2	62.3	10.8	55.2	6.5	88.4	8.7	52.0	56.8
Queue Delay	0.0	0.0	0.0	0.0	0.0	0.0	0.0	0.0	0.0
Total Delay	15.2	62.3	10.8	55.2	6.5	88.4	8.7	52.0	56.8
Queue Length 50th (m)	0.4	-272.3	13.4	33.4	24.1	22.0	3.1	19.5	59.4
Queue Length 95th (m)	2.6	#382.2	30.1	56.5	57.1	#52.3	9.4	37.4	89.5
Internal Link Dist (m)		465.5			505.1		463.9		452.2
Turn Bay Length (m)	30.0		30.0	60.0		30.0		30.0	
Base Capacity (vph)	364	1012	801	344	1286	110	418	189	361
Starvation Cap Reductn	0	0	0	0	0	0	0	0	0
Spillback Cap Reductn	0	0	0	0	0	0	0	0	0
Storage Cap Reductn	0	0	0	0	0	0	0	0	0
Reduced v/c Ratio	0.01	1.02	0.22	0.58	0.40	0.81	0.41	0.47	0.71

Intersection Summary

Cycle Length: 120
 Actuated Cycle Length: 120
 Offset: 43 (36%), Referenced to phase 2:NBTL and 6:SBTL, Start of Green
 Natural Cycle: 100
 Control Type: Actuated-Coordinated
 ~ Volume exceeds capacity, queue is theoretically infinite.
 Queue shown is maximum after two cycles.
 # 95th percentile volume exceeds capacity, queue may be longer.
 Queue shown is maximum after two cycles.



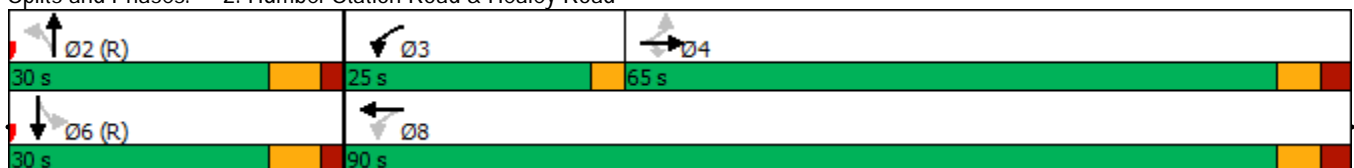



















Splits and Phases: 2: Humber Station Road & Healey Road



HCM Signalized Intersection Capacity Analysis

2: Humber Station Road & Healey Road

Future Total (2043) - Optimized
AM Peak Hour

												
Movement	EBL	EBT	EBR	WBL	WBT	WBR	NBL	NBT	NBR	SBL	SBT	SBR
Lane Configurations												
Traffic Volume (vph)	4	962	163	184	479	4	83	24	136	82	233	4
Future Volume (vph)	4	962	163	184	479	4	83	24	136	82	233	4
Ideal Flow (vphpl)	1900	1900	1900	1900	1900	1900	1900	1900	1900	1900	1900	1900
Lane Width	3.0	3.5	3.0	3.0	3.5	3.0	3.0	3.5	3.0	3.0	3.5	3.0
Total Lost time (s)	6.8	6.8	6.8	3.0	6.8		6.7	6.7		6.7	6.7	
Lane Util. Factor	1.00	1.00	1.00	1.00	1.00		1.00	1.00		1.00	1.00	
Frt	1.00	1.00	0.85	1.00	1.00		1.00	0.87		1.00	1.00	
Flt Protected	0.95	1.00	1.00	0.95	1.00		0.95	1.00		0.95	1.00	
Satd. Flow (prot)	1348	1860	1422	1589	1855		1491	1548		1685	1856	
Flt Permitted	0.47	1.00	1.00	0.06	1.00		0.36	1.00		0.55	1.00	
Satd. Flow (perm)	669	1860	1422	98	1855		569	1548		976	1856	
Peak-hour factor, PHF	0.93	0.93	0.93	0.93	0.93	0.93	0.93	0.93	0.93	0.93	0.93	0.93
Adj. Flow (vph)	4	1034	175	198	515	4	89	26	146	88	251	4
RTOR Reduction (vph)	0	0	28	0	0	0	0	118	0	0	1	0
Lane Group Flow (vph)	4	1034	147	198	519	0	89	54	0	88	254	0
Heavy Vehicles (%)	25%	1%	6%	6%	1%	25%	13%	0%	7%	0%	1%	0%
Turn Type	Perm	NA	Perm	pm+pt	NA		Perm	NA		Perm	NA	
Protected Phases		4		3	8			2			6	
Permitted Phases	4		4	8			2			6		
Actuated Green, G (s)	65.3	65.3	65.3	83.2	83.2		23.3	23.3		23.3	23.3	
Effective Green, g (s)	65.3	65.3	65.3	83.2	83.2		23.3	23.3		23.3	23.3	
Actuated g/C Ratio	0.54	0.54	0.54	0.69	0.69		0.19	0.19		0.19	0.19	
Clearance Time (s)	6.8	6.8	6.8	3.0	6.8		6.7	6.7		6.7	6.7	
Vehicle Extension (s)	3.0	3.0	3.0	3.0	3.0		3.0	3.0		3.0	3.0	
Lane Grp Cap (vph)	364	1012	773	253	1286		110	300		189	360	
v/s Ratio Prot		c0.56		c0.10	0.28			0.04			0.14	
v/s Ratio Perm	0.01		0.10	0.45			c0.16			0.09		
v/c Ratio	0.01	1.02	0.19	0.78	0.40		0.81	0.18		0.47	0.71	
Uniform Delay, d1	12.5	27.4	13.9	38.1	7.8		46.2	40.4		42.8	45.2	
Progression Factor	1.00	1.00	1.00	1.32	0.70		0.88	0.57		1.00	1.00	
Incremental Delay, d2	0.0	33.9	0.1	13.9	0.2		45.2	1.3		8.0	11.1	
Delay (s)	12.6	61.3	14.0	64.1	5.7		85.8	24.5		50.9	56.2	
Level of Service	B	E	B	E	A		F	C		D	E	
Approach Delay (s)		54.3			21.8			45.4			54.9	
Approach LOS		D			C			D			D	

Intersection Summary

HCM 2000 Control Delay	44.3	HCM 2000 Level of Service	D
HCM 2000 Volume to Capacity ratio	0.94		
Actuated Cycle Length (s)	120.0	Sum of lost time (s)	16.5
Intersection Capacity Utilization	100.2%	ICU Level of Service	G
Analysis Period (min)	15		

c Critical Lane Group

Queues

Future Total (2043) - Optimized

3: Clarkway Drive/Humber Station Road & Mayfield Road

AM Peak Hour

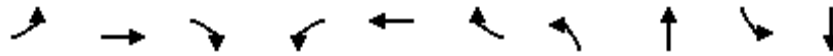

Lane Group	EBL	EBT	EBR	WBL	WBT	WBR	NBL	NBT	SBL	SBT
Lane Configurations	↙	↑↑↑	↘	↙	↑↑↑	↘	↙	↑	↘	↘
Traffic Volume (vph)	312	1978	28	62	789	112	11	171	66	336
Future Volume (vph)	312	1978	28	62	789	112	11	171	66	336
Lane Group Flow (vph)	325	2060	29	65	822	117	11	306	69	458
Turn Type	pm+pt	NA	Perm	pm+pt	NA	Perm	Perm	NA	Perm	NA
Protected Phases	5	2		1	6			4		8
Permitted Phases	2		2	6		6	4		8	
Detector Phase	5	2	2	1	6	6	4	4	8	8
Switch Phase										
Minimum Initial (s)	5.0	12.0	12.0	5.0	12.0	12.0	8.0	8.0	8.0	8.0
Minimum Split (s)	9.5	27.3	27.3	9.5	27.5	27.5	26.0	26.0	27.5	27.5
Total Split (s)	20.0	60.0	60.0	10.0	50.0	50.0	50.0	50.0	50.0	50.0
Total Split (%)	16.7%	50.0%	50.0%	8.3%	41.7%	41.7%	41.7%	41.7%	41.7%	41.7%
Yellow Time (s)	3.0	4.6	4.6	3.0	4.6	4.6	4.2	4.2	4.2	4.2
All-Red Time (s)	0.0	2.7	2.7	0.0	2.7	2.7	2.8	2.8	2.8	2.8
Lost Time Adjust (s)	0.0	0.0	0.0	0.0	0.0	0.0	0.0	0.0	0.0	0.0
Total Lost Time (s)	3.0	7.3	7.3	3.0	7.3	7.3	7.0	7.0	7.0	7.0
Lead/Lag	Lead	Lag	Lag	Lead	Lag	Lag				
Lead-Lag Optimize?	Yes	Yes	Yes	Yes	Yes	Yes				
Recall Mode	None	C-Max	C-Max	None	C-Max	C-Max	None	None	None	None
v/c Ratio	0.76	0.83	0.04	0.44	0.44	0.18	0.13	0.59	0.35	0.87
Control Delay	25.5	30.3	0.5	27.2	24.2	4.1	31.5	35.5	40.0	60.2
Queue Delay	0.0	0.0	0.0	0.0	0.0	0.0	0.0	0.0	0.0	0.0
Total Delay	25.5	30.3	0.5	27.2	24.2	4.1	31.5	35.5	40.0	60.2
Queue Length 50th (m)	37.0	161.9	0.0	5.8	45.5	0.0	2.0	56.7	15.4	114.3
Queue Length 95th (m)	#74.3	#219.0	0.8	18.6	54.4	8.6	6.7	80.1	29.5	151.2
Internal Link Dist (m)		1635.6			240.8			1187.5		1542.4
Turn Bay Length (m)	150.0		105.0	150.0		115.0			105.0	
Base Capacity (vph)	441	2484	650	153	1881	657	105	622	234	628
Starvation Cap Reductn	0	0	0	0	0	0	0	0	0	0
Spillback Cap Reductn	0	0	0	0	0	0	0	0	0	0
Storage Cap Reductn	0	0	0	0	0	0	0	0	0	0
Reduced v/c Ratio	0.74	0.83	0.04	0.42	0.44	0.18	0.10	0.49	0.29	0.73

Intersection Summary

Cycle Length: 120
 Actuated Cycle Length: 120
 Offset: 46 (38%), Referenced to phase 2:EBTL and 6:WBTL, Start of Green
 Natural Cycle: 90
 Control Type: Actuated-Coordinated
 # 95th percentile volume exceeds capacity, queue may be longer.
 Queue shown is maximum after two cycles.

Splits and Phases: 3: Clarkway Drive/Humber Station Road & Mayfield Road

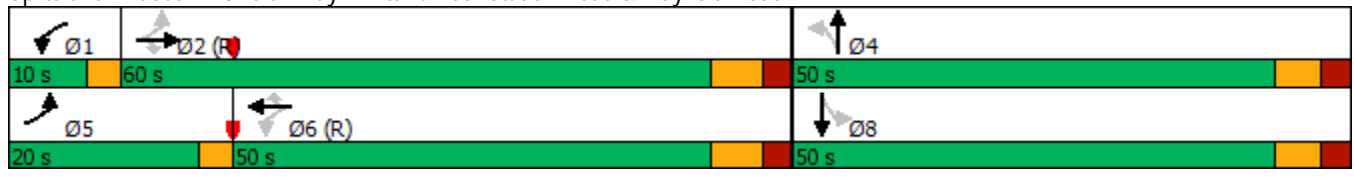

HCM Signalized Intersection Capacity Analysis

3: Clarkway Drive/Humber Station Road & Mayfield Road

Future Total (2043) - Optimized
AM Peak Hour



Movement	EBL	EBT	EBR	WBL	WBT	WBR	NBL	NBT	NBR	SBL	SBT	SBR
Lane Configurations	↗	↑↑↑	↖	↗	↑↑↑	↖	↗	↖		↗	↖	
Traffic Volume (vph)	312	1978	28	62	789	112	11	171	123	66	336	104
Future Volume (vph)	312	1978	28	62	789	112	11	171	123	66	336	104
Ideal Flow (vphpl)	1900	1900	1900	1900	1900	1900	1900	1900	1900	1900	1900	1900
Lane Width	3.0	3.5	3.0	3.0	3.5	3.0	3.0	3.5	3.0	3.0	3.5	3.0
Total Lost time (s)	3.0	7.3	7.3	3.0	7.3	7.3	7.0	7.0		7.0	7.0	
Lane Util. Factor	1.00	0.91	1.00	1.00	0.91	1.00	1.00	1.00		1.00	1.00	
Frt	1.00	1.00	0.85	1.00	1.00	0.85	1.00	0.94		1.00	0.96	
Flt Protected	0.95	1.00	1.00	0.95	1.00	1.00	0.95	1.00		0.95	1.00	
Satd. Flow (prot)	1560	4839	1206	1532	4499	1409	1428	1677		1518	1729	
Flt Permitted	0.27	1.00	1.00	0.08	1.00	1.00	0.20	1.00		0.41	1.00	
Satd. Flow (perm)	443	4839	1206	128	4499	1409	295	1677		654	1729	
Peak-hour factor, PHF	0.96	0.96	0.96	0.96	0.96	0.96	0.96	0.96	0.96	0.96	0.96	0.96
Adj. Flow (vph)	325	2060	29	65	822	117	11	178	128	69	350	108
RTOR Reduction (vph)	0	0	14	0	0	68	0	24	0	0	10	0
Lane Group Flow (vph)	325	2060	15	65	822	49	11	282	0	69	448	0
Heavy Vehicles (%)	8%	6%	25%	10%	14%	7%	18%	5%	5%	11%	2%	14%
Turn Type	pm+pt	NA	Perm	pm+pt	NA	Perm	Perm	NA		Perm	NA	
Protected Phases	5	2		1	6			4			8	
Permitted Phases	2		2	6		6	4			8		
Actuated Green, G (s)	69.9	61.0	61.0	56.1	50.2	50.2	35.8	35.8		35.8	35.8	
Effective Green, g (s)	69.9	61.0	61.0	56.1	50.2	50.2	35.8	35.8		35.8	35.8	
Actuated g/C Ratio	0.58	0.51	0.51	0.47	0.42	0.42	0.30	0.30		0.30	0.30	
Clearance Time (s)	3.0	7.3	7.3	3.0	7.3	7.3	7.0	7.0		7.0	7.0	
Vehicle Extension (s)	3.0	3.0	3.0	3.0	3.0	3.0	3.0	3.0		3.0	3.0	
Lane Grp Cap (vph)	413	2459	613	128	1882	589	88	500		195	515	
v/s Ratio Prot	c0.11	c0.43		0.02	0.18			0.17			c0.26	
v/s Ratio Perm	0.35		0.01	0.21		0.03	0.04			0.11		
v/c Ratio	0.79	0.84	0.02	0.51	0.44	0.08	0.12	0.56		0.35	0.87	
Uniform Delay, d1	14.2	25.3	14.7	21.1	24.8	21.0	30.7	35.5		33.0	39.9	
Progression Factor	1.00	1.00	1.00	1.14	0.89	0.73	1.00	1.00		1.11	1.12	
Incremental Delay, d2	9.5	3.6	0.1	3.1	0.7	0.3	0.6	1.5		1.1	14.5	
Delay (s)	23.7	28.9	14.8	27.2	22.7	15.5	31.3	37.0		37.7	59.1	
Level of Service	C	C	B	C	C	B	C	D		D	E	
Approach Delay (s)		28.0			22.2			36.8			56.3	
Approach LOS		C			C			D			E	

Intersection Summary

HCM 2000 Control Delay	30.8	HCM 2000 Level of Service	C
HCM 2000 Volume to Capacity ratio	0.86		
Actuated Cycle Length (s)	120.0	Sum of lost time (s)	17.3
Intersection Capacity Utilization	94.1%	ICU Level of Service	F
Analysis Period (min)	15		

c Critical Lane Group

Queues

Future Total (2043) - Optimized

4: Coleraine Drive & Mayfield Road

AM Peak Hour

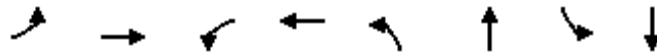

Lane Group	EBL	EBT	WBL	WBT	NBL	NBT	SBL	SBT
Lane Configurations	↖	↑↑↓	↖	↑↑	↖	↑↓	↖	↑↓
Traffic Volume (vph)	555	718	44	834	10	180	99	339
Future Volume (vph)	555	718	44	834	10	180	99	339
Lane Group Flow (vph)	631	844	50	1111	11	215	113	699
Turn Type	pm+pt	NA	Perm	NA	Perm	NA	Perm	NA
Protected Phases	5	2		6		4		8
Permitted Phases	2		6		4		8	
Detector Phase	5	2	6	6	4	4	8	8
Switch Phase								
Minimum Initial (s)	5.0	12.0	12.0	12.0	12.0	12.0	12.0	12.0
Minimum Split (s)	8.0	37.0	37.0	37.0	37.0	37.0	37.0	37.0
Total Split (s)	44.0	93.0	49.0	49.0	37.0	37.0	37.0	37.0
Total Split (%)	33.8%	71.5%	37.7%	37.7%	28.5%	28.5%	28.5%	28.5%
Yellow Time (s)	3.0	4.6	4.6	4.6	4.2	4.2	4.2	4.2
All-Red Time (s)	0.0	2.4	2.4	2.4	2.8	2.8	2.8	2.8
Lost Time Adjust (s)	0.0	0.0	0.0	0.0	0.0	0.0	0.0	0.0
Total Lost Time (s)	3.0	7.0	7.0	7.0	7.0	7.0	7.0	7.0
Lead/Lag	Lead		Lag	Lag				
Lead-Lag Optimize?	Yes		Yes	Yes				
Recall Mode	None	C-Max	C-Max	C-Max	None	None	None	None
v/c Ratio	1.07	0.27	0.27	1.04	0.24	0.28	0.56	0.89
Control Delay	93.0	8.7	37.7	79.4	56.4	42.6	56.6	53.3
Queue Delay	0.0	0.0	0.0	0.0	0.0	0.0	0.0	0.0
Total Delay	93.0	8.7	37.7	79.4	56.4	42.6	56.6	53.3
Queue Length 50th (m)	~180.2	31.6	10.0	~167.8	2.4	24.7	26.8	76.9
Queue Length 95th (m)	#245.7	37.3	21.6	#204.1	8.8	35.7	46.5	98.3
Internal Link Dist (m)		290.4		195.1		791.2		576.8
Turn Bay Length (m)	100.0		85.0		105.0		145.0	
Base Capacity (vph)	588	3126	184	1073	48	816	217	833
Starvation Cap Reductn	0	0	0	0	0	0	0	0
Spillback Cap Reductn	0	0	0	0	0	0	0	0
Storage Cap Reductn	0	0	0	0	0	0	0	0
Reduced v/c Ratio	1.07	0.27	0.27	1.04	0.23	0.26	0.52	0.84

Intersection Summary

Cycle Length: 130
 Actuated Cycle Length: 130
 Offset: 92 (71%), Referenced to phase 2:EBTL and 6:WBTL, Start of Green
 Natural Cycle: 145
 Control Type: Actuated-Coordinated
 ~ Volume exceeds capacity, queue is theoretically infinite.
 Queue shown is maximum after two cycles.
 # 95th percentile volume exceeds capacity, queue may be longer.
 Queue shown is maximum after two cycles.





















Splits and Phases: 4: Coleraine Drive & Mayfield Road



HCM Signalized Intersection Capacity Analysis

4: Coleraine Drive & Mayfield Road

Future Total (2043) - Optimized
AM Peak Hour

													
Movement	EBL	EBT	EBR	WBL	WBT	WBR	NBL	NBT	NBR	SBL	SBT	SBR	
Lane Configurations													
Traffic Volume (vph)	555	718	25	44	834	143	10	180	9	99	339	276	
Future Volume (vph)	555	718	25	44	834	143	10	180	9	99	339	276	
Ideal Flow (vphpl)	1900	1900	1900	1900	1900	1900	1900	1900	1900	1900	1900	1900	
Lane Width	3.0	3.5	3.0	3.0	3.5	3.0	3.0	3.5	3.0	3.0	3.5	3.0	
Total Lost time (s)	3.0	7.0		7.0	7.0		7.0	7.0		7.0	7.0		
Lane Util. Factor	1.00	0.91		1.00	0.95		1.00	0.95		1.00	0.95		
Fr't	1.00	1.00		1.00	0.98		1.00	0.99		1.00	0.93		
Flt Protected	0.95	1.00		0.95	1.00		0.95	1.00		0.95	1.00		
Satd. Flow (prot)	1604	4608		1685	3288		1404	3527		1452	3119		
Flt Permitted	0.09	1.00		0.32	1.00		0.14	1.00		0.62	1.00		
Satd. Flow (perm)	150	4608		572	3288		212	3527		944	3119		
Peak-hour factor, PHF	0.88	0.88	0.88	0.88	0.88	0.88	0.88	0.88	0.88	0.88	0.88	0.88	
Adj. Flow (vph)	631	816	28	50	948	162	11	205	10	112	385	314	
RTOR Reduction (vph)	0	3	0	0	11	0	0	2	0	0	115	0	
Lane Group Flow (vph)	631	841	0	50	1100	0	11	213	0	113	584	0	
Heavy Vehicles (%)	5%	11%	4%	0%	5%	13%	20%	0%	11%	16%	0%	15%	
Turn Type	pm+pt	NA		Perm	NA		Perm	NA		Perm	NA		
Protected Phases	5	2			6			4			8		
Permitted Phases	2			6			4			8			
Actuated Green, G (s)	88.1	88.1		42.0	42.0		27.9	27.9		27.9	27.9		
Effective Green, g (s)	88.1	88.1		42.0	42.0		27.9	27.9		27.9	27.9		
Actuated g/C Ratio	0.68	0.68		0.32	0.32		0.21	0.21		0.21	0.21		
Clearance Time (s)	3.0	7.0		7.0	7.0		7.0	7.0		7.0	7.0		
Vehicle Extension (s)	3.0	3.0		3.0	3.0		3.0	3.0		3.0	3.0		
Lane Grp Cap (vph)	583	3122		184	1062		45	756		202	669		
v/s Ratio Prot	c0.36	0.18			0.33			0.06			c0.19		
v/s Ratio Perm	c0.37			0.09			0.05			0.12			
v/c Ratio	1.08	0.27		0.27	1.04		0.24	0.28		0.56	0.87		
Uniform Delay, d1	37.5	8.3		32.7	44.0		42.3	42.7		45.6	49.3		
Progression Factor	1.00	1.00		1.00	1.00		1.00	1.00		1.00	1.00		
Incremental Delay, d2	61.5	0.2		3.6	37.3		2.8	0.2		3.3	12.0		
Delay (s)	99.0	8.5		36.3	81.3		45.1	42.9		48.9	61.4		
Level of Service	F	A		D	F		D	D		D	E		
Approach Delay (s)		47.2			79.4			43.0			59.6		
Approach LOS		D			E			D			E		
Intersection Summary													
HCM 2000 Control Delay			59.9									HCM 2000 Level of Service	E
HCM 2000 Volume to Capacity ratio			1.05										
Actuated Cycle Length (s)			130.0									Sum of lost time (s)	17.0
Intersection Capacity Utilization			107.4%									ICU Level of Service	G
Analysis Period (min)			15										

c Critical Lane Group

Queues

Future Total (2043) - Optimized

5: Coleraine Drive & Private Access/George Bolton Parkway

AM Peak Hour



Lane Group	EBL	EBT	WBL	WBT	NBL	NBT	SBL	SBT	SBR
Lane Configurations	↖	↗	↖	↗	↖	↗	↖	↗	↗
Traffic Volume (vph)	30	35	63	23	213	485	93	499	113
Future Volume (vph)	30	35	63	23	213	485	93	499	113
Lane Group Flow (vph)	35	141	73	191	248	676	108	580	131
Turn Type	Perm	NA	Perm	NA	Perm	NA	Perm	NA	Perm
Protected Phases		8		4		6		2	
Permitted Phases	8		4		6		2		2
Detector Phase	8	8	4	4	6	6	2	2	2
Switch Phase									
Minimum Initial (s)	8.0	8.0	12.0	12.0	12.0	12.0	12.0	12.0	12.0
Minimum Split (s)	32.5	32.5	32.5	32.5	34.2	34.2	33.7	33.7	33.7
Total Split (s)	45.0	45.0	45.0	45.0	55.0	55.0	55.0	55.0	55.0
Total Split (%)	45.0%	45.0%	45.0%	45.0%	55.0%	55.0%	55.0%	55.0%	55.0%
Yellow Time (s)	4.0	4.0	4.0	4.0	4.2	4.2	4.2	4.2	4.2
All-Red Time (s)	3.5	3.5	3.5	3.5	2.5	2.5	2.5	2.5	2.5
Lost Time Adjust (s)	0.0	0.0	0.0	0.0	0.0	0.0	0.0	0.0	0.0
Total Lost Time (s)	7.5	7.5	7.5	7.5	6.7	6.7	6.7	6.7	6.7
Lead/Lag									
Lead-Lag Optimize?									
Recall Mode	None	None	None	None	C-Max	C-Max	C-Max	C-Max	C-Max
v/c Ratio	0.28	0.48	0.54	0.54	0.50	0.31	0.23	0.26	0.13
Control Delay	42.0	18.5	53.9	14.5	11.9	6.0	7.5	6.0	1.4
Queue Delay	0.0	0.0	0.0	0.0	0.0	0.0	0.0	0.0	0.0
Total Delay	42.0	18.5	53.9	14.5	11.9	6.0	7.5	6.0	1.4
Queue Length 50th (m)	6.6	7.6	14.2	4.9	18.6	20.6	6.2	18.1	0.0
Queue Length 95th (m)	14.3	21.9	25.8	20.9	45.0	35.4	16.4	31.2	5.5
Internal Link Dist (m)		152.4		468.8		784.9		1711.9	
Turn Bay Length (m)	70.0		105.0		75.0		100.0		100.0
Base Capacity (vph)	311	583	333	633	495	2184	464	2214	1034
Starvation Cap Reductn	0	0	0	0	0	0	0	0	0
Spillback Cap Reductn	0	0	0	0	0	0	0	0	0
Storage Cap Reductn	0	0	0	0	0	0	0	0	0
Reduced v/c Ratio	0.11	0.24	0.22	0.30	0.50	0.31	0.23	0.26	0.13

Intersection Summary





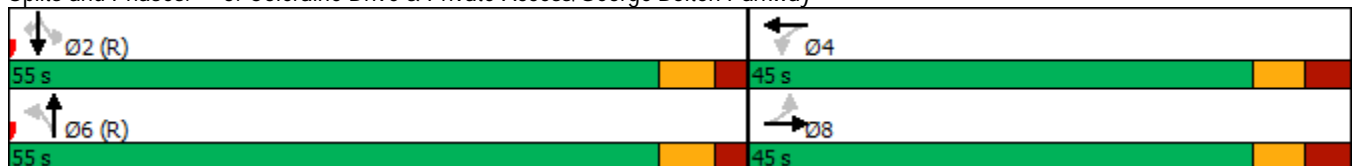

















Cycle Length: 100
 Actuated Cycle Length: 100
 Offset: 0 (0%), Referenced to phase 2:SBTL and 6:NBTL, Start of Green
 Natural Cycle: 70
 Control Type: Actuated-Coordinated

Splits and Phases: 5: Coleraine Drive & Private Access/George Bolton Parkway



HCM Signalized Intersection Capacity Analysis
 5: Coleraine Drive & Private Access/George Bolton Parkway

Future Total (2043) - Optimized
 AM Peak Hour

												
Movement	EBL	EBT	EBR	WBL	WBT	WBR	NBL	NBT	NBR	SBL	SBT	SBR
Lane Configurations												
Traffic Volume (vph)	30	35	86	63	23	141	213	485	96	93	499	113
Future Volume (vph)	30	35	86	63	23	141	213	485	96	93	499	113
Ideal Flow (vphpl)	1900	1900	1900	1900	1900	1900	1900	1900	1900	1900	1900	1900
Lane Width	3.0	3.5	3.0	3.0	3.5	3.0	3.0	3.5	3.0	3.0	3.5	3.0
Total Lost time (s)	7.5	7.5		7.5	7.5		6.7	6.7		6.7	6.7	6.7
Lane Util. Factor	1.00	1.00		1.00	1.00		1.00	0.95		1.00	0.95	1.00
Frt	1.00	0.89		1.00	0.87		1.00	0.98		1.00	1.00	0.85
Flt Protected	0.95	1.00		0.95	1.00		0.95	1.00		0.95	1.00	1.00
Satd. Flow (prot)	1491	1387		1267	1417		1532	3076		1589	3131	1409
Flt Permitted	0.53	1.00		0.67	1.00		0.43	1.00		0.39	1.00	1.00
Satd. Flow (perm)	829	1387		889	1417		699	3076		655	3131	1409
Peak-hour factor, PHF	0.86	0.86	0.86	0.86	0.86	0.86	0.86	0.86	0.86	0.86	0.86	0.86
Adj. Flow (vph)	35	41	100	73	27	164	248	564	112	108	580	131
RTOR Reduction (vph)	0	85	0	0	139	0	0	9	0	0	0	38
Lane Group Flow (vph)	35	56	0	73	52	0	248	667	0	108	580	93
Heavy Vehicles (%)	13%	26%	19%	33%	43%	11%	10%	12%	19%	6%	14%	7%
Turn Type	Perm	NA		Perm	NA		Perm	NA		Perm	NA	Perm
Protected Phases		8			4			6			2	
Permitted Phases	8			4			6			2		2
Actuated Green, G (s)	15.1	15.1		15.1	15.1		70.7	70.7		70.7	70.7	70.7
Effective Green, g (s)	15.1	15.1		15.1	15.1		70.7	70.7		70.7	70.7	70.7
Actuated g/C Ratio	0.15	0.15		0.15	0.15		0.71	0.71		0.71	0.71	0.71
Clearance Time (s)	7.5	7.5		7.5	7.5		6.7	6.7		6.7	6.7	6.7
Vehicle Extension (s)	3.0	3.0		3.0	3.0		3.0	3.0		3.0	3.0	3.0
Lane Grp Cap (vph)	125	209		134	213		494	2174		463	2213	996
v/s Ratio Prot		0.04			0.04			0.22			0.19	
v/s Ratio Perm	0.04			c0.08			c0.35			0.16		0.07
v/c Ratio	0.28	0.27		0.54	0.24		0.50	0.31		0.23	0.26	0.09
Uniform Delay, d1	37.6	37.6		39.3	37.4		6.7	5.5		5.1	5.3	4.6
Progression Factor	1.00	1.00		1.00	1.00		1.00	1.00		1.00	1.00	1.00
Incremental Delay, d2	1.2	0.7		4.5	0.6		3.6	0.4		1.2	0.3	0.2
Delay (s)	38.9	38.3		43.7	38.0		10.3	5.8		6.3	5.6	4.8
Level of Service	D	D		D	D		B	A		A	A	A
Approach Delay (s)		38.4			39.6			7.0			5.5	
Approach LOS		D			D			A			A	

Intersection Summary		
HCM 2000 Control Delay	12.9	HCM 2000 Level of Service B
HCM 2000 Volume to Capacity ratio	0.51	
Actuated Cycle Length (s)	100.0	Sum of lost time (s) 14.2
Intersection Capacity Utilization	67.3%	ICU Level of Service C
Analysis Period (min)	15	

c Critical Lane Group

Queues
6: Highway 50 & George Bolton Parkway/Private Access

Future Total (2043) - Optimized
AM Peak Hour



Lane Group	EBL	EBT	WBT	NBL	NBT	SBL	SBT	SBR
Lane Configurations								
Traffic Volume (vph)	93	0	0	178	1030	3	1144	138
Future Volume (vph)	93	0	0	178	1030	3	1144	138
Lane Group Flow (vph)	97	124	1	185	1073	3	1192	144
Turn Type	Perm	NA	NA	pm+pt	NA	Perm	NA	Perm
Protected Phases		8	4	1	6		2	
Permitted Phases	8			6		2		2
Detector Phase	8	8	4	1	6	2	2	2
Switch Phase								
Minimum Initial (s)	8.0	8.0	8.0	5.0	12.0	12.0	12.0	12.0
Minimum Split (s)	32.6	32.6	32.6	8.0	27.3	27.3	27.3	27.3
Total Split (s)	35.0	35.0	35.0	10.0	85.0	75.0	75.0	75.0
Total Split (%)	29.2%	29.2%	29.2%	8.3%	70.8%	62.5%	62.5%	62.5%
Yellow Time (s)	4.0	4.0	4.0	3.0	4.0	4.0	4.0	4.0
All-Red Time (s)	2.6	2.6	2.6	0.0	2.3	2.3	2.3	2.3
Lost Time Adjust (s)	0.0	0.0	0.0	0.0	0.0	0.0	0.0	0.0
Total Lost Time (s)	6.6	6.6	6.6	3.0	6.3	6.3	6.3	6.3
Lead/Lag				Lead		Lag	Lag	Lag
Lead-Lag Optimize?				Yes		Yes	Yes	Yes
Recall Mode	None	None	None	None	C-Max	C-Max	C-Max	C-Max
v/c Ratio	0.65	0.43	0.00	0.59	0.41	0.01	0.55	0.15
Control Delay	68.8	7.2	0.0	12.1	5.7	10.3	13.7	2.4
Queue Delay	0.0	0.0	0.0	0.0	0.0	0.0	0.0	0.0
Total Delay	68.8	7.2	0.0	12.1	5.7	10.3	13.7	2.4
Queue Length 50th (m)	23.2	0.0	0.0	8.8	39.9	0.3	78.1	0.6
Queue Length 95th (m)	39.7	8.5	0.0	21.6	64.4	1.8	121.4	9.7
Internal Link Dist (m)		846.5	43.0		1045.6		1307.8	
Turn Bay Length (m)	85.0			40.0		135.0		60.0
Base Capacity (vph)	283	405	480	315	2634	308	2153	991
Starvation Cap Reductn	0	0	0	0	0	0	0	0
Spillback Cap Reductn	0	0	0	0	0	0	0	0
Storage Cap Reductn	0	0	0	0	0	0	0	0
Reduced v/c Ratio	0.34	0.31	0.00	0.59	0.41	0.01	0.55	0.15

Intersection Summary





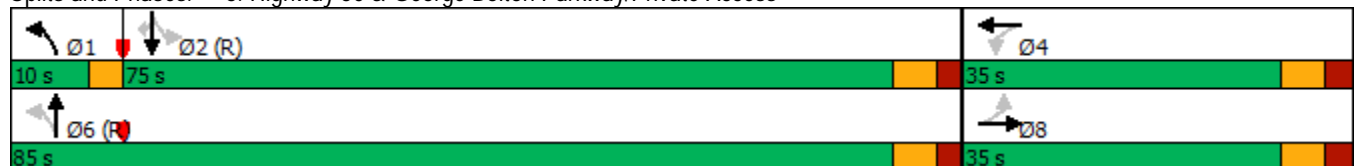















Cycle Length: 120
 Actuated Cycle Length: 120
 Offset: 0 (0%), Referenced to phase 2:SBTL and 6:NBTL, Start of Green
 Natural Cycle: 80
 Control Type: Actuated-Coordinated

Splits and Phases: 6: Highway 50 & George Bolton Parkway/Private Access



HCM Signalized Intersection Capacity Analysis
 6: Highway 50 & George Bolton Parkway/Private Access

Future Total (2043) - Optimized
 AM Peak Hour

												
Movement	EBL	EBT	EBR	WBL	WBT	WBR	NBL	NBT	NBR	SBL	SBT	SBR
Lane Configurations												
Traffic Volume (vph)	93	0	119	0	0	1	178	1030	0	3	1144	138
Future Volume (vph)	93	0	119	0	0	1	178	1030	0	3	1144	138
Ideal Flow (vphpl)	1900	1900	1900	1900	1900	1900	1900	1900	1900	1900	1900	1900
Lane Width	3.0	3.5	3.0	3.0	3.5	3.0	3.0	3.5	3.0	3.0	3.5	3.0
Total Lost time (s)	6.6	6.6			6.6		3.0	6.3		6.3	6.3	6.3
Lane Util. Factor	1.00	1.00			1.00		1.00	0.95		1.00	0.95	1.00
Frt	1.00	0.85			0.86		1.00	1.00		1.00	1.00	0.85
Flt Protected	0.95	1.00			1.00		0.95	1.00		0.95	1.00	1.00
Satd. Flow (prot)	1504	1192			1625		1404	3433		1685	3305	1449
Flt Permitted	0.76	1.00			1.00		0.18	1.00		0.27	1.00	1.00
Satd. Flow (perm)	1199	1192			1625		268	3433		473	3305	1449
Peak-hour factor, PHF	0.96	0.96	0.96	0.96	0.96	0.96	0.96	0.96	0.96	0.96	0.96	0.96
Adj. Flow (vph)	97	0	124	0	0	1	185	1073	0	3	1192	144
RTOR Reduction (vph)	0	109	0	0	1	0	0	0	0	0	0	48
Lane Group Flow (vph)	97	16	0	0	0	0	185	1073	0	3	1192	96
Heavy Vehicles (%)	12%	0%	34%	0%	0%	0%	20%	4%	0%	0%	8%	4%
Turn Type	Perm	NA			NA		pm+pt	NA		Perm	NA	Perm
Protected Phases		8			4		1	6			2	
Permitted Phases	8			4			6			2		2
Actuated Green, G (s)	15.0	15.0			15.0		92.1	92.1		78.2	78.2	78.2
Effective Green, g (s)	15.0	15.0			15.0		92.1	92.1		78.2	78.2	78.2
Actuated g/C Ratio	0.12	0.12			0.12		0.77	0.77		0.65	0.65	0.65
Clearance Time (s)	6.6	6.6			6.6		3.0	6.3		6.3	6.3	6.3
Vehicle Extension (s)	3.0	3.0			3.0		3.0	3.0		3.0	3.0	3.0
Lane Grp Cap (vph)	149	149			203		308	2634		308	2153	944
v/s Ratio Prot		0.01			0.00		c0.05	0.31			0.36	
v/s Ratio Perm	c0.08						c0.41			0.01		0.07
v/c Ratio	0.65	0.10			0.00		0.60	0.41		0.01	0.55	0.10
Uniform Delay, d1	50.0	46.5			45.9		7.0	4.7		7.3	11.4	7.8
Progression Factor	1.00	1.00			1.00		1.00	1.00		1.00	1.00	1.00
Incremental Delay, d2	9.8	0.3			0.0		3.3	0.5		0.1	1.0	0.2
Delay (s)	59.8	46.9			45.9		10.2	5.2		7.4	12.4	8.0
Level of Service	E	D			D		B	A		A	B	A
Approach Delay (s)		52.5			45.9			5.9			11.9	
Approach LOS		D			D			A			B	
Intersection Summary												
HCM 2000 Control Delay			12.4				HCM 2000 Level of Service				B	
HCM 2000 Volume to Capacity ratio			0.62									
Actuated Cycle Length (s)			120.0				Sum of lost time (s)			15.9		
Intersection Capacity Utilization			67.4%				ICU Level of Service			C		
Analysis Period (min)			15									

c Critical Lane Group

Queues
7: Arterial A2 & Mayfield Road

Future Total (2043) - Optimized
AM Peak Hour

	→	↘	↙	←	↖	↗
Lane Group	EBT	EBR	WBL	WBT	NBL	NBR
Lane Configurations	↑↑↑	↑	↘	↑↑↑	↘↘↘	↘
Traffic Volume (vph)	1310	841	226	885	84	149
Future Volume (vph)	1310	841	226	885	84	149
Lane Group Flow (vph)	1365	876	235	922	166	77
Turn Type	NA	Perm	Perm	NA	Prot	Perm
Protected Phases	2			6	4	
Permitted Phases		2	6			4
Detector Phase	2	2	6	6	4	4
Switch Phase						
Minimum Initial (s)	12.0	12.0	12.0	12.0	8.0	8.0
Minimum Split (s)	30.3	30.3	30.3	30.3	30.0	30.0
Total Split (s)	80.0	80.0	80.0	80.0	40.0	40.0
Total Split (%)	66.7%	66.7%	66.7%	66.7%	33.3%	33.3%
Yellow Time (s)	4.6	4.6	4.6	4.6	4.2	4.2
All-Red Time (s)	2.7	2.7	2.7	2.7	2.8	2.8
Lost Time Adjust (s)	0.0	0.0	0.0	0.0	0.0	0.0
Total Lost Time (s)	7.3	7.3	7.3	7.3	7.0	7.0
Lead/Lag						
Lead-Lag Optimize?						
Recall Mode	C-Max	C-Max	C-Max	C-Max	None	None
v/c Ratio	0.37	0.64	0.93	0.26	0.54	0.47
Control Delay	0.8	7.6	57.0	3.5	42.0	30.5
Queue Delay	0.0	0.0	0.0	0.0	0.0	0.0
Total Delay	0.8	7.6	57.0	3.5	42.0	30.5
Queue Length 50th (m)	2.2	49.8	36.7	17.2	14.0	6.2
Queue Length 95th (m)	4.5	79.8	#49.0	25.2	24.8	22.9
Internal Link Dist (m)	123.0			619.0	876.4	
Turn Bay Length (m)		60.0	100.0			
Base Capacity (vph)	3705	1377	252	3606	857	404
Starvation Cap Reductn	0	0	0	0	0	0
Spillback Cap Reductn	0	0	0	0	0	0
Storage Cap Reductn	0	0	0	0	0	0
Reduced v/c Ratio	0.37	0.64	0.93	0.26	0.19	0.19

Intersection Summary







Cycle Length: 120
 Actuated Cycle Length: 120
 Offset: 61 (51%), Referenced to phase 2:EBT and 6:WBTL, Start of Green
 Natural Cycle: 150
 Control Type: Actuated-Coordinated
 # 95th percentile volume exceeds capacity, queue may be longer.
 Queue shown is maximum after two cycles.

Splits and Phases: 7: Arterial A2 & Mayfield Road















HCM Signalized Intersection Capacity Analysis
7: Arterial A2 & Mayfield Road

Future Total (2043) - Optimized
AM Peak Hour

						
Movement	EBT	EBR	WBL	WBT	NBL	NBR
Lane Configurations	↑↑↑	↑	↓	↑↑↑	↓↓↓	↓
Traffic Volume (vph)	1310	841	226	885	84	149
Future Volume (vph)	1310	841	226	885	84	149
Ideal Flow (vphpl)	1900	1900	1900	1900	1900	1900
Lane Width	3.5	3.0	3.0	3.5	3.0	3.0
Total Lost time (s)	7.3	7.3	7.3	7.3	7.0	7.0
Lane Util. Factor	0.91	1.00	1.00	0.91	0.97	0.91
Frt	1.00	0.85	1.00	1.00	0.93	0.85
Flt Protected	1.00	1.00	0.95	1.00	0.97	1.00
Satd. Flow (prot)	4663	1507	1652	4539	2978	1332
Flt Permitted	1.00	1.00	0.18	1.00	0.97	1.00
Satd. Flow (perm)	4663	1507	318	4539	2978	1332
Peak-hour factor, PHF	0.96	0.96	0.96	0.96	0.96	0.96
Adj. Flow (vph)	1365	876	235	922	88	155
RTOR Reduction (vph)	0	180	0	0	48	48
Lane Group Flow (vph)	1365	696	235	922	118	29
Heavy Vehicles (%)	10%	0%	2%	13%	6%	3%
Turn Type	NA	Perm	Perm	NA	Prot	Perm
Protected Phases	2			6	4	
Permitted Phases		2	6			4
Actuated Green, G (s)	95.4	95.4	95.4	95.4	10.3	10.3
Effective Green, g (s)	95.4	95.4	95.4	95.4	10.3	10.3
Actuated g/C Ratio	0.80	0.80	0.80	0.80	0.09	0.09
Clearance Time (s)	7.3	7.3	7.3	7.3	7.0	7.0
Vehicle Extension (s)	3.0	3.0	3.0	3.0	3.0	3.0
Lane Grp Cap (vph)	3707	1198	252	3608	255	114
v/s Ratio Prot	0.29			0.20	c0.04	
v/s Ratio Perm		0.46	c0.74			0.02
v/c Ratio	0.37	0.58	0.93	0.26	0.46	0.25
Uniform Delay, d1	3.6	4.7	9.7	3.2	52.2	51.2
Progression Factor	0.17	21.22	1.00	1.00	1.00	1.00
Incremental Delay, d2	0.2	1.3	41.6	0.2	1.3	1.2
Delay (s)	0.8	100.8	51.4	3.3	53.5	52.4
Level of Service	A	F	D	A	D	D
Approach Delay (s)	39.9			13.1	53.2	
Approach LOS	D			B	D	
Intersection Summary						
HCM 2000 Control Delay			32.3		HCM 2000 Level of Service	C
HCM 2000 Volume to Capacity ratio			0.88			
Actuated Cycle Length (s)			120.0		Sum of lost time (s)	14.3
Intersection Capacity Utilization			76.8%		ICU Level of Service	D
Analysis Period (min)			15			
c Critical Lane Group						

Queues
 9: Humber Station Road & Subject Lands Site Access #1

Future Total (2043) - Optimized
 AM Peak Hour

						
Lane Group	WBL	WBR	NBT	NBR	SBL	SBT
Lane Configurations						
Traffic Volume (vph)	106	61	271	324	181	400
Future Volume (vph)	106	61	271	324	181	400
Lane Group Flow (vph)	106	61	271	324	181	400
Turn Type	Prot	Perm	NA	Perm	Perm	NA
Protected Phases	8		2			6
Permitted Phases		8		2	6	
Detector Phase	8	8	2	2	6	6
Switch Phase						
Minimum Initial (s)	12.0	12.0	12.0	12.0	12.0	12.0
Minimum Split (s)	25.5	25.5	24.7	24.7	24.7	24.7
Total Split (s)	45.0	45.0	75.0	75.0	75.0	75.0
Total Split (%)	37.5%	37.5%	62.5%	62.5%	62.5%	62.5%
Yellow Time (s)	4.0	4.0	4.2	4.2	4.2	4.2
All-Red Time (s)	3.5	3.5	2.5	2.5	2.5	2.5
Lost Time Adjust (s)	0.0	0.0	0.0	0.0	0.0	0.0
Total Lost Time (s)	7.5	7.5	6.7	6.7	6.7	6.7
Lead/Lag						
Lead-Lag Optimize?						
Recall Mode	None	None	C-Max	C-Max	C-Max	C-Max
v/c Ratio	0.59	0.28	0.20	0.28	0.24	0.29
Control Delay	62.3	14.4	3.0	0.8	2.7	2.5
Queue Delay	0.0	0.0	0.0	0.0	0.0	0.0
Total Delay	62.3	14.4	3.0	0.8	2.7	2.5
Queue Length 50th (m)	25.4	0.0	6.0	0.0	4.7	10.7
Queue Length 95th (m)	42.6	12.4	m13.6	0.3	m8.2	16.3
Internal Link Dist (m)	321.1		1542.4			454.2
Turn Bay Length (m)	100.0			30.0	100.0	
Base Capacity (vph)	453	447	1341	1145	744	1380
Starvation Cap Reductn	0	0	0	0	0	0
Spillback Cap Reductn	0	0	0	0	0	0
Storage Cap Reductn	0	0	0	0	0	0
Reduced v/c Ratio	0.23	0.14	0.20	0.28	0.24	0.29

Intersection Summary





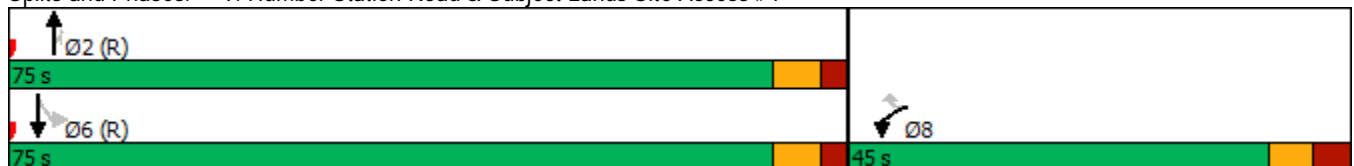







Cycle Length: 120
 Actuated Cycle Length: 120
 Offset: 116 (97%), Referenced to phase 2:NBT and 6:SBTL, Start of Green
 Natural Cycle: 55
 Control Type: Actuated-Coordinated
 m Volume for 95th percentile queue is metered by upstream signal.

Splits and Phases: 9: Humber Station Road & Subject Lands Site Access #1



HCM Signalized Intersection Capacity Analysis
 9: Humber Station Road & Subject Lands Site Access #1

Future Total (2043) - Optimized
 AM Peak Hour

						
Movement	WBL	WBR	NBT	NBR	SBL	SBT
Lane Configurations						
Traffic Volume (vph)	106	61	271	324	181	400
Future Volume (vph)	106	61	271	324	181	400
Ideal Flow (vphpl)	1900	1900	1900	1900	1900	1900
Lane Width	3.0	3.0	3.5	3.0	3.0	3.5
Total Lost time (s)	7.5	7.5	6.7	6.7	6.7	6.7
Lane Util. Factor	1.00	1.00	1.00	1.00	1.00	1.00
Frt	1.00	0.85	1.00	0.85	1.00	1.00
Flt Protected	0.95	1.00	1.00	1.00	0.95	1.00
Satd. Flow (prot)	1452	1299	1773	1409	1574	1824
Flt Permitted	0.95	1.00	1.00	1.00	0.59	1.00
Satd. Flow (perm)	1452	1299	1773	1409	982	1824
Peak-hour factor, PHF	1.00	1.00	1.00	1.00	1.00	1.00
Adj. Flow (vph)	106	61	271	324	181	400
RTOR Reduction (vph)	0	53	0	79	0	0
Lane Group Flow (vph)	106	8	271	245	181	400
Heavy Vehicles (%)	16%	16%	6%	7%	7%	3%
Turn Type	Prot	Perm	NA	Perm	Perm	NA
Protected Phases	8		2			6
Permitted Phases		8		2	6	
Actuated Green, G (s)	15.0	15.0	90.8	90.8	90.8	90.8
Effective Green, g (s)	15.0	15.0	90.8	90.8	90.8	90.8
Actuated g/C Ratio	0.12	0.12	0.76	0.76	0.76	0.76
Clearance Time (s)	7.5	7.5	6.7	6.7	6.7	6.7
Vehicle Extension (s)	3.0	3.0	3.0	3.0	3.0	3.0
Lane Grp Cap (vph)	181	162	1341	1066	743	1380
v/s Ratio Prot	c0.07		0.15			c0.22
v/s Ratio Perm		0.01		0.17	0.18	
v/c Ratio	0.59	0.05	0.20	0.23	0.24	0.29
Uniform Delay, d1	49.6	46.2	4.2	4.3	4.4	4.6
Progression Factor	1.00	1.00	0.60	0.50	0.40	0.41
Incremental Delay, d2	4.8	0.1	0.3	0.4	0.7	0.5
Delay (s)	54.3	46.3	2.8	2.6	2.5	2.3
Level of Service	D	D	A	A	A	A
Approach Delay (s)	51.4		2.7			2.4
Approach LOS	D		A			A

Intersection Summary

HCM 2000 Control Delay	8.6	HCM 2000 Level of Service	A
HCM 2000 Volume to Capacity ratio	0.33		
Actuated Cycle Length (s)	120.0	Sum of lost time (s)	14.2
Intersection Capacity Utilization	51.7%	ICU Level of Service	A
Analysis Period (min)	15		

c Critical Lane Group

Queues
24: Mayfield Road & Triangle Lands

Future Total (2043) - Optimized
AM Peak Hour



Lane Group	EBL	EBT	WBT	SBL	SBR
Lane Configurations	↗	↑↑↑	↑↑↑	↖	↗
Traffic Volume (vph)	160	1299	1029	33	72
Future Volume (vph)	160	1299	1029	33	72
Lane Group Flow (vph)	160	1299	1137	33	72
Turn Type	Perm	NA	NA	Prot	Perm
Protected Phases		2	6	4	
Permitted Phases	2				4
Detector Phase	2	2	6	4	4
Switch Phase					
Minimum Initial (s)	12.0	12.0	5.0	12.0	12.0
Minimum Split (s)	25.0	25.0	25.0	25.0	25.0
Total Split (s)	162.0	162.0	162.0	28.0	28.0
Total Split (%)	85.3%	85.3%	85.3%	14.7%	14.7%
Yellow Time (s)	4.6	4.6	4.2	4.6	4.6
All-Red Time (s)	2.4	2.4	2.8	2.4	2.4
Lost Time Adjust (s)	0.0	0.0	0.0	0.0	0.0
Total Lost Time (s)	7.0	7.0	7.0	7.0	7.0
Lead/Lag					
Lead-Lag Optimize?					
Recall Mode	C-Max	C-Max	Max	None	None
v/c Ratio	0.48	0.30	0.26	0.34	0.47
Control Delay	8.3	2.6	2.4	94.9	25.6
Queue Delay	0.0	0.0	0.0	0.0	0.0
Total Delay	8.3	2.6	2.4	94.9	25.6
Queue Length 50th (m)	12.1	28.4	23.0	12.9	0.0
Queue Length 95th (m)	25.6	33.9	27.8	26.6	18.9
Internal Link Dist (m)		619.0	290.4	250.9	
Turn Bay Length (m)	30.0			30.0	
Base Capacity (vph)	336	4375	4294	166	211
Starvation Cap Reductn	0	0	0	0	0
Spillback Cap Reductn	0	0	0	0	0
Storage Cap Reductn	0	0	0	0	0
Reduced v/c Ratio	0.48	0.30	0.26	0.20	0.34

Intersection Summary

Cycle Length: 190
 Actuated Cycle Length: 190
 Offset: 0 (0%), Referenced to phase 2:EBTL, Start of Green
 Natural Cycle: 70
 Control Type: Actuated-Coordinated

Splits and Phases: 24: Mayfield Road & Triangle Lands



HCM Signalized Intersection Capacity Analysis
 24: Mayfield Road & Triangle Lands

Future Total (2043) - Optimized
 AM Peak Hour



Movement	EBL	EBT	WBT	WBR	SBL	SBR
Lane Configurations	↖	↑↑↑	↑↑↑		↖	↗
Traffic Volume (vph)	160	1299	1029	108	33	72
Future Volume (vph)	160	1299	1029	108	33	72
Ideal Flow (vphpl)	1900	1900	1900	1900	1900	1900
Lane Width	3.0	3.5	3.5	3.0	3.0	3.0
Total Lost time (s)	7.0	7.0	7.0		7.0	7.0
Lane Util. Factor	1.00	0.91	0.91		1.00	1.00
Frt	1.00	1.00	0.99		1.00	0.85
Flt Protected	0.95	1.00	1.00		0.95	1.00
Satd. Flow (prot)	1574	5079	4978		1504	1334
Flt Permitted	0.24	1.00	1.00		0.95	1.00
Satd. Flow (perm)	392	5079	4978		1504	1334
Peak-hour factor, PHF	1.00	1.00	1.00	1.00	1.00	1.00
Adj. Flow (vph)	160	1299	1029	108	33	72
RTOR Reduction (vph)	0	0	5	0	0	67
Lane Group Flow (vph)	160	1299	1132	0	33	5
Heavy Vehicles (%)	7%	1%	1%	7%	12%	13%
Turn Type	Perm	NA	NA		Prot	Perm
Protected Phases		2	6		4	
Permitted Phases	2					4
Actuated Green, G (s)	163.7	163.7	163.7		12.3	12.3
Effective Green, g (s)	163.7	163.7	163.7		12.3	12.3
Actuated g/C Ratio	0.86	0.86	0.86		0.06	0.06
Clearance Time (s)	7.0	7.0	7.0		7.0	7.0
Vehicle Extension (s)	3.0	3.0	3.0		3.0	3.0
Lane Grp Cap (vph)	337	4375	4288		97	86
v/s Ratio Prot		0.26	0.23		c0.02	
v/s Ratio Perm	c0.41					0.00
v/c Ratio	0.47	0.30	0.26		0.34	0.05
Uniform Delay, d1	3.1	2.4	2.4		85.0	83.4
Progression Factor	1.00	1.00	1.00		1.00	1.00
Incremental Delay, d2	4.7	0.2	0.2		2.1	0.3
Delay (s)	7.8	2.6	2.5		87.1	83.7
Level of Service	A	A	A		F	F
Approach Delay (s)		3.2	2.5		84.7	
Approach LOS		A	A		F	













Intersection Summary

HCM 2000 Control Delay	6.1	HCM 2000 Level of Service	A
HCM 2000 Volume to Capacity ratio	0.46		
Actuated Cycle Length (s)	190.0	Sum of lost time (s)	14.0
Intersection Capacity Utilization	59.8%	ICU Level of Service	B
Analysis Period (min)	15		

c Critical Lane Group

HCM Unsignalized Intersection Capacity Analysis
 26: Humber Station Road & Subject Lands Site Access #3

Future Total (2043) - Optimized
 AM Peak Hour

						
Movement	WBL	WBR	NBT	NBR	SBL	SBT
Lane Configurations						
Traffic Volume (veh/h)	38	24	225	100	57	544
Future Volume (Veh/h)	38	24	225	100	57	544
Sign Control	Stop		Free		Free	
Grade	0%		0%		0%	
Peak Hour Factor	1.00	1.00	1.00	1.00	1.00	1.00
Hourly flow rate (vph)	38	24	225	100	57	544
Pedestrians						
Lane Width (m)						
Walking Speed (m/s)						
Percent Blockage						
Right turn flare (veh)						
Median type	None			None		
Median storage veh						
Upstream signal (m)						
pX, platoon unblocked						
vC, conflicting volume	883	225			325	
vC1, stage 1 conf vol						
vC2, stage 2 conf vol						
vCu, unblocked vol	883	225			325	
tC, single (s)	6.5	6.3			4.2	
tC, 2 stage (s)						
tF (s)	3.6	3.4			2.3	
p0 queue free %	87	97			95	
cM capacity (veh/h)	288	788			1207	
Direction, Lane #	WB 1	WB 2	NB 1	NB 2	SB 1	SB 2
Volume Total	38	24	225	100	57	544
Volume Left	38	0	0	0	57	0
Volume Right	0	24	0	100	0	0
cSH	288	788	1700	1700	1207	1700
Volume to Capacity	0.13	0.03	0.13	0.06	0.05	0.32
Queue Length 95th (m)	3.6	0.8	0.0	0.0	1.2	0.0
Control Delay (s)	19.4	9.7	0.0	0.0	8.1	0.0
Lane LOS	C	A			A	
Approach Delay (s)	15.6		0.0	0.8		
Approach LOS	C					
Intersection Summary						
Average Delay			1.5			
Intersection Capacity Utilization			38.6%	ICU Level of Service		A
Analysis Period (min)			15			

Queues
 27: Subject Lands Site Access #4 & Healey Road

Future Total (2043) - Optimized
 AM Peak Hour



Lane Group	EBT	WBL	WBT	NBL	NBR
Lane Configurations	↻	↻	↻	↻	↻
Traffic Volume (vph)	1096	67	635	32	27
Future Volume (vph)	1096	67	635	32	27
Lane Group Flow (vph)	1180	67	635	32	27
Turn Type	NA	Perm	NA	Prot	Perm
Protected Phases	4		8	2	
Permitted Phases		8			2
Detector Phase	4	8	8	2	2
Switch Phase					
Minimum Initial (s)	8.0	8.0	8.0	8.0	8.0
Minimum Split (s)	24.8	24.8	24.8	24.7	24.7
Total Split (s)	95.0	95.0	95.0	25.0	25.0
Total Split (%)	79.2%	79.2%	79.2%	20.8%	20.8%
Yellow Time (s)	4.0	4.0	4.0	4.6	4.6
All-Red Time (s)	2.8	2.8	2.8	2.1	2.1
Lost Time Adjust (s)	0.0	0.0	0.0	0.0	0.0
Total Lost Time (s)	6.8	6.8	6.8	6.7	6.7
Lead/Lag					
Lead-Lag Optimize?					
Recall Mode	C-Max	C-Max	C-Max	None	None
v/c Ratio	0.76	0.28	0.40	0.29	0.22
Control Delay	6.1	5.1	2.9	59.2	22.0
Queue Delay	0.0	0.0	0.0	0.0	0.0
Total Delay	6.1	5.1	2.9	59.2	22.0
Queue Length 50th (m)	6.5	1.0	9.4	7.7	0.0
Queue Length 95th (m)	m32.1	m7.7	62.2	18.1	9.4
Internal Link Dist (m)	505.1		823.7	346.9	
Turn Bay Length (m)		30.0		30.0	
Base Capacity (vph)	1559	239	1580	227	229
Starvation Cap Reductn	0	0	0	0	0
Spillback Cap Reductn	0	0	0	0	0
Storage Cap Reductn	0	0	0	0	0
Reduced v/c Ratio	0.76	0.28	0.40	0.14	0.12

Intersection Summary

Cycle Length: 120
 Actuated Cycle Length: 120
 Offset: 0 (0%), Referenced to phase 4:EBT and 8:WBTL, Start of Green
 Natural Cycle: 100
 Control Type: Actuated-Coordinated
 m Volume for 95th percentile queue is metered by upstream signal.

Splits and Phases: 27: Subject Lands Site Access #4 & Healey Road

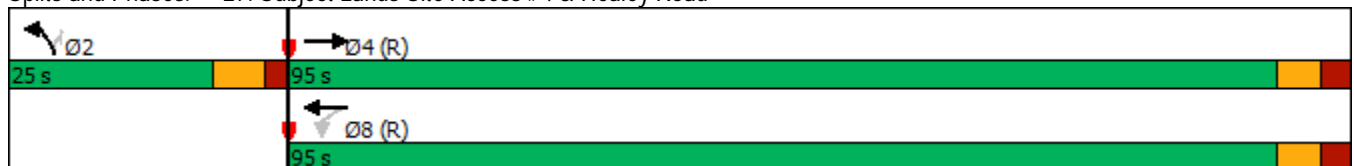

HCM Signalized Intersection Capacity Analysis
 27: Subject Lands Site Access #4 & Healey Road

Future Total (2043) - Optimized
 AM Peak Hour



Movement	EBT	EBR	WBL	WBT	NBL	NBR
Lane Configurations	↩		↩	↩	↩	↩
Traffic Volume (vph)	1096	84	67	635	32	27
Future Volume (vph)	1096	84	67	635	32	27
Ideal Flow (vphpl)	1900	1900	1900	1900	1900	1900
Lane Width	3.5	3.0	3.0	3.5	3.0	3.0
Total Lost time (s)	6.8		6.8	6.8	6.7	6.7
Lane Util. Factor	1.00		1.00	1.00	1.00	1.00
Frt	0.99		1.00	1.00	1.00	0.85
Flt Protected	1.00		0.95	1.00	0.95	1.00
Satd. Flow (prot)	1835		1574	1860	1491	1358
Flt Permitted	1.00		0.17	1.00	0.95	1.00
Satd. Flow (perm)	1835		282	1860	1491	1358
Peak-hour factor, PHF	1.00	1.00	1.00	1.00	1.00	1.00
Adj. Flow (vph)	1096	84	67	635	32	27
RTOR Reduction (vph)	2	0	0	0	0	25
Lane Group Flow (vph)	1178	0	67	635	32	2
Heavy Vehicles (%)	1%	7%	7%	1%	13%	11%
Turn Type	NA		Perm	NA	Prot	Perm
Protected Phases	4			8	2	
Permitted Phases			8			2
Actuated Green, G (s)	99.2		99.2	99.2	7.3	7.3
Effective Green, g (s)	99.2		99.2	99.2	7.3	7.3
Actuated g/C Ratio	0.83		0.83	0.83	0.06	0.06
Clearance Time (s)	6.8		6.8	6.8	6.7	6.7
Vehicle Extension (s)	3.0		3.0	3.0	3.0	3.0
Lane Grp Cap (vph)	1516		233	1537	90	82
v/s Ratio Prot	c0.64			0.34	c0.02	
v/s Ratio Perm			0.24			0.00
v/c Ratio	0.78		0.29	0.41	0.36	0.02
Uniform Delay, d1	5.0		2.4	2.7	54.1	53.0
Progression Factor	0.77		0.77	0.75	1.00	1.00
Incremental Delay, d2	1.6		2.8	0.7	2.4	0.1
Delay (s)	5.5		4.6	2.8	56.5	53.1
Level of Service	A		A	A	E	D
Approach Delay (s)	5.5			3.0	54.9	
Approach LOS	A			A	D	













Intersection Summary

HCM 2000 Control Delay	6.1	HCM 2000 Level of Service	A
HCM 2000 Volume to Capacity ratio	0.75		
Actuated Cycle Length (s)	120.0	Sum of lost time (s)	13.5
Intersection Capacity Utilization	80.7%	ICU Level of Service	D
Analysis Period (min)	15		

c Critical Lane Group

HCM Unsignalized Intersection Capacity Analysis
 28: Humber Station Road & Subject Lands Site Access #2

Future Total (2043) - Optimized
 AM Peak Hour

						
Movement	WBL	WBR	NBT	NBR	SBL	SBT
Lane Configurations						
Traffic Volume (veh/h)	3	2	323	9	4	578
Future Volume (Veh/h)	3	2	323	9	4	578
Sign Control	Stop		Free		Free	
Grade	0%		0%		0%	
Peak Hour Factor	1.00	1.00	1.00	1.00	1.00	1.00
Hourly flow rate (vph)	3	2	323	9	4	578
Pedestrians						
Lane Width (m)						
Walking Speed (m/s)						
Percent Blockage						
Right turn flare (veh)						
Median type			None		None	
Median storage veh						
Upstream signal (m)						
pX, platoon unblocked						
vC, conflicting volume	909	323			332	
vC1, stage 1 conf vol						
vC2, stage 2 conf vol						
vCu, unblocked vol	909	323			332	
tC, single (s)	6.7	6.2			4.1	
tC, 2 stage (s)						
tF (s)	3.8	3.3			2.2	
p0 queue free %	99	100			100	
cM capacity (veh/h)	269	723			1239	
Direction, Lane #	WB 1	WB 2	NB 1	NB 2	SB 1	SB 2
Volume Total	3	2	323	9	4	578
Volume Left	3	0	0	0	4	0
Volume Right	0	2	0	9	0	0
cSH	269	723	1700	1700	1239	1700
Volume to Capacity	0.01	0.00	0.19	0.01	0.00	0.34
Queue Length 95th (m)	0.3	0.1	0.0	0.0	0.1	0.0
Control Delay (s)	18.6	10.0	0.0	0.0	7.9	0.0
Lane LOS	C	A			A	
Approach Delay (s)	15.1	0.0		0.1		
Approach LOS	C					
Intersection Summary						
Average Delay			0.1			
Intersection Capacity Utilization			40.4%	ICU Level of Service		A
Analysis Period (min)			15			

HCM Unsignalized Intersection Capacity Analysis
 29: Mayfield Road & Subject Lands Site Access #5

Future Total (2043) - Optimized
 AM Peak Hour



Movement	EBL	EBT	WBT	WBR	SBL	SBR				
Lane Configurations	↶	↑↑↑	↑↑↑↶		↶	↷				
Traffic Volume (veh/h)	22	2145	954	15	6	9				
Future Volume (Veh/h)	22	2145	954	15	6	9				
Sign Control		Free	Free		Stop					
Grade		0%	0%		0%					
Peak Hour Factor	1.00	1.00	1.00	1.00	1.00	1.00				
Hourly flow rate (vph)	22	2145	954	15	6	9				
Pedestrians										
Lane Width (m)										
Walking Speed (m/s)										
Percent Blockage										
Right turn flare (veh)										
Median type		TWLT	TWLT							
Median storage (veh)		2	2							
Upstream signal (m)		265	147							
pX, platoon unblocked	0.96				0.66	0.96				
vC, conflicting volume	969				1720	326				
vC1, stage 1 conf vol					962					
vC2, stage 2 conf vol					759					
vCu, unblocked vol	827				0	157				
tC, single (s)	4.1				6.8	6.9				
tC, 2 stage (s)					5.8					
tF (s)	2.2				3.5	3.3				
p0 queue free %	97				99	99				
cM capacity (veh/h)	782				658	833				
Direction, Lane #	EB 1	EB 2	EB 3	EB 4	WB 1	WB 2	WB 3	SB 1	SB 2	
Volume Total	22	715	715	715	382	382	206	6	9	
Volume Left	22	0	0	0	0	0	0	6	0	
Volume Right	0	0	0	0	0	0	15	0	9	
cSH	782	1700	1700	1700	1700	1700	1700	658	833	
Volume to Capacity	0.03	0.42	0.42	0.42	0.22	0.22	0.12	0.01	0.01	
Queue Length 95th (m)	0.7	0.0	0.0	0.0	0.0	0.0	0.0	0.2	0.3	
Control Delay (s)	9.7	0.0	0.0	0.0	0.0	0.0	0.0	10.5	9.4	
Lane LOS	A							B	A	
Approach Delay (s)	0.1				0.0			9.8		
Approach LOS								A		
Intersection Summary										
Average Delay			0.1							
Intersection Capacity Utilization			51.4%	ICU Level of Service					A	
Analysis Period (min)			15							

Queues
1: Coleraine Drive & Healey Road

Future Total (2043) -Optimized
PM Peak Hour



Lane Group	EBL	EBT	WBL	WBT	NBL	NBT	SBL	SBT
Lane Configurations	↖	↗	↖	↗	↖	↕	↖	↕
Traffic Volume (vph)	251	277	81	571	420	551	47	217
Future Volume (vph)	251	277	81	571	420	551	47	217
Lane Group Flow (vph)	276	533	89	720	462	689	52	368
Turn Type	pm+pt	NA	Perm	NA	pm+pt	NA	Perm	NA
Protected Phases	3	8		4	1	6		2
Permitted Phases	8		4		6		2	
Detector Phase	3	8	4	4	1	6	2	2
Switch Phase								
Minimum Initial (s)	5.0	8.0	8.0	8.0	5.0	8.0	8.0	8.0
Minimum Split (s)	9.5	32.8	32.8	32.8	9.5	36.7	36.7	36.7
Total Split (s)	20.0	64.0	44.0	44.0	19.0	56.0	37.0	37.0
Total Split (%)	16.7%	53.3%	36.7%	36.7%	15.8%	46.7%	30.8%	30.8%
Yellow Time (s)	3.0	4.0	4.0	4.0	3.0	4.6	4.6	4.6
All-Red Time (s)	0.0	2.8	2.8	2.8	0.0	2.1	2.1	2.1
Lost Time Adjust (s)	0.0	0.0	0.0	0.0	0.0	0.0	0.0	0.0
Total Lost Time (s)	3.0	6.8	6.8	6.8	3.0	6.7	6.7	6.7
Lead/Lag	Lead		Lag	Lag	Lead		Lag	Lag
Lead-Lag Optimize?	Yes		Yes	Yes	Yes		Yes	Yes
Recall Mode	None	None	None	None	None	C-Max	C-Max	C-Max
v/c Ratio	0.95	0.64	0.39	1.29	1.04	0.53	0.36	0.47
Control Delay	70.2	20.7	38.7	177.0	83.3	27.9	45.3	31.4
Queue Delay	0.0	0.0	0.0	0.0	0.0	0.0	0.0	0.0
Total Delay	70.2	20.7	38.7	177.0	83.3	27.9	45.3	31.4
Queue Length 50th (m)	47.2	93.7	17.3	-227.4	-92.9	65.3	10.6	31.4
Queue Length 95th (m)	#104.1	121.4	34.0	#304.0	#179.8	84.3	23.8	47.0
Internal Link Dist (m)		823.7		424.0		1711.9		1121.0
Turn Bay Length (m)	55.0		50.0		80.0		155.0	
Base Capacity (vph)	291	835	228	560	444	1288	146	784
Starvation Cap Reductn	0	0	0	0	0	0	0	0
Spillback Cap Reductn	0	0	0	0	0	0	0	0
Storage Cap Reductn	0	0	0	0	0	0	0	0
Reduced v/c Ratio	0.95	0.64	0.39	1.29	1.04	0.53	0.36	0.47

Intersection Summary





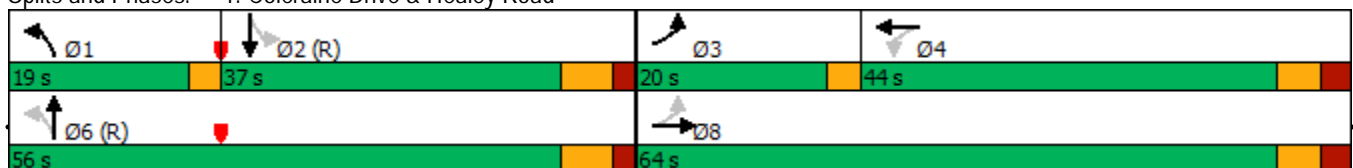

















Cycle Length: 120
 Actuated Cycle Length: 120
 Offset: 31 (26%), Referenced to phase 2:SBTL and 6:NBTL, Start of Green
 Natural Cycle: 130
 Control Type: Actuated-Coordinated
 ~ Volume exceeds capacity, queue is theoretically infinite.
 Queue shown is maximum after two cycles.
 # 95th percentile volume exceeds capacity, queue may be longer.
 Queue shown is maximum after two cycles.

Splits and Phases: 1: Coleraine Drive & Healey Road



HCM Signalized Intersection Capacity Analysis
 1: Coleraine Drive & Healey Road

Future Total (2043) -Optimized
 PM Peak Hour

												
Movement	EBL	EBT	EBR	WBL	WBT	WBR	NBL	NBT	NBR	SBL	SBT	SBR
Lane Configurations												
Traffic Volume (vph)	251	277	208	81	571	85	420	551	76	47	217	118
Future Volume (vph)	251	277	208	81	571	85	420	551	76	47	217	118
Ideal Flow (vphpl)	1900	1900	1900	1900	1900	1900	1900	1900	1900	1900	1900	1900
Lane Width	3.0	3.5	3.0	3.0	3.5	3.0	3.0	3.5	3.0	3.0	3.5	3.0
Total Lost time (s)	3.0	6.8		6.8	6.8		3.0	6.7		6.7	6.7	
Lane Util. Factor	1.00	1.00		1.00	1.00		1.00	0.95		1.00	0.95	
Flt	1.00	0.94		1.00	0.98		1.00	0.98		1.00	0.95	
Flt Protected	0.95	1.00		0.95	1.00		0.95	1.00		0.95	1.00	
Satd. Flow (prot)	1620	1704		1504	1790		1652	3116		1416	2865	
Flt Permitted	0.10	1.00		0.47	1.00		0.42	1.00		0.39	1.00	
Satd. Flow (perm)	169	1704		737	1790		728	3116		581	2865	
Peak-hour factor, PHF	0.91	0.91	0.91	0.91	0.91	0.91	0.91	0.91	0.91	0.91	0.91	0.91
Adj. Flow (vph)	276	304	229	89	627	93	462	605	84	52	238	130
RTOR Reduction (vph)	0	23	0	0	4	0	0	9	0	0	61	0
Lane Group Flow (vph)	276	510	0	89	716	0	462	680	0	52	307	0
Heavy Vehicles (%)	4%	1%	6%	12%	1%	16%	2%	12%	16%	19%	24%	7%
Turn Type	pm+pt	NA		Perm	NA		pm+pt	NA		Perm	NA	
Protected Phases	3	8			4		1	6			2	
Permitted Phases	8			4			6			2		
Actuated Green, G (s)	57.2	57.2		37.3	37.3		49.3	49.3		30.3	30.3	
Effective Green, g (s)	57.2	57.2		37.3	37.3		49.3	49.3		30.3	30.3	
Actuated g/C Ratio	0.48	0.48		0.31	0.31		0.41	0.41		0.25	0.25	
Clearance Time (s)	3.0	6.8		6.8	6.8		3.0	6.7		6.7	6.7	
Vehicle Extension (s)	3.0	3.0		3.0	3.0		3.0	3.0		3.0	3.0	
Lane Grp Cap (vph)	284	812		229	556		422	1280		146	723	
v/s Ratio Prot	c0.14	0.30			c0.40		c0.15	0.22			0.11	
v/s Ratio Perm	0.32			0.12			c0.30			0.09		
v/c Ratio	0.97	0.63		0.39	1.29		1.09	0.53		0.36	0.42	
Uniform Delay, d1	36.2	23.5		32.4	41.4		32.2	26.6		36.8	37.5	
Progression Factor	0.93	0.78		1.00	1.00		1.00	1.00		1.00	1.00	
Incremental Delay, d2	43.8	1.4		1.1	142.5		71.9	1.6		6.7	1.8	
Delay (s)	77.6	19.7		33.5	183.9		104.1	28.2		43.5	39.4	
Level of Service	E	B		C	F		F	C		D	D	
Approach Delay (s)		39.5			167.4			58.7			39.9	
Approach LOS		D			F			E			D	
Intersection Summary												
HCM 2000 Control Delay			78.9									E
HCM 2000 Volume to Capacity ratio			1.17									
Actuated Cycle Length (s)			120.0								19.5	
Intersection Capacity Utilization			100.1%									G
Analysis Period (min)			15									

c Critical Lane Group

Queues
2: Humber Station Road & Healey Road

Future Total (2043) -Optimized
PM Peak Hour

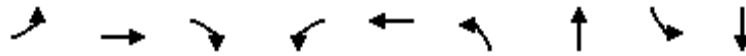

Lane Group	EBL	EBT	EBR	WBL	WBT	NBL	NBT	SBL	SBT
Lane Configurations	↖	↑	↗	↖	↗	↖	↗	↖	↗
Traffic Volume (vph)	21	478	79	128	1130	208	279	28	68
Future Volume (vph)	21	478	79	128	1130	208	279	28	68
Lane Group Flow (vph)	22	493	81	132	1188	214	496	29	76
Turn Type	Perm	NA	Perm	pm+pt	NA	Perm	NA	Perm	NA
Protected Phases		4		3	8		2		6
Permitted Phases	4		4	8		2		6	
Detector Phase	4	4	4	3	8	2	2	6	6
Switch Phase									
Minimum Initial (s)	8.0	8.0	8.0	5.0	8.0	8.0	8.0	8.0	8.0
Minimum Split (s)	24.8	24.8	24.8	8.0	24.8	24.7	24.7	24.7	24.7
Total Split (s)	62.0	62.0	62.0	10.0	72.0	48.0	48.0	48.0	48.0
Total Split (%)	51.7%	51.7%	51.7%	8.3%	60.0%	40.0%	40.0%	40.0%	40.0%
Yellow Time (s)	4.0	4.0	4.0	3.0	4.0	4.6	4.6	4.6	4.6
All-Red Time (s)	2.8	2.8	2.8	0.0	2.8	2.1	2.1	2.1	2.1
Lost Time Adjust (s)	0.0	0.0	0.0	0.0	0.0	0.0	0.0	0.0	0.0
Total Lost Time (s)	6.8	6.8	6.8	3.0	6.8	6.7	6.7	6.7	6.7
Lead/Lag	Lag	Lag	Lag	Lead					
Lead-Lag Optimize?	Yes	Yes	Yes	Yes					
Recall Mode	None	None	None	None	None	C-Max	C-Max	C-Max	C-Max
v/c Ratio	0.38	0.58	0.13	0.39	1.18	0.56	0.82	0.24	0.12
Control Delay	44.0	27.2	7.2	10.0	109.7	42.6	51.3	34.4	26.2
Queue Delay	0.0	0.0	0.0	0.0	0.0	0.0	0.0	0.0	0.0
Total Delay	44.0	27.2	7.2	10.0	109.7	42.6	51.3	34.4	26.2
Queue Length 50th (m)	3.5	87.7	2.7	8.5	~351.8	51.8	121.1	5.1	12.1
Queue Length 95th (m)	13.9	122.8	11.9	m13.8	#437.7	75.4	#164.3	14.0	23.8
Internal Link Dist (m)		465.5			505.1		463.9		452.2
Turn Bay Length (m)	30.0		30.0	60.0		30.0		30.0	
Base Capacity (vph)	58	855	630	342	1007	385	604	123	618
Starvation Cap Reductn	0	0	0	0	0	0	0	0	0
Spillback Cap Reductn	0	0	0	0	0	0	0	0	0
Storage Cap Reductn	0	0	0	0	0	0	0	0	0
Reduced v/c Ratio	0.38	0.58	0.13	0.39	1.18	0.56	0.82	0.24	0.12

Intersection Summary





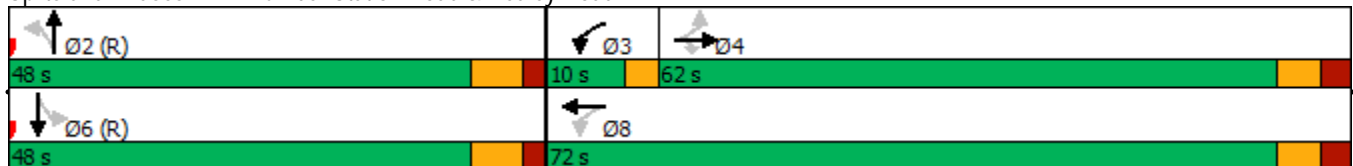

















Cycle Length: 120
 Actuated Cycle Length: 120
 Offset: 11 (9%), Referenced to phase 2:NBTL and 6:SBTL, Start of Green
 Natural Cycle: 130
 Control Type: Actuated-Coordinated
 ~ Volume exceeds capacity, queue is theoretically infinite.
 Queue shown is maximum after two cycles.
 # 95th percentile volume exceeds capacity, queue may be longer.
 Queue shown is maximum after two cycles.
 m Volume for 95th percentile queue is metered by upstream signal.

Splits and Phases: 2: Humber Station Road & Healey Road



HCM Signalized Intersection Capacity Analysis
2: Humber Station Road & Healey Road

Future Total (2043) -Optimized
PM Peak Hour

												
Movement	EBL	EBT	EBR	WBL	WBT	WBR	NBL	NBT	NBR	SBL	SBT	SBR
Lane Configurations												
Traffic Volume (vph)	21	478	79	128	1130	22	208	279	202	28	68	6
Future Volume (vph)	21	478	79	128	1130	22	208	279	202	28	68	6
Ideal Flow (vphpl)	1900	1900	1900	1900	1900	1900	1900	1900	1900	1900	1900	1900
Lane Width	3.0	3.5	3.0	3.0	3.5	3.0	3.0	3.5	3.0	3.0	3.5	3.0
Total Lost time (s)	6.8	6.8	6.8	3.0	6.8		6.7	6.7		6.7	6.7	
Lane Util. Factor	1.00	1.00	1.00	1.00	1.00		1.00	1.00		1.00	1.00	
Flt	1.00	1.00	0.85	1.00	1.00		1.00	0.94		1.00	0.99	
Flt Protected	0.95	1.00	1.00	0.95	1.00		0.95	1.00		0.95	1.00	
Satd. Flow (prot)	1685	1860	1299	1504	1853		1504	1694		1620	1791	
Flt Permitted	0.07	1.00	1.00	0.31	1.00		0.71	1.00		0.21	1.00	
Satd. Flow (perm)	129	1860	1299	494	1853		1120	1694		359	1791	
Peak-hour factor, PHF	0.97	0.97	0.97	0.97	0.97	0.97	0.97	0.97	0.97	0.97	0.97	0.97
Adj. Flow (vph)	22	493	81	132	1165	23	214	288	208	29	70	6
RTOR Reduction (vph)	0	0	33	0	0	0	0	22	0	0	3	0
Lane Group Flow (vph)	22	493	48	132	1188	0	214	474	0	29	73	0
Heavy Vehicles (%)	0%	1%	16%	12%	1%	5%	12%	1%	8%	4%	4%	0%
Turn Type	Perm	NA	Perm	pm+pt	NA		Perm	NA		Perm	NA	
Protected Phases		4		3	8			2			6	
Permitted Phases	4		4	8			2			6		
Actuated Green, G (s)	55.2	55.2	55.2	65.2	65.2		41.3	41.3		41.3	41.3	
Effective Green, g (s)	55.2	55.2	55.2	65.2	65.2		41.3	41.3		41.3	41.3	
Actuated g/C Ratio	0.46	0.46	0.46	0.54	0.54		0.34	0.34		0.34	0.34	
Clearance Time (s)	6.8	6.8	6.8	3.0	6.8		6.7	6.7		6.7	6.7	
Vehicle Extension (s)	3.0	3.0	3.0	3.0	3.0		3.0	3.0		3.0	3.0	
Lane Grp Cap (vph)	59	855	597	327	1006		385	583		123	616	
v/s Ratio Prot		0.27		0.02	c0.64			c0.28			0.04	
v/s Ratio Perm	0.17		0.04	0.20			0.19			0.08		
v/c Ratio	0.37	0.58	0.08	0.40	1.18		0.56	0.81		0.24	0.12	
Uniform Delay, d1	21.1	23.8	18.2	15.9	27.4		31.9	35.8		28.1	26.9	
Progression Factor	1.00	1.00	1.00	0.64	0.69		1.13	1.17		1.00	1.00	
Incremental Delay, d2	3.9	0.9	0.1	0.6	88.6		5.4	11.3		4.5	0.4	
Delay (s)	25.1	24.8	18.2	10.7	107.4		41.5	53.2		32.5	27.3	
Level of Service	C	C	B	B	F		D	D		C	C	
Approach Delay (s)		23.9			97.7			49.7			28.8	
Approach LOS		C			F			D			C	
Intersection Summary												
HCM 2000 Control Delay			66.5	HCM 2000 Level of Service				E				
HCM 2000 Volume to Capacity ratio			1.07									
Actuated Cycle Length (s)			120.0	Sum of lost time (s)				16.5				
Intersection Capacity Utilization			111.4%	ICU Level of Service				H				
Analysis Period (min)			15									

c Critical Lane Group

Queues

Future Total (2043) -Optimized

3: Clarkway Drive/Humber Station Road & Mayfield Road

PM Peak Hour

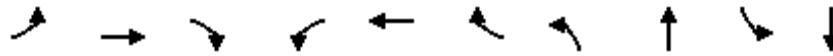

Lane Group	EBL	EBT	EBR	WBL	WBT	WBR	NBL	NBT	SBL	SBT
Lane Configurations	↘	↑↑↑	↗	↘	↑↑↑	↗	↘	↗	↘	↗
Traffic Volume (vph)	166	1282	19	100	1569	94	59	417	106	165
Future Volume (vph)	166	1282	19	100	1569	94	59	417	106	165
Lane Group Flow (vph)	171	1322	20	103	1618	97	61	537	109	437
Turn Type	pm+pt	NA	Perm	Perm	NA	Perm	Perm	NA	pm+pt	NA
Protected Phases	5	2			6			4	3	8
Permitted Phases	2		2	6		6	4		8	
Detector Phase	5	2	2	6	6	6	4	4	3	8
Switch Phase										
Minimum Initial (s)	5.0	12.0	12.0	12.0	12.0	12.0	8.0	8.0	5.0	8.0
Minimum Split (s)	9.5	27.3	27.3	27.3	27.3	27.3	26.0	26.0	9.5	26.0
Total Split (s)	15.0	62.0	62.0	47.0	47.0	47.0	48.0	48.0	10.0	58.0
Total Split (%)	12.5%	51.7%	51.7%	39.2%	39.2%	39.2%	40.0%	40.0%	8.3%	48.3%
Yellow Time (s)	3.0	4.6	4.6	4.6	4.6	4.6	4.2	4.2	3.0	4.2
All-Red Time (s)	0.0	2.7	2.7	2.7	2.7	2.7	2.8	2.8	0.0	2.8
Lost Time Adjust (s)	0.0	0.0	0.0	0.0	0.0	0.0	0.0	0.0	0.0	0.0
Total Lost Time (s)	3.0	7.3	7.3	7.3	7.3	7.3	7.0	7.0	3.0	7.0
Lead/Lag	Lead			Lag	Lag	Lag	Lag	Lag	Lead	
Lead-Lag Optimize?	Yes			Yes	Yes	Yes	Yes	Yes	Yes	
Recall Mode	None	C-Max	C-Max	C-Max	C-Max	C-Max	None	None	None	None
v/c Ratio	0.86	0.58	0.03	0.96	0.96	0.19	0.28	0.93	0.67	0.65
Control Delay	64.3	24.6	0.1	110.9	45.4	3.9	33.2	62.5	47.4	21.5
Queue Delay	0.0	0.0	0.0	0.0	0.0	0.0	0.0	0.0	0.0	0.0
Total Delay	64.3	24.6	0.1	110.9	45.4	3.9	33.2	62.5	47.4	21.5
Queue Length 50th (m)	28.3	88.2	0.0	-26.2	-153.6	2.4	10.9	122.5	12.1	40.3
Queue Length 95th (m)	#70.9	103.8	0.0	#64.3	#188.0	4.7	23.1	#187.2	#35.1	62.6
Internal Link Dist (m)		1635.6			240.8			1187.5		1542.4
Turn Bay Length (m)	150.0		105.0	150.0		115.0			105.0	
Base Capacity (vph)	200	2276	678	107	1683	523	233	610	163	705
Starvation Cap Reductn	0	0	0	0	0	0	0	0	0	0
Spillback Cap Reductn	0	0	0	0	0	0	0	0	0	0
Storage Cap Reductn	0	0	0	0	0	0	0	0	0	0
Reduced v/c Ratio	0.85	0.58	0.03	0.96	0.96	0.19	0.26	0.88	0.67	0.62

Intersection Summary





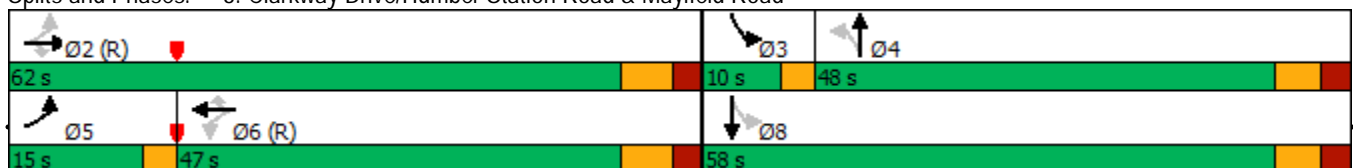

























Cycle Length: 120
 Actuated Cycle Length: 120
 Offset: 86 (72%), Referenced to phase 2:EBTL and 6:WBTL, Start of Green
 Natural Cycle: 90
 Control Type: Actuated-Coordinated
 ~ Volume exceeds capacity, queue is theoretically infinite.
 Queue shown is maximum after two cycles.
 # 95th percentile volume exceeds capacity, queue may be longer.
 Queue shown is maximum after two cycles.

Splits and Phases: 3: Clarkway Drive/Humber Station Road & Mayfield Road



HCM Signalized Intersection Capacity Analysis
 3: Clarkway Drive/Humber Station Road & Mayfield Road

Future Total (2043) -Optimized
 PM Peak Hour

												
Movement	EBL	EBT	EBR	WBL	WBT	WBR	NBL	NBT	NBR	SBL	SBT	SBR
Lane Configurations		  			  			 			 	
Traffic Volume (vph)	166	1282	19	100	1569	94	59	417	104	106	165	259
Future Volume (vph)	166	1282	19	100	1569	94	59	417	104	106	165	259
Ideal Flow (vphpl)	1900	1900	1900	1900	1900	1900	1900	1900	1900	1900	1900	1900
Lane Width	3.0	3.5	3.0	3.0	3.5	3.0	3.0	3.5	3.0	3.0	3.5	3.0
Total Lost time (s)	3.0	7.3	7.3	7.3	7.3	7.3	7.0	7.0		3.0	7.0	
Lane Util. Factor	1.00	0.91	1.00	1.00	0.91	1.00	1.00	1.00		1.00	1.00	
Fr _t	1.00	1.00	0.85	1.00	1.00	0.85	1.00	0.97		1.00	0.91	
Fl _t Protected	0.95	1.00	1.00	0.95	1.00	1.00	0.95	1.00		0.95	1.00	
Satd. Flow (prot)	1416	4794	1358	1518	4839	1322	1504	1766		1518	1551	
Fl _t Permitted	0.09	1.00	1.00	0.19	1.00	1.00	0.43	1.00		0.12	1.00	
Satd. Flow (perm)	133	4794	1358	308	4839	1322	684	1766		198	1551	
Peak-hour factor, PHF	0.97	0.97	0.97	0.97	0.97	0.97	0.97	0.97	0.97	0.97	0.97	0.97
Adj. Flow (vph)	171	1322	20	103	1618	97	61	430	107	109	170	267
RTOR Reduction (vph)	0	0	11	0	0	63	0	7	0	0	49	0
Lane Group Flow (vph)	171	1322	10	103	1618	34	61	530	0	109	388	0
Heavy Vehicles (%)	19%	7%	11%	11%	6%	14%	12%	3%	4%	11%	7%	12%
Turn Type	pm+pt	NA	Perm	Perm	NA	Perm	Perm	NA		pm+pt	NA	
Protected Phases	5	2			6			4		3	8	
Permitted Phases	2		2	6		6	4			8		
Actuated Green, G (s)	57.0	57.0	57.0	41.8	41.8	41.8	38.7	38.7		48.7	48.7	
Effective Green, g (s)	57.0	57.0	57.0	41.8	41.8	41.8	38.7	38.7		48.7	48.7	
Actuated g/C Ratio	0.48	0.48	0.48	0.35	0.35	0.35	0.32	0.32		0.41	0.41	
Clearance Time (s)	3.0	7.3	7.3	7.3	7.3	7.3	7.0	7.0		3.0	7.0	
Vehicle Extension (s)	3.0	3.0	3.0	3.0	3.0	3.0	3.0	3.0		3.0	3.0	
Lane Grp Cap (vph)	193	2277	645	107	1685	460	220	569		157	629	
v/s Ratio Prot	c0.09	0.28			0.33			c0.30		c0.04	0.25	
v/s Ratio Perm	0.33		0.01	c0.33		0.03	0.09			0.24		
v/c Ratio	0.89	0.58	0.01	0.96	0.96	0.07	0.28	0.93		0.69	0.62	
Uniform Delay, d ₁	31.6	22.8	16.7	38.3	38.3	26.1	30.2	39.4		27.4	28.3	
Progression Factor	1.00	1.00	1.00	0.77	0.79	0.57	1.00	1.00		1.37	0.74	
Incremental Delay, d ₂	34.9	1.1	0.0	74.6	13.7	0.3	0.7	22.1		12.0	1.7	
Delay (s)	66.5	23.9	16.7	104.1	44.0	15.1	30.9	61.4		49.5	22.8	
Level of Service	E	C	B	F	D	B	C	E		D	C	
Approach Delay (s)		28.6			45.9			58.3			28.1	
Approach LOS		C			D			E			C	
Intersection Summary												
HCM 2000 Control Delay			39.5									D
HCM 2000 Volume to Capacity ratio			0.92									
Actuated Cycle Length (s)			120.0							20.3		
Intersection Capacity Utilization			92.2%									F
Analysis Period (min)			15									

c Critical Lane Group

Queues

Future Total (2043) -Optimized

4: Coleraine Drive & Mayfield Road

PM Peak Hour

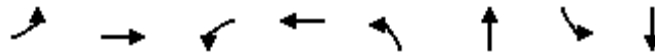

Lane Group	EBL	EBT	WBL	WBT	NBL	NBT	SBL	SBT
Lane Configurations	↘	↑↑↓	↘	↑↑	↘	↑↓	↘	↑↑
Traffic Volume (vph)	399	1071	13	904	26	413	135	201
Future Volume (vph)	399	1071	13	904	26	413	135	201
Lane Group Flow (vph)	420	1142	14	1091	27	457	142	641
Turn Type	pm+pt	NA	Perm	NA	Perm	NA	pm+pt	NA
Protected Phases	5	2		6		4	3	8
Permitted Phases	2		6		4		8	
Detector Phase	5	2	6	6	4	4	3	8
Switch Phase								
Minimum Initial (s)	5.0	12.0	12.0	12.0	12.0	12.0	5.0	12.0
Minimum Split (s)	8.0	37.0	37.0	37.0	37.0	37.0	8.0	37.0
Total Split (s)	28.0	80.0	52.0	52.0	36.0	36.0	14.0	50.0
Total Split (%)	21.5%	61.5%	40.0%	40.0%	27.7%	27.7%	10.8%	38.5%
Yellow Time (s)	3.0	4.6	4.6	4.6	4.2	4.2	3.0	4.2
All-Red Time (s)	0.0	2.4	2.4	2.4	2.8	2.8	0.0	2.8
Lost Time Adjust (s)	0.0	0.0	0.0	0.0	0.0	0.0	0.0	0.0
Total Lost Time (s)	3.0	7.0	7.0	7.0	7.0	7.0	3.0	7.0
Lead/Lag	Lead		Lag	Lag	Lag	Lag	Lead	
Lead-Lag Optimize?	Yes		Yes	Yes	Yes	Yes	Yes	
Recall Mode	None	C-Max	C-Max	C-Max	None	None	None	None
v/c Ratio	0.98	0.37	0.10	0.96	0.23	0.76	0.71	0.58
Control Delay	77.5	13.1	31.5	59.2	50.4	59.7	54.5	15.8
Queue Delay	0.0	0.0	0.0	0.0	0.0	0.0	0.0	0.0
Total Delay	77.5	13.1	31.5	59.2	50.4	59.7	54.5	15.8
Queue Length 50th (m)	97.7	52.8	2.6	149.1	6.4	62.0	29.5	27.2
Queue Length 95th (m)	#184.6	69.4	8.1	#196.0	15.5	77.7	#47.1	44.4
Internal Link Dist (m)		290.4		195.1		791.2		576.8
Turn Bay Length (m)	100.0		85.0		105.0		145.0	
Base Capacity (vph)	427	3074	134	1141	154	793	202	1255
Starvation Cap Reductn	0	0	0	0	0	0	0	0
Spillback Cap Reductn	0	0	0	0	0	0	0	0
Storage Cap Reductn	0	0	0	0	0	0	0	0
Reduced v/c Ratio	0.98	0.37	0.10	0.96	0.18	0.58	0.70	0.51

Intersection Summary

Cycle Length: 130
 Actuated Cycle Length: 130
 Offset: 0 (0%), Referenced to phase 2:EBTL and 6:WBTL, Start of Green
 Natural Cycle: 120
 Control Type: Actuated-Coordinated
 # 95th percentile volume exceeds capacity, queue may be longer.
 Queue shown is maximum after two cycles.

Splits and Phases: 4: Coleraine Drive & Mayfield Road



HCM Signalized Intersection Capacity Analysis
4: Coleraine Drive & Mayfield Road

Future Total (2043) -Optimized
PM Peak Hour

Movement	EBL	EBT	EBR	WBL	WBT	WBR	NBL	NBT	NBR	SBL	SBT	SBR
Lane Configurations												
Traffic Volume (vph)	399	1071	14	13	904	132	26	413	21	135	201	408
Future Volume (vph)	399	1071	14	13	904	132	26	413	21	135	201	408
Ideal Flow (vphpl)	1900	1900	1900	1900	1900	1900	1900	1900	1900	1900	1900	1900
Lane Width	3.0	3.5	3.0	3.0	3.5	3.0	3.0	3.5	3.0	3.0	3.5	3.0
Total Lost time (s)	3.0	7.0		7.0	7.0		7.0	7.0		3.0	7.0	
Lane Util. Factor	1.00	0.91		1.00	0.95		1.00	0.95		1.00	0.95	
Fr't	1.00	1.00		1.00	0.98		1.00	0.99		1.00	0.90	
Fl't Protected	0.95	1.00		0.95	1.00		0.95	1.00		0.95	1.00	
Satd. Flow (prot)	1504	4972		1560	3271		1685	3544		1440	2973	
Fl't Permitted	0.08	1.00		0.24	1.00		0.39	1.00		0.24	1.00	
Satd. Flow (perm)	132	4972		388	3271		693	3544		364	2973	
Peak-hour factor, PHF	0.95	0.95	0.95	0.95	0.95	0.95	0.95	0.95	0.95	0.95	0.95	0.95
Adj. Flow (vph)	420	1127	15	14	952	139	27	435	22	142	212	429
RTOR Reduction (vph)	0	1	0	0	9	0	0	3	0	0	295	0
Lane Group Flow (vph)	420	1141	0	14	1082	0	27	454	0	142	346	0
Heavy Vehicles (%)	12%	3%	0%	8%	5%	21%	0%	0%	0%	17%	0%	12%
Turn Type	pm+pt	NA		Perm	NA		Perm	NA		pm+pt	NA	
Protected Phases	5	2			6			4		3	8	
Permitted Phases	2			6			4			8		
Actuated Green, G (s)	80.3	80.3		44.9	44.9		21.9	21.9		35.7	35.7	
Effective Green, g (s)	80.3	80.3		44.9	44.9		21.9	21.9		35.7	35.7	
Actuated g/C Ratio	0.62	0.62		0.35	0.35		0.17	0.17		0.27	0.27	
Clearance Time (s)	3.0	7.0		7.0	7.0		7.0	7.0		3.0	7.0	
Vehicle Extension (s)	3.0	3.0		3.0	3.0		3.0	3.0		3.0	3.0	
Lane Grp Cap (vph)	423	3071		134	1129		116	597		189	816	
v/s Ratio Prot	c0.25	0.23			0.33			0.13		c0.06	0.12	
v/s Ratio Perm	c0.36			0.04			0.04			c0.14		
v/c Ratio	0.99	0.37		0.10	0.96		0.23	0.76		0.75	0.42	
Uniform Delay, d1	40.3	12.3		28.9	41.6		46.8	51.5		38.7	38.7	
Progression Factor	1.00	1.00		1.00	1.00		1.00	1.00		1.00	1.00	
Incremental Delay, d2	41.7	0.3		1.6	18.5		1.0	5.5		15.4	0.4	
Delay (s)	82.0	12.7		30.5	60.1		47.8	57.1		54.1	39.1	
Level of Service	F	B		C	E		D	E		D	D	
Approach Delay (s)		31.3			59.7			56.6			41.8	
Approach LOS		C			E			E			D	
Intersection Summary												
HCM 2000 Control Delay			44.5								HCM 2000 Level of Service	D
HCM 2000 Volume to Capacity ratio			0.96									
Actuated Cycle Length (s)			130.0								Sum of lost time (s)	20.0
Intersection Capacity Utilization			100.8%								ICU Level of Service	G
Analysis Period (min)			15									
c	Critical Lane Group											

Queues

Future Total (2043) -Optimized

5: Coleraine Drive & Private Access/George Bolton Parkway

PM Peak Hour



Lane Group	EBL	EBT	WBL	WBT	NBL	NBT	SBL	SBT	SBR
Lane Configurations	↶	↷	↶	↷	↶	↷	↶	↷	↷
Traffic Volume (vph)	76	87	61	9	95	522	169	538	52
Future Volume (vph)	76	87	61	9	95	522	169	538	52
Lane Group Flow (vph)	92	363	73	198	114	713	204	648	63
Turn Type	Perm	NA	Perm	NA	Perm	NA	Perm	NA	Perm
Protected Phases		8		4		6		2	
Permitted Phases	8		4		6		2		2
Detector Phase	8	8	4	4	6	6	2	2	2
Switch Phase									
Minimum Initial (s)	8.0	8.0	12.0	12.0	12.0	12.0	12.0	12.0	12.0
Minimum Split (s)	32.5	32.5	32.5	32.5	34.2	34.2	33.7	33.7	33.7
Total Split (s)	45.0	45.0	45.0	45.0	55.0	55.0	55.0	55.0	55.0
Total Split (%)	45.0%	45.0%	45.0%	45.0%	55.0%	55.0%	55.0%	55.0%	55.0%
Yellow Time (s)	4.0	4.0	4.0	4.0	4.2	4.2	4.2	4.2	4.2
All-Red Time (s)	3.5	3.5	3.5	3.5	2.5	2.5	2.5	2.5	2.5
Lost Time Adjust (s)	0.0	0.0	0.0	0.0	0.0	0.0	0.0	0.0	0.0
Total Lost Time (s)	7.5	7.5	7.5	7.5	6.7	6.7	6.7	6.7	6.7
Lead/Lag									
Lead-Lag Optimize?									
Recall Mode	None	None	None	None	C-Max	C-Max	C-Max	C-Max	C-Max
v/c Ratio	0.46	0.82	0.88	0.42	0.31	0.36	0.53	0.32	0.08
Control Delay	38.9	36.6	106.0	7.6	13.4	10.1	19.1	10.0	3.1
Queue Delay	0.0	0.0	0.0	0.0	0.0	0.0	0.0	0.0	0.0
Total Delay	38.9	36.6	106.0	7.6	13.4	10.1	19.1	10.0	3.1
Queue Length 50th (m)	16.4	44.2	14.5	1.8	9.5	31.4	20.5	28.5	0.0
Queue Length 95th (m)	25.3	58.5	#28.7	13.5	24.4	51.5	49.9	47.0	5.2
Internal Link Dist (m)		152.4		468.8		784.9		1711.9	
Turn Bay Length (m)	70.0		105.0		75.0		100.0		100.0
Base Capacity (vph)	342	655	142	675	367	1968	384	2014	830
Starvation Cap Reductn	0	0	0	0	0	0	0	0	0
Spillback Cap Reductn	0	0	0	0	0	0	0	0	0
Storage Cap Reductn	0	0	0	0	0	0	0	0	0
Reduced v/c Ratio	0.27	0.55	0.51	0.29	0.31	0.36	0.53	0.32	0.08

Intersection Summary

Cycle Length: 100
 Actuated Cycle Length: 100
 Offset: 0 (0%), Referenced to phase 2:SBTL and 6:NBTL, Start of Green
 Natural Cycle: 70
 Control Type: Actuated-Coordinated
 # 95th percentile volume exceeds capacity, queue may be longer.
 Queue shown is maximum after two cycles.

Splits and Phases: 5: Coleraine Drive & Private Access/George Bolton Parkway

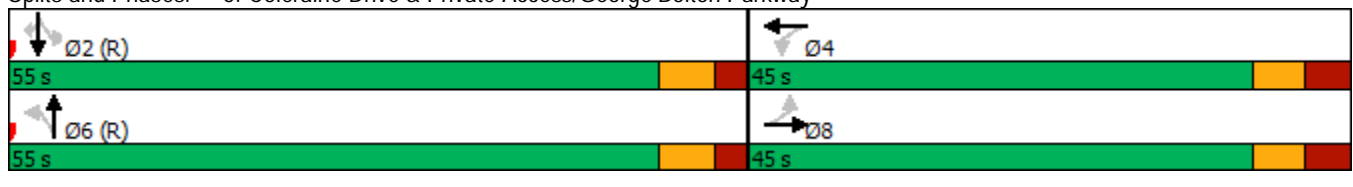























HCM Signalized Intersection Capacity Analysis

Future Total (2043) -Optimized

5: Coleraine Drive & Private Access/George Bolton Parkway

PM Peak Hour

												
Movement	EBL	EBT	EBR	WBL	WBT	WBR	NBL	NBT	NBR	SBL	SBT	SBR
Lane Configurations												
Traffic Volume (vph)	76	87	214	61	9	155	95	522	70	169	538	52
Future Volume (vph)	76	87	214	61	9	155	95	522	70	169	538	52
Ideal Flow (vphpl)	1900	1900	1900	1900	1900	1900	1900	1900	1900	1900	1900	1900
Lane Width	3.0	3.5	3.0	3.0	3.5	3.0	3.0	3.5	3.0	3.0	3.5	3.0
Total Lost time (s)	7.5	7.5		7.5	7.5		6.7	6.7		6.7	6.7	6.7
Lane Util. Factor	1.00	1.00		1.00	1.00		1.00	0.95		1.00	0.95	1.00
Fr _t	1.00	0.89		1.00	0.86		1.00	0.98		1.00	1.00	0.85
Fl _t Protected	0.95	1.00		0.95	1.00		0.95	1.00		0.95	1.00	1.00
Satd. Flow (prot)	1518	1510		1491	1491		1392	3076		1574	3159	1267
Fl _t Permitted	0.57	1.00		0.24	1.00		0.39	1.00		0.36	1.00	1.00
Satd. Flow (perm)	913	1510		381	1491		578	3076		603	3159	1267
Peak-hour factor, PHF	0.83	0.83	0.83	0.83	0.83	0.83	0.83	0.83	0.83	0.83	0.83	0.83
Adj. Flow (vph)	92	105	258	73	11	187	114	629	84	204	648	63
RTOR Reduction (vph)	0	111	0	0	146	0	0	7	0	0	0	23
Lane Group Flow (vph)	92	252	0	73	52	0	114	706	0	204	648	40
Heavy Vehicles (%)	11%	9%	12%	13%	11%	8%	21%	14%	14%	7%	13%	19%
Turn Type	Perm	NA		Perm	NA		Perm	NA		Perm	NA	Perm
Protected Phases		8			4			6			2	
Permitted Phases	8			4			6			2		2
Actuated Green, G (s)	22.0	22.0		22.0	22.0		63.8	63.8		63.8	63.8	63.8
Effective Green, g (s)	22.0	22.0		22.0	22.0		63.8	63.8		63.8	63.8	63.8
Actuated g/C Ratio	0.22	0.22		0.22	0.22		0.64	0.64		0.64	0.64	0.64
Clearance Time (s)	7.5	7.5		7.5	7.5		6.7	6.7		6.7	6.7	6.7
Vehicle Extension (s)	3.0	3.0		3.0	3.0		3.0	3.0		3.0	3.0	3.0
Lane Grp Cap (vph)	200	332		83	328		368	1962		384	2015	808
v/s Ratio Prot		0.17			0.03			0.23			0.21	
v/s Ratio Perm	0.10			c0.19			0.20			c0.34		0.03
v/c Ratio	0.46	0.76		0.88	0.16		0.31	0.36		0.53	0.32	0.05
Uniform Delay, d ₁	33.8	36.5		37.7	31.5		8.2	8.5		9.9	8.2	6.8
Progression Factor	1.00	1.00		1.00	1.00		1.00	1.00		1.00	1.00	1.00
Incremental Delay, d ₂	1.7	9.6		59.7	0.2		2.2	0.5		5.2	0.4	0.1
Delay (s)	35.5	46.1		97.4	31.8		10.3	9.0		15.1	8.7	6.9
Level of Service	D	D		F	C		B	A		B	A	A
Approach Delay (s)		44.0			49.4			9.2			10.0	
Approach LOS		D			D			A			A	
Intersection Summary												
HCM 2000 Control Delay			20.3				HCM 2000 Level of Service				C	
HCM 2000 Volume to Capacity ratio			0.62									
Actuated Cycle Length (s)			100.0				Sum of lost time (s)			14.2		
Intersection Capacity Utilization			78.1%				ICU Level of Service			D		
Analysis Period (min)			15									

c Critical Lane Group

Queues
6: Highway 50 & George Bolton Parkway/Private Access

Future Total (2043) -Optimized
PM Peak Hour



Lane Group	EBL	EBT	WBT	NBL	NBT	SBL	SBT	SBR
Lane Configurations								
Traffic Volume (vph)	253	0	0	157	1534	1	983	169
Future Volume (vph)	253	0	0	157	1534	1	983	169
Lane Group Flow (vph)	264	244	7	164	1598	1	1024	176
Turn Type	Perm	NA	NA	pm+pt	NA	Perm	NA	Perm
Protected Phases		8	4	1	6		2	
Permitted Phases	8			6		2		2
Detector Phase	8	8	4	1	6	2	2	2
Switch Phase								
Minimum Initial (s)	8.0	8.0	8.0	5.0	12.0	12.0	12.0	12.0
Minimum Split (s)	32.6	32.6	32.6	8.0	27.3	27.3	27.3	27.3
Total Split (s)	35.0	35.0	35.0	10.0	85.0	75.0	75.0	75.0
Total Split (%)	29.2%	29.2%	29.2%	8.3%	70.8%	62.5%	62.5%	62.5%
Yellow Time (s)	4.0	4.0	4.0	3.0	4.0	4.0	4.0	4.0
All-Red Time (s)	2.6	2.6	2.6	0.0	2.3	2.3	2.3	2.3
Lost Time Adjust (s)	0.0	0.0	0.0	0.0	0.0	0.0	0.0	0.0
Total Lost Time (s)	6.6	6.6	6.6	3.0	6.3	6.3	6.3	6.3
Lead/Lag				Lead		Lag	Lag	Lag
Lead-Lag Optimize?				Yes		Yes	Yes	Yes
Recall Mode	None	None	None	None	C-Max	C-Max	C-Max	C-Max
v/c Ratio	0.91	0.53	0.02	0.57	0.70	0.01	0.51	0.19
Control Delay	80.2	14.2	0.1	14.6	14.7	11.0	16.1	2.2
Queue Delay	0.0	0.0	0.0	0.0	0.0	0.0	0.0	0.0
Total Delay	80.2	14.2	0.1	14.6	14.7	11.0	16.1	2.2
Queue Length 50th (m)	63.1	10.1	0.0	13.2	123.4	0.1	77.0	0.0
Queue Length 95th (m)	#111.2	35.5	0.0	21.7	149.7	1.0	94.9	9.7
Internal Link Dist (m)		846.5	43.0		1045.6		1307.8	
Turn Bay Length (m)	85.0			40.0		135.0		60.0
Base Capacity (vph)	306	479	428	290	2296	119	2023	915
Starvation Cap Reductn	0	0	0	0	0	0	0	0
Spillback Cap Reductn	0	0	0	0	0	0	0	0
Storage Cap Reductn	0	0	0	0	0	0	0	0
Reduced v/c Ratio	0.86	0.51	0.02	0.57	0.70	0.01	0.51	0.19

Intersection Summary

Cycle Length: 120
 Actuated Cycle Length: 120
 Offset: 0 (0%), Referenced to phase 2:SBTL and 6:NBTL, Start of Green
 Natural Cycle: 80
 Control Type: Actuated-Coordinated
 # 95th percentile volume exceeds capacity, queue may be longer.
 Queue shown is maximum after two cycles.

Splits and Phases: 6: Highway 50 & George Bolton Parkway/Private Access

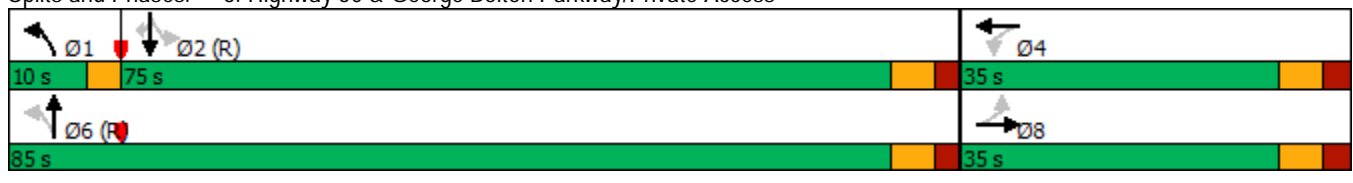

HCM Signalized Intersection Capacity Analysis
6: Highway 50 & George Bolton Parkway/Private Access

Future Total (2043) -Optimized
PM Peak Hour

Movement	EBL	EBT	EBR	WBL	WBT	WBR	NBL	NBT	NBR	SBL	SBT	SBR
Lane Configurations												
Traffic Volume (vph)	253	0	234	0	0	7	157	1534	0	1	983	169
Future Volume (vph)	253	0	234	0	0	7	157	1534	0	1	983	169
Ideal Flow (vphpl)	1900	1900	1900	1900	1900	1900	1900	1900	1900	1900	1900	1900
Lane Width	3.0	3.5	3.0	3.0	3.5	3.0	3.0	3.5	3.0	3.0	3.5	3.0
Total Lost time (s)	6.6	6.6			6.6		3.0	6.3		6.3	6.3	6.3
Lane Util. Factor	1.00	1.00			1.00		1.00	0.95		1.00	0.95	1.00
Frbp, ped/bikes	1.00	0.99			1.00		1.00	1.00		1.00	1.00	0.98
Flpb, ped/bikes	1.00	1.00			1.00		1.00	1.00		1.00	1.00	1.00
Frt	1.00	0.85			0.86		1.00	1.00		1.00	1.00	0.85
Flt Protected	0.95	1.00			1.00		0.95	1.00		0.95	1.00	1.00
Satd. Flow (prot)	1636	1405			1625		1440	3433		1685	3466	1444
Flt Permitted	0.75	1.00			1.00		0.21	1.00		0.12	1.00	1.00
Satd. Flow (perm)	1297	1405			1625		320	3433		206	3466	1444
Peak-hour factor, PHF	0.96	0.96	0.96	0.96	0.96	0.96	0.96	0.96	0.96	0.96	0.96	0.96
Adj. Flow (vph)	264	0	244	0	0	7	164	1598	0	1	1024	176
RTOR Reduction (vph)	0	150	0	0	5	0	0	0	0	0	0	73
Lane Group Flow (vph)	264	94	0	0	2	0	164	1598	0	1	1024	103
Confl. Peds. (#/hr)			2	2			1					1
Heavy Vehicles (%)	3%	0%	12%	0%	0%	0%	17%	4%	0%	0%	3%	2%
Turn Type	Perm	NA			NA		pm+pt	NA		Perm	NA	Perm
Protected Phases		8			4		1	6			2	
Permitted Phases	8			4			6			2		2
Actuated Green, G (s)	26.8	26.8			26.8		80.3	80.3		70.1	70.1	70.1
Effective Green, g (s)	26.8	26.8			26.8		80.3	80.3		70.1	70.1	70.1
Actuated g/C Ratio	0.22	0.22			0.22		0.67	0.67		0.58	0.58	0.58
Clearance Time (s)	6.6	6.6			6.6		3.0	6.3		6.3	6.3	6.3
Vehicle Extension (s)	3.0	3.0			3.0		3.0	3.0		3.0	3.0	3.0
Lane Grp Cap (vph)	289	313			362		281	2297		120	2024	843
v/s Ratio Prot		0.07			0.00		0.03	c0.47			0.30	
v/s Ratio Perm	c0.20						0.36			0.00		0.07
v/c Ratio	0.91	0.30			0.00		0.58	0.70		0.01	0.51	0.12
Uniform Delay, d1	45.5	38.8			36.2		9.6	12.3		10.4	14.7	11.2
Progression Factor	1.00	1.00			1.00		1.00	1.00		1.00	1.00	1.00
Incremental Delay, d2	31.2	0.5			0.0		3.1	1.8		0.1	0.9	0.3
Delay (s)	76.7	39.3			36.2		12.7	14.1		10.6	15.6	11.5
Level of Service	E	D			D		B	B		B	B	B
Approach Delay (s)		58.8			36.2			13.9			15.0	
Approach LOS		E			D			B			B	
Intersection Summary												
HCM 2000 Control Delay			20.9									C
HCM 2000 Volume to Capacity ratio			0.77									
Actuated Cycle Length (s)			120.0							15.9		
Intersection Capacity Utilization			89.2%									E
Analysis Period (min)			15									
c Critical Lane Group												

Queues
7: Arterial A2 & Mayfield Road

Future Total (2043) -Optimized
PM Peak Hour

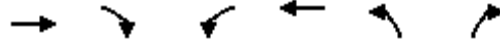

Lane Group	EBT	EBR	WBL	WBT	NBL	NBR
Lane Configurations	↑↑↑	↑	↵	↑↑↑	↵↵↵	↵
Traffic Volume (vph)	1197	297	251	1287	464	251
Future Volume (vph)	1197	297	251	1287	464	251
Lane Group Flow (vph)	1234	306	259	1327	509	228
Turn Type	NA	Perm	pm+pt	NA	Prot	Perm
Protected Phases	2		1	6	4	
Permitted Phases		2	6			4
Detector Phase	2	2	1	6	4	4
Switch Phase						
Minimum Initial (s)	12.0	12.0	5.0	12.0	8.0	8.0
Minimum Split (s)	30.3	30.3	9.5	30.3	30.0	30.0
Total Split (s)	55.0	55.0	10.0	65.0	55.0	55.0
Total Split (%)	45.8%	45.8%	8.3%	54.2%	45.8%	45.8%
Yellow Time (s)	4.6	4.6	3.0	4.6	4.2	4.2
All-Red Time (s)	2.7	2.7	0.0	2.7	2.8	2.8
Lost Time Adjust (s)	0.0	0.0	0.0	0.0	0.0	0.0
Total Lost Time (s)	7.3	7.3	3.0	7.3	7.0	7.0
Lead/Lag	Lag	Lag	Lead			
Lead-Lag Optimize?	Yes	Yes	Yes			
Recall Mode	C-Max	C-Max	None	C-Max	None	None
v/c Ratio	0.60	0.39	0.55	0.42	0.76	0.57
Control Delay	11.8	1.8	20.6	13.4	51.3	19.7
Queue Delay	0.0	0.0	0.0	0.0	0.0	0.0
Total Delay	11.8	1.8	20.6	13.4	51.3	19.7
Queue Length 50th (m)	19.1	0.2	32.2	45.8	61.0	17.3
Queue Length 95th (m)	93.1	m2.0	63.6	105.6	74.7	43.5
Internal Link Dist (m)	123.0			619.0	876.4	
Turn Bay Length (m)		60.0	100.0			
Base Capacity (vph)	2051	794	467	3163	1281	629
Starvation Cap Reductn	0	0	0	0	0	0
Spillback Cap Reductn	0	0	0	0	0	0
Storage Cap Reductn	0	0	0	0	0	0
Reduced v/c Ratio	0.60	0.39	0.55	0.42	0.40	0.36

Intersection Summary

Cycle Length: 120
 Actuated Cycle Length: 120
 Offset: 96 (80%), Referenced to phase 2:EBT and 6:WBTL, Start of Green
 Natural Cycle: 75
 Control Type: Actuated-Coordinated
 m Volume for 95th percentile queue is metered by upstream signal.



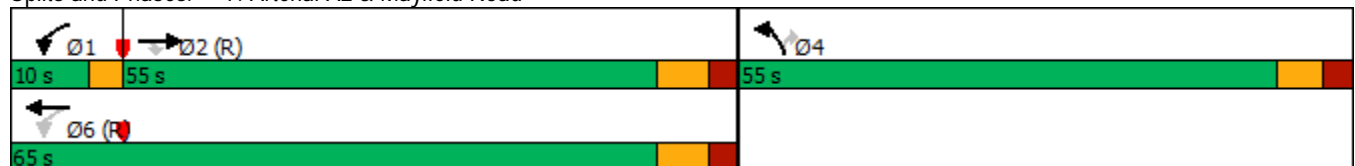



Splits and Phases: 7: Arterial A2 & Mayfield Road



HCM Signalized Intersection Capacity Analysis

7: Arterial A2 & Mayfield Road

Future Total (2043) -Optimized
PM Peak Hour

						
Movement	EBT	EBR	WBL	WBT	NBL	NBR
Lane Configurations	↑↑↑	↑	↑	↑↑↑	↑↑↑	↑
Traffic Volume (vph)	1197	297	251	1287	464	251
Future Volume (vph)	1197	297	251	1287	464	251
Ideal Flow (vphpl)	1900	1900	1900	1900	1900	1900
Lane Width	3.5	3.0	3.0	3.5	3.0	3.0
Total Lost time (s)	7.3	7.3	3.0	7.3	7.0	7.0
Lane Util. Factor	0.91	1.00	1.00	0.91	0.97	0.91
Frt	1.00	0.85	1.00	1.00	0.99	0.85
Flt Protected	1.00	1.00	0.95	1.00	0.96	1.00
Satd. Flow (prot)	4749	1463	1620	4706	3192	1345
Flt Permitted	1.00	1.00	0.14	1.00	0.96	1.00
Satd. Flow (perm)	4749	1463	243	4706	3192	1345
Peak-hour factor, PHF	0.97	0.97	0.97	0.97	0.97	0.97
Adj. Flow (vph)	1234	306	259	1327	478	259
RTOR Reduction (vph)	0	163	0	0	6	121
Lane Group Flow (vph)	1234	143	259	1327	503	107
Heavy Vehicles (%)	8%	3%	4%	9%	2%	2%
Turn Type	NA	Perm	pm+pt	NA	Prot	Perm
Protected Phases	2		1	6	4	
Permitted Phases		2	6			4
Actuated Green, G (s)	51.9	51.9	80.7	80.7	25.0	25.0
Effective Green, g (s)	51.9	51.9	80.7	80.7	25.0	25.0
Actuated g/C Ratio	0.43	0.43	0.67	0.67	0.21	0.21
Clearance Time (s)	7.3	7.3	3.0	7.3	7.0	7.0
Vehicle Extension (s)	3.0	3.0	3.0	3.0	3.0	3.0
Lane Grp Cap (vph)	2053	632	459	3164	665	280
v/s Ratio Prot	c0.26		c0.12	0.28	c0.16	
v/s Ratio Perm		0.10	0.26			0.08
v/c Ratio	0.60	0.23	0.56	0.42	0.76	0.38
Uniform Delay, d1	26.1	21.4	13.8	9.0	44.6	40.9
Progression Factor	0.40	0.19	1.22	1.36	1.00	1.00
Incremental Delay, d2	1.1	0.7	1.5	0.4	4.9	0.9
Delay (s)	11.6	4.8	18.4	12.6	49.6	41.7
Level of Service	B	A	B	B	D	D
Approach Delay (s)	10.3			13.5	47.1	
Approach LOS	B			B	D	

Intersection Summary

HCM 2000 Control Delay	18.6	HCM 2000 Level of Service	B
HCM 2000 Volume to Capacity ratio	0.63		
Actuated Cycle Length (s)	120.0	Sum of lost time (s)	17.3
Intersection Capacity Utilization	68.1%	ICU Level of Service	C
Analysis Period (min)	15		

c Critical Lane Group

Queues
 9: Humber Station Road & Subject Lands Site Access #1

Future Total (2043) -Optimized
 PM Peak Hour

Lane Group	WBL	WBR	NBT	NBR	SBL	SBT
Lane Configurations						
Traffic Volume (vph)	284	161	515	162	89	246
Future Volume (vph)	284	161	515	162	89	246
Lane Group Flow (vph)	284	161	515	162	89	246
Turn Type	Prot	Perm	NA	Perm	Perm	NA
Protected Phases	8		2			6
Permitted Phases		8		2	6	
Detector Phase	8	8	2	2	6	6
Switch Phase						
Minimum Initial (s)	12.0	12.0	12.0	12.0	12.0	12.0
Minimum Split (s)	25.5	25.5	24.7	24.7	24.7	24.7
Total Split (s)	59.0	59.0	61.0	61.0	61.0	61.0
Total Split (%)	49.2%	49.2%	50.8%	50.8%	50.8%	50.8%
Yellow Time (s)	4.0	4.0	4.2	4.2	4.2	4.2
All-Red Time (s)	3.5	3.5	2.5	2.5	2.5	2.5
Lost Time Adjust (s)	0.0	0.0	0.0	0.0	0.0	0.0
Total Lost Time (s)	7.5	7.5	6.7	6.7	6.7	6.7
Lead/Lag						
Lead-Lag Optimize?						
Recall Mode	None	None	C-Max	C-Max	C-Max	C-Max
v/c Ratio	0.79	0.36	0.45	0.19	0.23	0.22
Control Delay	57.6	7.0	15.4	7.2	12.5	10.7
Queue Delay	0.0	0.0	0.0	0.0	0.0	0.0
Total Delay	57.6	7.0	15.4	7.2	12.5	10.7
Queue Length 50th (m)	66.3	0.0	91.9	13.9	8.3	23.0
Queue Length 95th (m)	88.7	15.6	m135.3	m23.4	17.2	37.3
Internal Link Dist (m)	321.1		1542.4			454.2
Turn Bay Length (m)	100.0			30.0	100.0	
Base Capacity (vph)	645	669	1147	835	390	1106
Starvation Cap Reductn	0	0	0	0	0	0
Spillback Cap Reductn	0	0	0	0	0	0
Storage Cap Reductn	0	0	0	0	0	0
Reduced v/c Ratio	0.44	0.24	0.45	0.19	0.23	0.22

Intersection Summary





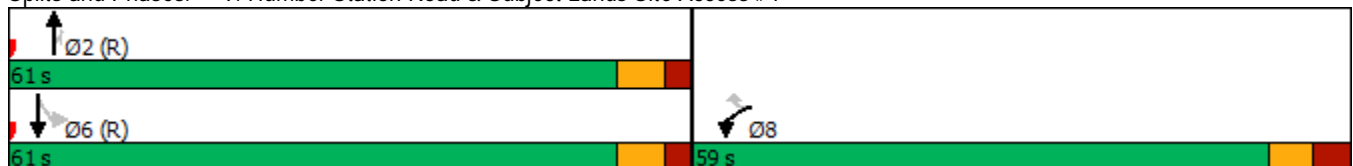







Cycle Length: 120
 Actuated Cycle Length: 120
 Offset: 21 (18%), Referenced to phase 2:NBT and 6:SBTL, Start of Green
 Natural Cycle: 60
 Control Type: Actuated-Coordinated
 m Volume for 95th percentile queue is metered by upstream signal.

Splits and Phases: 9: Humber Station Road & Subject Lands Site Access #1



HCM Signalized Intersection Capacity Analysis
 9: Humber Station Road & Subject Lands Site Access #1

Future Total (2043) -Optimized
 PM Peak Hour

						
Movement	WBL	WBR	NBT	NBR	SBL	SBT
Lane Configurations						
Traffic Volume (vph)	284	161	515	162	89	246
Future Volume (vph)	284	161	515	162	89	246
Ideal Flow (vphpl)	1900	1900	1900	1900	1900	1900
Lane Width	3.0	3.0	3.5	3.0	3.0	3.5
Total Lost time (s)	7.5	7.5	6.7	6.7	6.7	6.7
Lane Util. Factor	1.00	1.00	1.00	1.00	1.00	1.00
Frt	1.00	0.85	1.00	0.85	1.00	1.00
Flt Protected	0.95	1.00	1.00	1.00	0.95	1.00
Satd. Flow (prot)	1504	1346	1789	1256	1416	1724
Flt Permitted	0.95	1.00	1.00	1.00	0.41	1.00
Satd. Flow (perm)	1504	1346	1789	1256	609	1724
Peak-hour factor, PHF	1.00	1.00	1.00	1.00	1.00	1.00
Adj. Flow (vph)	284	161	515	162	89	246
RTOR Reduction (vph)	0	122	0	29	0	0
Lane Group Flow (vph)	284	39	515	133	89	246
Heavy Vehicles (%)	12%	12%	5%	20%	19%	9%
Turn Type	Prot	Perm	NA	Perm	Perm	NA
Protected Phases	8		2			6
Permitted Phases		8		2	6	
Actuated Green, G (s)	28.8	28.8	77.0	77.0	77.0	77.0
Effective Green, g (s)	28.8	28.8	77.0	77.0	77.0	77.0
Actuated g/C Ratio	0.24	0.24	0.64	0.64	0.64	0.64
Clearance Time (s)	7.5	7.5	6.7	6.7	6.7	6.7
Vehicle Extension (s)	3.0	3.0	3.0	3.0	3.0	3.0
Lane Grp Cap (vph)	360	323	1147	805	390	1106
v/s Ratio Prot	c0.19		c0.29			0.14
v/s Ratio Perm		0.03		0.11	0.15	
v/c Ratio	0.79	0.12	0.45	0.16	0.23	0.22
Uniform Delay, d1	42.8	35.7	10.8	8.6	9.0	9.0
Progression Factor	1.00	1.00	1.18	1.25	0.97	0.99
Incremental Delay, d2	10.9	0.2	0.8	0.3	1.3	0.5
Delay (s)	53.7	35.8	13.5	11.0	10.1	9.3
Level of Service	D	D	B	B	B	A
Approach Delay (s)	47.2		12.9			9.5
Approach LOS	D		B			A

Intersection Summary			
HCM 2000 Control Delay	22.6	HCM 2000 Level of Service	C
HCM 2000 Volume to Capacity ratio	0.54		
Actuated Cycle Length (s)	120.0	Sum of lost time (s)	14.2
Intersection Capacity Utilization	70.3%	ICU Level of Service	C
Analysis Period (min)	15		

c Critical Lane Group

Queues
24: Mayfield Road & Triangle Lands

Future Total (2043) -Optimized
PM Peak Hour

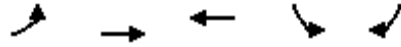

Lane Group	EBL	EBT	WBT	SBL	SBR
Lane Configurations	↖	↑↑↑	↑↑↑	↖	↗
Traffic Volume (vph)	85	1363	1345	75	167
Future Volume (vph)	85	1363	1345	75	167
Lane Group Flow (vph)	85	1363	1402	75	167
Turn Type	Perm	NA	NA	Prot	Perm
Protected Phases		2	6	4	
Permitted Phases	2				4
Detector Phase	2	2	6	4	4
Switch Phase					
Minimum Initial (s)	12.0	12.0	12.0	5.0	5.0
Minimum Split (s)	37.0	37.0	37.0	33.0	33.0
Total Split (s)	87.0	87.0	87.0	33.0	33.0
Total Split (%)	72.5%	72.5%	72.5%	27.5%	27.5%
Yellow Time (s)	4.6	4.6	4.6	3.0	3.0
All-Red Time (s)	2.4	2.4	2.4	0.0	0.0
Lost Time Adjust (s)	0.0	0.0	0.0	0.0	0.0
Total Lost Time (s)	7.0	7.0	7.0	3.0	3.0
Lead/Lag					
Lead-Lag Optimize?					
Recall Mode	C-Max	C-Max	C-Max	None	None
v/c Ratio	0.39	0.34	0.35	0.43	0.75
Control Delay	8.4	0.6	4.2	54.2	47.0
Queue Delay	0.0	0.0	0.0	0.0	0.0
Total Delay	8.4	0.6	4.2	54.2	47.0
Queue Length 50th (m)	0.5	2.5	28.8	17.5	22.5
Queue Length 95th (m)	m12.3	4.2	49.5	30.8	44.2
Internal Link Dist (m)		619.0	290.4	250.9	
Turn Bay Length (m)	30.0			30.0	
Base Capacity (vph)	216	4043	3963	366	386
Starvation Cap Reductn	0	0	0	0	0
Spillback Cap Reductn	0	0	0	0	0
Storage Cap Reductn	0	0	0	0	0
Reduced v/c Ratio	0.39	0.34	0.35	0.20	0.43

Intersection Summary

Cycle Length: 120
 Actuated Cycle Length: 120
 Offset: 0 (0%), Referenced to phase 2:EBTL and 6:WBT, Start of Green
 Natural Cycle: 80
 Control Type: Actuated-Coordinated
 m Volume for 95th percentile queue is metered by upstream signal.

Splits and Phases: 24: Mayfield Road & Triangle Lands



HCM Signalized Intersection Capacity Analysis
 24: Mayfield Road & Triangle Lands

Future Total (2043) -Optimized
 PM Peak Hour



Movement	EBL	EBT	WBT	WBR	SBL	SBR
Lane Configurations	↖	↑↑↑	↑↑↑		↘	↘
Traffic Volume (vph)	85	1363	1345	57	75	167
Future Volume (vph)	85	1363	1345	57	75	167
Ideal Flow (vphpl)	1900	1900	1900	1900	1900	1900
Lane Width	3.0	3.5	3.5	3.0	3.0	3.0
Total Lost time (s)	7.0	7.0	7.0		3.0	3.0
Lane Util. Factor	1.00	0.91	0.91		1.00	1.00
Frt	1.00	1.00	0.99		1.00	0.85
Flt Protected	0.95	1.00	1.00		0.95	1.00
Satd. Flow (prot)	1478	5079	4974		1465	1322
Flt Permitted	0.17	1.00	1.00		0.95	1.00
Satd. Flow (perm)	272	5079	4974		1465	1322
Peak-hour factor, PHF	1.00	1.00	1.00	1.00	1.00	1.00
Adj. Flow (vph)	85	1363	1345	57	75	167
RTOR Reduction (vph)	0	0	2	0	0	65
Lane Group Flow (vph)	85	1363	1400	0	75	102
Heavy Vehicles (%)	14%	1%	2%	14%	15%	14%
Turn Type	Perm	NA	NA		Prot	Perm
Protected Phases		2	6		4	
Permitted Phases	2					4
Actuated Green, G (s)	95.5	95.5	95.5		14.5	14.5
Effective Green, g (s)	95.5	95.5	95.5		14.5	14.5
Actuated g/C Ratio	0.80	0.80	0.80		0.12	0.12
Clearance Time (s)	7.0	7.0	7.0		3.0	3.0
Vehicle Extension (s)	3.0	3.0	3.0		3.0	3.0
Lane Grp Cap (vph)	216	4042	3958		177	159
v/s Ratio Prot		0.27	0.28		0.05	
v/s Ratio Perm	c0.31					c0.08
v/c Ratio	0.39	0.34	0.35		0.42	0.64
Uniform Delay, d1	3.6	3.4	3.5		48.9	50.3
Progression Factor	0.65	0.10	1.00		1.00	1.00
Incremental Delay, d2	4.4	0.2	0.2		1.6	8.5
Delay (s)	6.8	0.5	3.7		50.5	58.8
Level of Service	A	A	A		D	E
Approach Delay (s)		0.9	3.7		56.2	
Approach LOS		A	A		E	













Intersection Summary

HCM 2000 Control Delay	6.5	HCM 2000 Level of Service	A
HCM 2000 Volume to Capacity ratio	0.43		
Actuated Cycle Length (s)	120.0	Sum of lost time (s)	10.0
Intersection Capacity Utilization	56.4%	ICU Level of Service	B
Analysis Period (min)	15		

c Critical Lane Group

HCM Unsignalized Intersection Capacity Analysis
 26: Humber Station Road & Subject Lands Site Access #3

Future Total (2043) -Optimized
 PM Peak Hour

						
Movement	WBL	WBR	NBT	NBR	SBL	SBT
Lane Configurations						
Traffic Volume (veh/h)	88	54	622	54	30	242
Future Volume (Veh/h)	88	54	622	54	30	242
Sign Control	Stop		Free		Free	
Grade	0%		0%		0%	
Peak Hour Factor	1.00	1.00	1.00	1.00	1.00	1.00
Hourly flow rate (vph)	88	54	622	54	30	242
Pedestrians						
Lane Width (m)						
Walking Speed (m/s)						
Percent Blockage						
Right turn flare (veh)						
Median type	None			None		
Median storage veh)						
Upstream signal (m)						
pX, platoon unblocked						
vC, conflicting volume	924	622			676	
vC1, stage 1 conf vol						
vC2, stage 2 conf vol						
vCu, unblocked vol	924	622			676	
tC, single (s)	6.5	6.4			4.2	
tC, 2 stage (s)						
tF (s)	3.6	3.4			2.3	
p0 queue free %	68	88			97	
cM capacity (veh/h)	275	464			866	
Direction, Lane #	WB 1	WB 2	NB 1	NB 2	SB 1	SB 2
Volume Total	88	54	622	54	30	242
Volume Left	88	0	0	0	30	0
Volume Right	0	54	0	54	0	0
cSH	275	464	1700	1700	866	1700
Volume to Capacity	0.32	0.12	0.37	0.03	0.03	0.14
Queue Length 95th (m)	10.7	3.1	0.0	0.0	0.9	0.0
Control Delay (s)	24.1	13.8	0.0	0.0	9.3	0.0
Lane LOS	C	B			A	
Approach Delay (s)	20.2		0.0		1.0	
Approach LOS	C					
Intersection Summary						
Average Delay			2.9			
Intersection Capacity Utilization			44.3%		ICU Level of Service	A
Analysis Period (min)	15					

Queues
 27: Subject Lands Site Access #4 & Healey Road

Future Total (2043) -Optimized
 PM Peak Hour



Lane Group	EBT	WBL	WBT	NBL	NBR
Lane Configurations	↻	↻	↻	↻	↻
Traffic Volume (vph)	663	35	1208	72	64
Future Volume (vph)	663	35	1208	72	64
Lane Group Flow (vph)	708	35	1208	72	64
Turn Type	NA	Perm	NA	Prot	Perm
Protected Phases	4		8	2	
Permitted Phases		8			2
Detector Phase	4	8	8	2	2
Switch Phase					
Minimum Initial (s)	5.0	5.0	5.0	5.0	5.0
Minimum Split (s)	22.5	22.5	22.5	22.5	22.5
Total Split (s)	97.0	97.0	97.0	23.0	23.0
Total Split (%)	80.8%	80.8%	80.8%	19.2%	19.2%
Yellow Time (s)	3.5	3.5	3.5	3.5	3.5
All-Red Time (s)	1.0	1.0	1.0	1.0	1.0
Lost Time Adjust (s)	0.0	0.0	0.0	0.0	0.0
Total Lost Time (s)	4.5	4.5	4.5	4.5	4.5
Lead/Lag					
Lead-Lag Optimize?					
Recall Mode	C-Max	C-Max	C-Max	None	None
v/c Ratio	0.46	0.07	0.76	0.53	0.35
Control Delay	6.7	0.1	2.6	64.6	17.1
Queue Delay	0.0	0.0	0.0	0.0	0.0
Total Delay	6.7	0.1	2.6	64.6	17.1
Queue Length 50th (m)	55.6	0.1	11.0	17.3	0.0
Queue Length 95th (m)	100.2	m0.1	m2.5	31.8	13.2
Internal Link Dist (m)	505.1		823.7	346.9	
Turn Bay Length (m)		30.0		30.0	
Base Capacity (vph)	1555	488	1595	227	257
Starvation Cap Reductn	0	0	0	0	0
Spillback Cap Reductn	0	0	0	0	0
Storage Cap Reductn	0	0	0	0	0
Reduced v/c Ratio	0.46	0.07	0.76	0.32	0.25

Intersection Summary

Cycle Length: 120
 Actuated Cycle Length: 120
 Offset: 23 (19%), Referenced to phase 4:EBT and 8:WBTL, Start of Green
 Natural Cycle: 90
 Control Type: Actuated-Coordinated
 m Volume for 95th percentile queue is metered by upstream signal.

Splits and Phases: 27: Subject Lands Site Access #4 & Healey Road

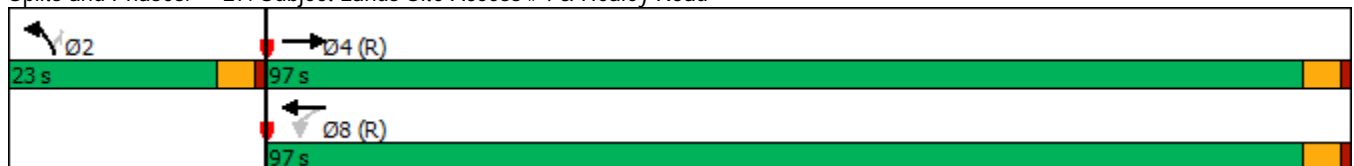

HCM Signalized Intersection Capacity Analysis
 27: Subject Lands Site Access #4 & Healey Road

Future Total (2043) -Optimized
 PM Peak Hour



Movement	EBT	EBR	WBL	WBT	NBL	NBR
Lane Configurations	↔		↖	↗	↖	↗
Traffic Volume (vph)	663	45	35	1208	72	64
Future Volume (vph)	663	45	35	1208	72	64
Ideal Flow (vphpl)	1900	1900	1900	1900	1900	1900
Lane Width	3.5	3.0	3.0	3.5	3.0	3.0
Total Lost time (s)	4.5		4.5	4.5	4.5	4.5
Lane Util. Factor	1.00		1.00	1.00	1.00	1.00
Frt	0.99		1.00	1.00	1.00	0.85
Flt Protected	1.00		0.95	1.00	0.95	1.00
Satd. Flow (prot)	1814		1478	1860	1478	1322
Flt Permitted	1.00		0.37	1.00	0.95	1.00
Satd. Flow (perm)	1814		569	1860	1478	1322
Peak-hour factor, PHF	1.00	1.00	1.00	1.00	1.00	1.00
Adj. Flow (vph)	663	45	35	1208	72	64
RTOR Reduction (vph)	1	0	0	0	0	59
Lane Group Flow (vph)	707	0	35	1208	72	5
Heavy Vehicles (%)	2%	13%	14%	1%	14%	14%
Turn Type	NA		Perm	NA	Prot	Perm
Protected Phases	4			8	2	
Permitted Phases			8			2
Actuated Green, G (s)	101.1		101.1	101.1	9.9	9.9
Effective Green, g (s)	101.1		101.1	101.1	9.9	9.9
Actuated g/C Ratio	0.84		0.84	0.84	0.08	0.08
Clearance Time (s)	4.5		4.5	4.5	4.5	4.5
Vehicle Extension (s)	3.0		3.0	3.0	3.0	3.0
Lane Grp Cap (vph)	1528		479	1567	121	109
v/s Ratio Prot	0.39			c0.65	c0.05	
v/s Ratio Perm			0.06			0.00
v/c Ratio	0.46		0.07	0.77	0.60	0.05
Uniform Delay, d1	2.4		1.6	4.2	53.1	50.7
Progression Factor	1.99		0.05	0.39	1.00	1.00
Incremental Delay, d2	0.8		0.0	0.3	7.6	0.2
Delay (s)	5.6		0.1	2.0	60.8	50.9
Level of Service	A		A	A	E	D
Approach Delay (s)	5.6			2.0	56.1	
Approach LOS	A			A	E	













Intersection Summary

HCM 2000 Control Delay	6.7	HCM 2000 Level of Service	A
HCM 2000 Volume to Capacity ratio	0.75		
Actuated Cycle Length (s)	120.0	Sum of lost time (s)	9.0
Intersection Capacity Utilization	75.2%	ICU Level of Service	D
Analysis Period (min)	15		

c Critical Lane Group

HCM Unsignalized Intersection Capacity Analysis
 28: Humber Station Road & Subject Lands Site Access #2

Future Total (2043) -Optimized
 PM Peak Hour

						
Movement	WBL	WBR	NBT	NBR	SBL	SBT
Lane Configurations						
Traffic Volume (veh/h)	7	5	671	5	2	328
Future Volume (Veh/h)	7	5	671	5	2	328
Sign Control	Stop		Free		Free	
Grade	0%		0%		0%	
Peak Hour Factor	1.00	1.00	1.00	1.00	1.00	1.00
Hourly flow rate (vph)	7	5	671	5	2	328
Pedestrians						
Lane Width (m)						
Walking Speed (m/s)						
Percent Blockage						
Right turn flare (veh)						
Median type	None			None		
Median storage (veh)						
Upstream signal (m)						
pX, platoon unblocked						
vC, conflicting volume	1003	671			676	
vC1, stage 1 conf vol						
vC2, stage 2 conf vol						
vCu, unblocked vol	1003	671			676	
tC, single (s)	6.5	6.4			4.1	
tC, 2 stage (s)						
tF (s)	3.6	3.5			2.2	
p0 queue free %	97	99			100	
cM capacity (veh/h)	254	427			925	
Direction, Lane #	WB 1	WB 2	NB 1	NB 2	SB 1	SB 2
Volume Total	7	5	671	5	2	328
Volume Left	7	0	0	0	2	0
Volume Right	0	5	0	5	0	0
cSH	254	427	1700	1700	925	1700
Volume to Capacity	0.03	0.01	0.39	0.00	0.00	0.19
Queue Length 95th (m)	0.7	0.3	0.0	0.0	0.1	0.0
Control Delay (s)	19.5	13.5	0.0	0.0	8.9	0.0
Lane LOS	C	B			A	
Approach Delay (s)	17.0		0.0	0.1		
Approach LOS	C					
Intersection Summary						
Average Delay			0.2			
Intersection Capacity Utilization			45.3%	ICU Level of Service	A	
Analysis Period (min)	15					

HCM Unsignalized Intersection Capacity Analysis
 29: Mayfield Road & Subject Lands Site Access #5

Future Total (2043) -Optimized
 PM Peak Hour

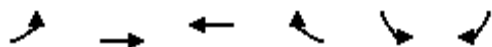

Movement	EBL	EBT	WBT	WBR	SBL	SBR				
Lane Configurations	↖	↑↑↑	↑↑↑↗		↙	↘				
Traffic Volume (veh/h)	12	1480	1743	8	14	20				
Future Volume (Veh/h)	12	1480	1743	8	14	20				
Sign Control		Free	Free		Stop					
Grade		0%	0%		0%					
Peak Hour Factor	1.00	1.00	1.00	1.00	1.00	1.00				
Hourly flow rate (vph)	12	1480	1743	8	14	20				
Pedestrians										
Lane Width (m)										
Walking Speed (m/s)										
Percent Blockage										
Right turn flare (veh)										
Median type		TWLTL	TWLTL							
Median storage (veh)		2	2							
Upstream signal (m)		265	147							
pX, platoon unblocked	0.88				0.87	0.88				
vC, conflicting volume	1751				2264	585				
vC1, stage 1 conf vol					1747					
vC2, stage 2 conf vol					517					
vCu, unblocked vol	1373				1001	46				
tC, single (s)	4.1				6.8	6.9				
tC, 2 stage (s)					5.8					
tF (s)	2.2				3.5	3.3				
p0 queue free %	97				92	98				
cM capacity (veh/h)	445				176	896				
Direction, Lane #	EB 1	EB 2	EB 3	EB 4	WB 1	WB 2	WB 3	SB 1	SB 2	
Volume Total	12	493	493	493	697	697	357	14	20	
Volume Left	12	0	0	0	0	0	0	14	0	
Volume Right	0	0	0	0	0	0	8	0	20	
cSH	445	1700	1700	1700	1700	1700	1700	176	896	
Volume to Capacity	0.03	0.29	0.29	0.29	0.41	0.41	0.21	0.08	0.02	
Queue Length 95th (m)	0.7	0.0	0.0	0.0	0.0	0.0	0.0	2.0	0.5	
Control Delay (s)	13.3	0.0	0.0	0.0	0.0	0.0	0.0	27.2	9.1	
Lane LOS	B							D	A	
Approach Delay (s)	0.1				0.0			16.6		
Approach LOS								C		
Intersection Summary										
Average Delay			0.2							
Intersection Capacity Utilization			43.9%	ICU Level of Service					A	
Analysis Period (min)			15							



**HUMBER STATION VILLAGES
LANDOWNERS GROUP**